

**NFPA<sup>®</sup>**

# 914

---

**Code for the  
Protection of  
Historic Structures**

---

**2019**



## IMPORTANT NOTICES AND DISCLAIMERS CONCERNING NFPA® STANDARDS

NFPA® codes, standards, recommended practices, and guides (“NFPA Standards”), of which the document contained herein is one, are developed through a consensus standards development process approved by the American National Standards Institute. This process brings together volunteers representing varied viewpoints and interests to achieve consensus on fire and other safety issues. While the NFPA administers the process and establishes rules to promote fairness in the development of consensus, it does not independently test, evaluate, or verify the accuracy of any information or the soundness of any judgments contained in NFPA Standards.

The NFPA disclaims liability for any personal injury, property, or other damages of any nature whatsoever, whether special, indirect, consequential or compensatory, directly or indirectly resulting from the publication, use of, or reliance on NFPA Standards. The NFPA also makes no guaranty or warranty as to the accuracy or completeness of any information published herein.

In issuing and making NFPA Standards available, the NFPA is not undertaking to render professional or other services for or on behalf of any person or entity. Nor is the NFPA undertaking to perform any duty owed by any person or entity to someone else. Anyone using this document should rely on his or her own independent judgment or, as appropriate, seek the advice of a competent professional in determining the exercise of reasonable care in any given circumstances.

The NFPA has no power, nor does it undertake, to police or enforce compliance with the contents of NFPA Standards. Nor does the NFPA list, certify, test, or inspect products, designs, or installations for compliance with this document. Any certification or other statement of compliance with the requirements of this document shall not be attributable to the NFPA and is solely the responsibility of the certifier or maker of the statement.

### REVISION SYMBOLS IDENTIFYING CHANGES FROM THE PREVIOUS EDITION

Text revisions are shaded. A **Δ** before a section number indicates that words within that section were deleted and a **Δ** to the left of a table or figure number indicates a revision to an existing table or figure. When a chapter was heavily revised, the entire chapter is marked throughout with the **Δ** symbol. Where one or more sections were deleted, a **•** is placed between the remaining sections. Chapters, annexes, sections, figures, and tables that are new are indicated with an **N**.

Note that these indicators are a guide. Rearrangement of sections may not be captured in the markup, but users can view complete revision details in the First and Second Draft Reports located in the archived revision information section of each code at [www.nfpa.org/docinfo](http://www.nfpa.org/docinfo). Any subsequent changes from the NFPA Technical Meeting, Tentative Interim Amendments, and Errata are also located there.

### REMINDER: UPDATING OF NFPA STANDARDS

Users of NFPA codes, standards, recommended practices, and guides (“NFPA Standards”) should be aware that these documents may be superseded at any time by the issuance of a new edition, may be amended with the issuance of Tentative Interim Amendments (TIAs), or be corrected by Errata. It is intended that through regular revisions and amendments, participants in the NFPA standards development process consider the then-current and available information on incidents, materials, technologies, innovations, and methods as these develop over time and that NFPA Standards reflect this consideration. Therefore, any previous edition of this document no longer represents the current NFPA Standard on the subject matter addressed. NFPA encourages the use of the most current edition of any NFPA Standard [as it may be amended by TIA(s) or Errata] to take advantage of current experience and understanding. An official NFPA Standard at any point in time consists of the current edition of the document, including any issued TIAs and Errata then in effect.

To determine whether an NFPA Standard has been amended through the issuance of TIAs or corrected by Errata, visit the “Codes & Standards” section at [www.nfpa.org](http://www.nfpa.org).

## **ADDITIONAL IMPORTANT NOTICES AND DISCLAIMERS CONCERNING NFPA® STANDARDS**

### **Updating of NFPA Standards**

Users of NFPA codes, standards, recommended practices, and guides (“NFPA Standards”) should be aware that these documents may be superseded at any time by the issuance of a new edition, may be amended with the issuance of Tentative Interim Amendments (TIAs), or be corrected by Errata. It is intended that through regular revisions and amendments, participants in the NFPA standards development process consider the then-current and available information on incidents, materials, technologies, innovations, and methods as these develop over time and that NFPA Standards reflect this consideration. Therefore, any previous edition of this document no longer represents the current NFPA Standard on the subject matter addressed. NFPA encourages the use of the most current edition of any NFPA Standard [as it may be amended by TIA(s) or Errata] to take advantage of current experience and understanding. An official NFPA Standard at any point in time consists of the current edition of the document, including any issued TIAs and Errata then in effect.

To determine whether an NFPA Standard has been amended through the issuance of TIAs or corrected by Errata, visit the “Codes & Standards” section at [www.nfpa.org](http://www.nfpa.org).

### **Interpretations of NFPA Standards**

A statement, written or oral, that is not processed in accordance with Section 6 of the Regulations Governing the Development of NFPA Standards shall not be considered the official position of NFPA or any of its Committees and shall not be considered to be, nor be relied upon as, a Formal Interpretation.

### **Patents**

The NFPA does not take any position with respect to the validity of any patent rights referenced in, related to, or asserted in connection with an NFPA Standard. The users of NFPA Standards bear the sole responsibility for determining the validity of any such patent rights, as well as the risk of infringement of such rights, and the NFPA disclaims liability for the infringement of any patent resulting from the use of or reliance on NFPA Standards.

NFPA adheres to the policy of the American National Standards Institute (ANSI) regarding the inclusion of patents in American National Standards (“the ANSI Patent Policy”), and hereby gives the following notice pursuant to that policy:

NOTICE: The user’s attention is called to the possibility that compliance with an NFPA Standard may require use of an invention covered by patent rights. NFPA takes no position as to the validity of any such patent rights or as to whether such patent rights constitute or include essential patent claims under the ANSI Patent Policy. If, in connection with the ANSI Patent Policy, a patent holder has filed a statement of willingness to grant licenses under these rights on reasonable and nondiscriminatory terms and conditions to applicants desiring to obtain such a license, copies of such filed statements can be obtained, on request, from NFPA. For further information, contact the NFPA at the address listed below.

### **Law and Regulations**

Users of NFPA Standards should consult applicable federal, state, and local laws and regulations. NFPA does not, by the publication of its codes, standards, recommended practices, and guides, intend to urge action that is not in compliance with applicable laws, and these documents may not be construed as doing so.

### **Copyrights**

NFPA Standards are copyrighted. They are made available for a wide variety of both public and private uses. These include both use, by reference, in laws and regulations, and use in private self-regulation, standardization, and the promotion of safe practices and methods. By making these documents available for use and adoption by public authorities and private users, the NFPA does not waive any rights in copyright to these documents.

Use of NFPA Standards for regulatory purposes should be accomplished through adoption by reference. The term “adoption by reference” means the citing of title, edition, and publishing information only. Any deletions, additions, and changes desired by the adopting authority should be noted separately in the adopting instrument. In order to assist NFPA in following the uses made of its documents, adopting authorities are requested to notify the NFPA (Attention: Secretary, Standards Council) in writing of such use. For technical assistance and questions concerning adoption of NFPA Standards, contact NFPA at the address below.

### **For Further Information**

All questions or other communications relating to NFPA Standards and all requests for information on NFPA procedures governing its codes and standards development process, including information on the procedures for requesting Formal Interpretations, for proposing Tentative Interim Amendments, and for proposing revisions to NFPA standards during regular revision cycles, should be sent to NFPA headquarters, addressed to the attention of the Secretary, Standards Council, NFPA, 1 Batterymarch Park, P.O. Box 9101, Quincy, MA 02269-9101; email: [stds\\_admin@nfpa.org](mailto:stds_admin@nfpa.org).

For more information about NFPA, visit the NFPA website at [www.nfpa.org](http://www.nfpa.org). All NFPA codes and standards can be viewed at no cost at [www.nfpa.org/docinfo](http://www.nfpa.org/docinfo).

Copyright © 2018 National Fire Protection Association®. All Rights Reserved.

## NFPA® 914

### Code for the

## Protection of Historic Structures

### 2019 Edition

This edition of NFPA 914, *Code for the Protection of Historic Structures*, was prepared by the Technical Committee on Cultural Resources. It was issued by the Standards Council on November 5, 2018, with an effective date of November 25, 2018, and supersedes all previous editions.

This edition of NFPA 914 was approved as an American National Standard on November 25, 2018.

### Origin and Development of NFPA 914

The Technical Committee on Cultural Resources was first organized in 1940 as the Committee on Libraries, Museums, and Historic Buildings. The first committee document, published in 1948, was the manual *Protecting Our Heritage: Historic Buildings, Museums, and Libraries*. A second edition of the manual was published in 1970.

The technical committee approved a request in November 1984 to develop a publication similar to NFPA 913, *Recommended Practice for the Protection of Historic Structures and Sites*. NFPA 913 was withdrawn in 1997, but its scope of coverage included protection criteria for historic structures for buildings that were to be rehabilitated for new uses. A recommended practice was prepared in draft form for the 1988 Annual Meeting but was not considered by the technical committee to be ready for publication. The technical committee continued to revise and organize the material, and the document was submitted once again at the 1989 Annual Meeting where the first edition was adopted. The original title was *Recommended Practice for Fire Protection in Rehabilitation and Adaptive Reuse of Historic Structures*.

In 1993, the technical committee moved to consolidate the various requirements for churches, museums, and libraries into a common standard. That consolidation was achieved in 1997 with the issuance of NFPA 909, *Standard for the Protection of Cultural Resources, Including Museums, Libraries, Places of Worship, and Historic Properties*. While this new standard was being developed, a further need to deal with the unique properties of historic structures was identified: in many applications, traditional requirements of codes and standards did not provide practical solutions to correcting fire protection deficiencies in historic properties.

Previous editions of NFPA 914 contained somewhat expanded fire protection guidelines, including the need to develop an overall fire protection plan that emphasized management's responsibility in addressing fire protection and the importance of preserving the historic integrity of these irreplaceable artifacts of history and culture. However, the document still did not contain a roadmap to accomplish these goals. The changes made to the 2001 edition of the document were quite substantial in this regard, including the designation of that edition as a code rather than as a recommended practice. The document gave clear guidance instead of good ideas. Designation as a code also allowed NFPA 914 to be adopted into law by a state or local jurisdiction, since it used mandatory language.

Given the unique nature of this document — an attempt to cover the gamut of existing structures with no occupancy change, structures that had been undergoing an adaptive reuse transformation, or those structures that simply had never been regulated before, given the lack of an authoritative document on this subject — the 2001 edition contained both a prescriptive approach as well as a performance-based approach to finding solutions to the life safety and fire safety problems in historic structures. In both cases, NFPA 914 maintained the importance of preventing or minimizing the intrusion of fire protection systems or solutions so as not to destroy the fabric or significance of the structure.

Also of significance in the 2001 edition was the addition of a process whereby individuals responsible for managing the fire protection plan for a building could be considered part of the

plan. This approach allowed specific direction to be given for a needs assessment, both from the fire protection management standpoint as well as from the historic significance standpoint. This process allowed the responsible parties to develop and implement a plan that encompassed all aspects of the historic structure or site so that it could be preserved for future generations. Guidance for this approach was added to the chapter on management operational systems.

The 2007 edition underwent a major reorganization to comply with the *Manual of Style for NFPA Technical Committee Documents* and to correlate better with the 2005 edition of NFPA 909, *Code for the Protection of Cultural Resource Properties — Museums, Libraries, and Places of Worship*. A new chapter on security and a new annex that illustrated compliance alternatives were added. Technical revisions were made pertaining to life safety performance criteria; temporary enclosures; deficiencies discovered during compliance audits; documentation of modifications to prescriptive requirements; housekeeping practices; hot work; cabling; commercial cooking and food service operations; additions, alterations, and repairs; roofing; plumbing; temporary wiring; fire doors; inspection, testing, and maintenance of fire protection systems; and the use of combustible packing materials. Revisions were also made regarding the type of automatic sprinklers to be used in historic structures properties, and information was added on management operations systems and emergency response plans.

The 2010 edition added criteria and survey forms for conducting vulnerability assessments to mitigate the risk of arson in historic structures; guidance on implementing operational controls; requirement for arc-fault circuit interrupters (AFCIs) to protect electrical circuits; criteria for protection against wildfires; criteria for the determination of contractor qualifications for working in historic structures; inspection, testing, and maintenance requirements for premises security systems; special event security and protection criteria; a new annex on case studies; a new annex on the protection of historic districts; a new annex on example code exceptions for historic buildings; and a new annex on security systems.

For the 2015 edition, the code's scope, goals, and objectives were revised to include security. Consistent with the revised scope, security requirements were revised, consolidated, and relocated to a new chapter on security following the chapter on fire prevention requirements. Plenum storage requirements were extracted from NFPA 90A, *Standard for the Installation of Air-Conditioning and Ventilating Systems*, and added to the chapter on fire prevention requirements.

For the 2019 edition, the title of NFPA 914 has been revised from *Code for Fire Protection of Historic Structures* to *Code for the Protection of Historic Structures*, and numerous provisions have been revised to reflect its expanded scope and purpose, which includes fire protection, security, and resiliency of historic structures and historic districts. New requirements for fire protection and life safety system commissioning and integrated fire protection and life safety system testing have been added.

## Technical Committee on Cultural Resources

**Donald C. Moeller**, *Chair*

The Fire Consultants, Inc., CA [E]  
Rep. California State Historical Building Safety Board

**Michael Coull**, *Secretary*

Heritage Fire and Safety Ltd., Scotland, United Kingdom [SE]  
Rep. Historic Scotland

**Clare Ray Allshouse**, City of Shoreline, Washington, WA [E]

**Nicholas Artim**, Fire-Safety Network, VT [SE]

**Eileen E. Brady**, Washington State University, ID [U]

**Robert A. Carotenuto**, The New York Botanical Garden, NY [U]

**Sheila Coppinger**, Chubb, NY [I]

**Bradford T. Cronin**, Newport Fire Department, RI [E]

Rep. Rhode Island Association of Fire Marshals

**Grant Crosby**, U.S. Department of the Interior, AK [E]

**Laura E. Doyle**, U.S. General Services Administration, DC [U]

**Daniel P. Finnegan**, Siemens Industry, Inc., IL [M]

Rep. National Electrical Manufacturers Association

**Deborah L. Freeland**, Arthur J. Gallagher & Company, CA [I]

**Mark Hopkins**, National Fire Sprinkler Association, MD [M]

**Daniel J. Hubert**, Amerex/Janus Fire Systems, IN [M]

Rep. Fire Suppression Systems Association

**Michael Kilby**, Smithsonian Institution, DC [U]

**Fred Leber**, AML Encore Corporation, Canada [SE]

**Helen R. Lowery**, DuPont Fire Extinguishants, OK [M]

Rep. Halon Alternatives Research Corporation

**Wayne D. Moore**, JENSEN HUGHES, RI [SE]

**Kevin D. Morin**, Code Consultants, Inc., NY [SE]

**Luca Nassi**, Italian National Fire Department, Italy [E]

**Daniel E. Nichols**, State of New York Metropolitan Transportation Authority, NY [E]

Rep. Metropolitan Transportation Authority

**Thomas F. Norton**, Norel Service Company, Inc., MA [M]

Rep. Automatic Fire Alarm Association, Inc.

**Chris Portway**, Pepperdine University, CA [U]

**Milosh T. Puchovsky**, Worcester Polytechnic Institute, MA [SE]

**Colin M. Robertson**, Ecclesiastical Insurance, Canada [I]

**Patricia A. Silence**, Colonial Williamsburg Foundation, VA [U]

**John M. Watts, Jr.**, Fire Safety Institute, VT [SE]

**Robert D. Wilson**, National Gallery of Art, DC [U]

### Alternates

**James H. Antell**, JENSEN HUGHES, Malaysia [SE]

(Alt. to Wayne D. Moore)

**Ronald P. Bertone**, Robson Forensic, FL [SE]

(Voting Alternate)

**Shane M. Clary**, Bay Alarm Company, CA [M]

(Alt. to Thomas F. Norton)

**Joseph Dafin**, U.S. General Services Administration, DC [U]

(Alt. to Laura E. Doyle)

**John C. Harrington**, FM Global, MA [I]

(Voting Alternate)

**Marilyn E. Kaplan**, Preservation Architecture, NY [SE]

(Alt. to John M. Watts, Jr.)

**Kevin J. Kelly**, Victaulic, PA [M]

(Alt. to Daniel J. Hubert)

**Todd J. Neitzel**, U.S. Department of the Interior, CO [E]

(Alt. to Grant Crosby)

**Joseph Plati**, Code Consultants, Inc., NY [SE]

(Alt. to Kevin D. Morin)

**Rodger Reiswig**, Johnson Controls, FL [M]

(Alt. to Daniel P. Finnegan)

### Nonvoting

**Russell B. Leavitt**, Telgian Corporation, AZ [SE]

Rep. TC on Sprinkler System Discharge Criteria

**Stefano Marsella**, National Fire Corps, Italy [SE]

**Stephen E. Bush**, Winchester, VA [SE]

(Member Emeritus)

**William Jackson**, Lanark, Scotland [SE]

(Member Emeritus)

**Danny L. McDaniel**, Colonial Williamsburg Foundation, VA [U]

(Member Emeritus)

**Gregory E. Harrington**, NFPA Staff Liaison

*This list represents the membership at the time the Committee was balloted on the final text of this edition. Since that time, changes in the membership may have occurred. A key to classifications is found at the back of the document.*

NOTE: Membership on a committee shall not in and of itself constitute an endorsement of the Association or any document developed by the committee on which the member serves.

**Committee Scope:** This Committee shall have primary responsibility for documents on fire safety and security for libraries, museums, places of worship, and historic structures and their contents, but shall not overlap the provisions of NFPA 101, *Life Safety Code*, and NFPA 731, *Standard for the Installation of Electronic Premises Security Systems*.

## Contents

<b>Chapter 1 Administration</b> .....	<b>914- 6</b>	10.10 Enforcement. ....	<b>914- 21</b>
1.1 Scope. ....	<b>914- 6</b>	10.11 Modification of Plan. ....	<b>914- 21</b>
1.2 Purpose. ....	<b>914- 6</b>	10.12 Procedures for Opening and Closing. ....	<b>914- 21</b>
1.3 Application. ....	<b>914- 6</b>	<b>Chapter 11 Fire Prevention</b> .....	<b>914- 21</b>
1.4 Equivalency. ....	<b>914- 6</b>	11.1 General. ....	<b>914- 21</b>
1.5 Enforcement. ....	<b>914- 6</b>	11.2 Decorations. ....	<b>914- 21</b>
<b>Chapter 2 Referenced Publications</b> .....	<b>914- 7</b>	11.3 Fire Spread Control. ....	<b>914- 21</b>
2.1 General. ....	<b>914- 7</b>	11.4 Housekeeping. ....	<b>914- 21</b>
2.2 NFPA Publications. ....	<b>914- 7</b>	11.5 Smoking. ....	<b>914- 22</b>
2.3 Other Publications. ....	<b>914- 7</b>	11.6 Open Flame Use. ....	<b>914- 22</b>
2.4 References for Extracts in Mandatory Sections. ....	<b>914- 8</b>	11.7 Electrical Systems. ....	<b>914- 22</b>
<b>Chapter 3 Definitions</b> .....	<b>914- 8</b>	11.8 Cabling. ....	<b>914- 23</b>
3.1 General. ....	<b>914- 8</b>	11.9 Heating, Ventilating, and Air-Conditioning (HVAC) Systems. ....	<b>914- 23</b>
3.2 NFPA Official Definitions. ....	<b>914- 8</b>	11.10 Commercial Cooking and Food Service Operations. ....	<b>914- 23</b>
3.3 General Definitions. ....	<b>914- 8</b>	11.11 Access. ....	<b>914- 23</b>
<b>Chapter 4 General</b> .....	<b>914- 12</b>	11.12 Fire Proofing. ....	<b>914- 23</b>
4.1 Goals and Objectives. ....	<b>914- 12</b>	11.13 Lightning Protection. ....	<b>914- 23</b>
4.2 Goals. ....	<b>914- 12</b>	11.14 Protection from Wildland Fires. ....	<b>914- 23</b>
4.3 Objectives. ....	<b>914- 12</b>	11.15 Water Control. ....	<b>914- 24</b>
4.4 Compliance Options. ....	<b>914- 12</b>	<b>Chapter 12 Security</b> .....	<b>914- 24</b>
4.5 Materials. ....	<b>914- 12</b>	12.1 Security Systems. ....	<b>914- 24</b>
<b>Chapter 5 Reserved</b> .....	<b>914- 13</b>	12.2 Access Control. ....	<b>914- 24</b>
<b>Chapter 6 Reserved</b> .....	<b>914- 13</b>	12.3 Video Surveillance Systems. ....	<b>914- 24</b>
<b>Chapter 7 Process</b> .....	<b>914- 13</b>	12.4 Exterior Lighting Systems. ....	<b>914- 24</b>
7.1 General. ....	<b>914- 13</b>	12.5 Construction Areas. ....	<b>914- 24</b>
7.2 Project Team. ....	<b>914- 13</b>	<b>Chapter 13 Additions, Alterations, and Rehabilitation</b> .....	<b>914- 24</b>
7.3 Assessment. ....	<b>914- 13</b>	13.1 General. ....	<b>914- 24</b>
7.4 Options. ....	<b>914- 15</b>	13.2 Construction Oversight. ....	<b>914- 24</b>
7.5 Option Appraisal and Selection. ....	<b>914- 15</b>	13.3 Fire Protection and Life Safety Systems Commissioning. ....	<b>914- 25</b>
7.6 Design Review. ....	<b>914- 15</b>	13.4 Fire Spread Control. ....	<b>914- 25</b>
7.7 Initial Compliance Audit. ....	<b>914- 15</b>	13.5 Fire Protection Systems. ....	<b>914- 25</b>
7.8 Approval. ....	<b>914- 15</b>	13.6 Roof Coverings. ....	<b>914- 25</b>
7.9 Periodic Compliance Audit. ....	<b>914- 15</b>	13.7 Electrical Systems. ....	<b>914- 25</b>
<b>Chapter 8 Prescriptive-Based Approach</b> .....	<b>914- 15</b>	13.8 Hazardous Areas. ....	<b>914- 26</b>
8.1 General. ....	<b>914- 15</b>	13.9 Interior Finishes. ....	<b>914- 26</b>
8.2 Compensatory Features. ....	<b>914- 15</b>	13.10 Lightning Protection. ....	<b>914- 26</b>
<b>Chapter 9 Performance-Based Approach</b> .....	<b>914- 16</b>	13.11 Protection from Wildland Fires. ....	<b>914- 26</b>
9.1 General. ....	<b>914- 16</b>	13.12 Integrated Fire Protection and Life Safety Systems. ....	<b>914- 26</b>
9.2 Performance Criteria. ....	<b>914- 16</b>	13.13 Water Control. ....	<b>914- 26</b>
9.3 Retained Prescriptive Requirements. ....	<b>914- 16</b>	<b>Chapter 14 Fire Precautions During Construction,     Repair, and Alterations</b> .....	<b>914- 26</b>
9.4 Design Specifications and Other Conditions. ...	<b>914- 16</b>	14.1 General. ....	<b>914- 26</b>
9.5 Design Fire Scenarios. ....	<b>914- 17</b>	14.2 Fire Protection Systems. ....	<b>914- 26</b>
9.6 Evaluation of Proposed Design. ....	<b>914- 18</b>	14.3 Precautions. ....	<b>914- 26</b>
9.7 Safety Factors. ....	<b>914- 19</b>	14.4 Temporary Construction and Equipment. ....	<b>914- 28</b>
9.8 Documentation Requirements. ....	<b>914- 19</b>	14.5 Construction Processes and Hazards. ....	<b>914- 28</b>
9.9 Records. ....	<b>914- 19</b>	14.6 Fire Resistive Construction. ....	<b>914- 29</b>
9.10 Security Planning. ....	<b>914- 19</b>	14.7 Fire Suppression. ....	<b>914- 29</b>
9.11 Security Plan. ....	<b>914- 19</b>	14.8 Water Supply. ....	<b>914- 30</b>
<b>Chapter 10 Management Operational Systems</b> .....	<b>914- 19</b>	14.9 Standpipe Systems. ....	<b>914- 30</b>
10.1 General. ....	<b>914- 19</b>	14.10 Automatic Fire Suppression Systems. ....	<b>914- 30</b>
10.2 Responsibility/Authority. ....	<b>914- 20</b>	14.11 Portable Fire Extinguishers. ....	<b>914- 30</b>
10.3 Management Plan. ....	<b>914- 20</b>	14.12 Emergency Communication. ....	<b>914- 30</b>
10.4 Operational Requirements. ....	<b>914- 20</b>	<b>Chapter 15 Inspection, Testing, and Maintenance</b> .....	<b>914- 30</b>
10.5 Fire Emergency Response Plan. ....	<b>914- 20</b>	15.1 General. ....	<b>914- 30</b>
10.6 Training. ....	<b>914- 20</b>	15.2 Responsibility. ....	<b>914- 30</b>
10.7 Drills. ....	<b>914- 20</b>	15.3 Fire Protection Systems. ....	<b>914- 30</b>
10.8 Record Keeping. ....	<b>914- 20</b>		
10.9 Periodic Compliance Audit. ....	<b>914- 21</b>		

15.4	Impairments to Fire Protection Systems. ....	914– 31	<b>Annex H</b>	<b>Methods to Determine Untenable Conditions</b> .....	914– 72
15.5	Electronic Premises Security Systems. ....	914– 31			
15.6	Heating, Air-Conditioning, and Cooking Equipment. ....	914– 31	<b>Annex I</b>	<b>Assessment Methods</b> .....	914– 73
15.7	Chimneys. ....	914– 31	<b>Annex J</b>	<b>Fire Safety Inspection Forms</b> .....	914– 76
15.8	Electrical Systems. ....	914– 32	<b>Annex K</b>	<b>Fire System Maintenance Checklists</b> .....	914– 78
15.9	Fire Walls and Fire Barrier Walls. ....	914– 32	<b>Annex L</b>	<b>Sensitivity and Uncertainty Analysis and Safety Factors</b> .....	914– 82
15.10	Fire-Retardant-Treated Materials. ....	914– 32			
15.11	Fire Extinguishers. ....	914– 32	<b>Annex M</b>	<b>Sample Ordinance Adopting NFPA 914</b> ....	914– 83
<b>Chapter 16</b>	<b>Special Events</b> .....	914– 32	<b>Annex N</b>	<b>Secretary of the Interior’s Standards</b> .....	914– 83
16.1	General. ....	914– 32	<b>Annex O</b>	<b>Guideline on Fire Ratings of Archaic Materials and Assemblies</b> .....	914– 83
16.2	Occupant Loading. ....	914– 32	<b>Annex P</b>	<b>BSI Timber Panel Door Standard</b> .....	914– 84
16.3	Means of Egress. ....	914– 32	<b>Annex Q</b>	<b>Protection of Iconic Structures (Reserved)</b> .....	914– 92
16.4	Commercial Cooking and Food Service Operations. ....	914– 32	<b>Annex R</b>	<b>NFPA 914 Case Studies</b> .....	914– 92
16.5	Smoking. ....	914– 32	<b>Annex S</b>	<b>Protection of Historic Districts</b> .....	914– 94
16.6	Fireworks. ....	914– 32	<b>Annex T</b>	<b>Example Code Exceptions for Historic Buildings</b> .....	914– 100
16.7	Combustibles. ....	914– 32	<b>Annex U</b>	<b>Security Systems</b> .....	914– 102
16.8	Electrical Equipment. ....	914– 32	<b>Annex V</b>	<b>Informational References</b> .....	914– 122
16.9	Use of Historic Structures by Others. ....	914– 32	<b>Index</b>	.....	914– 125
<b>Annex A</b>	<b>Explanatory Material</b> .....	914– 33			
<b>Annex B</b>	<b>Planning and Design Appraisal</b> .....	914– 52			
<b>Annex C</b>	<b>Survey Criteria for a Historic Structure</b> ....	914– 56			
<b>Annex D</b>	<b>Basics of Fire and Fire Protection Systems</b> .....	914– 60			
<b>Annex E</b>	<b>Resources for Protection of Cultural Resource Property Projects</b> .....	914– 66			
<b>Annex F</b>	<b>Examples of Compliance Alternatives</b> .....	914– 67			
<b>Annex G</b>	<b>Performance-Based Fire Safety Code Compliance.</b> .....	914– 72			



## NFPA 914

## Code for the

## Protection of Historic Structures

## 2019 Edition

**IMPORTANT NOTE:** This NFPA document is made available for use subject to important notices and legal disclaimers. These notices and disclaimers appear in all publications containing this document and may be found under the heading “Important Notices and Disclaimers Concerning NFPA Standards.” They can also be viewed at [www.nfpa.org/disclaimers](http://www.nfpa.org/disclaimers) or obtained on request from NFPA.

**UPDATES, ALERTS, AND FUTURE EDITIONS:** New editions of NFPA codes, standards, recommended practices, and guides (i.e., NFPA Standards) are released on scheduled revision cycles. This edition may be superseded by a later one, or it may be amended outside of its scheduled revision cycle through the issuance of Tentative Interim Amendments (TIAs). An official NFPA Standard at any point in time consists of the current edition of the document, together with all TIAs and Errata in effect. To verify that this document is the current edition or to determine if it has been amended by TIAs or Errata, please consult the National Fire Codes® Subscription Service or the “List of NFPA Codes & Standards” at [www.nfpa.org/docinfo](http://www.nfpa.org/docinfo). In addition to TIAs and Errata, the document information pages also include the option to sign up for alerts for individual documents and to be involved in the development of the next edition.

**NOTICE:** An asterisk (\*) following the number or letter designating a paragraph indicates that explanatory material on the paragraph can be found in Annex A.

A reference in brackets [ ] following a section or paragraph indicates material that has been extracted from another NFPA document. As an aid to the user, the complete title and edition of the source documents for extracts in mandatory sections of the document are given in Chapter 2 and those for extracts in informational sections are given in Annex V. Extracted text may be edited for consistency and style and may include the revision of internal paragraph references and other references as appropriate. Requests for interpretations or revisions of extracted text shall be sent to the technical committee responsible for the source document.

Information on referenced publications can be found in Chapter 2 and Annex V.

## Chapter 1 Administration

## 1.1 Scope.

**1.1.1** This code describes principles and practices of protection and recovery for historic structures and districts.

**1.1.2\*** Collections within libraries, museums, and places of worship are not within the scope of this code.

**Δ 1.2\* Purpose.** This code prescribes minimum requirements for the protection and recovery of historic structures from vulnerabilities while preserving the elements, spaces, and features that make these structures historically or architecturally significant.

**1.3 Application.** This code applies to historic structures.

**1.3.1** This code covers ongoing operations, renovation, and restoration and acknowledges the need to preserve historically

significant and character-defining building features and to provide for continuity of operations.

**1.3.2** This code addresses those construction, protection, operational, and occupancy features that are necessary to minimize danger to life, structures, and historic fabric from the effects of fire and other vulnerabilities.

**1.3.3** This code identifies the minimum fire and security criteria to permit prompt escape of the building occupants to a safe area and to minimize the impact of fire, damage from fire protection equipment, and security vulnerabilities to the structure or historic fabric.

**1.3.4** The application of the security requirements of this code is based on the risk considerations determined in Chapter 9.

**1.3.5** Libraries, museums, and places of worship housed in historic structures shall also comply with the requirements of NFPA 909.

## 1.4 Equivalency.

**1.4.1** Nothing in this code is intended to prevent the use of systems, methods, or devices of equivalent or superior quality, strength, fire resistance, or effectiveness, provided that the following conditions are met:

- (1) Technical documentation shall be submitted to the authority having jurisdiction to demonstrate equivalency.
- (2) The system, method, or device shall be approved for the intended purpose by the authority having jurisdiction.

**1.4.2** Historic structures or portions of such structures that do not strictly comply with this code shall be considered to be in compliance if it can be shown that equivalent protection has been provided or that no specific hazard or security threat will be created or continued through noncompliance.

**1.4.3** A designer capable of applying more complete and rigorous analysis to special or unusual problems shall have latitude in the development of the applicable design.

**1.4.3.1** In such cases, the designer shall be responsible for demonstrating the validity of the approach.

**1.4.3.2** This code shall not do away with the need for competent engineering judgment.

**1.4.3.3** This code shall not be intended to be used as a design handbook.

**1.5\* Enforcement.** This code shall be administered and enforced by the AHJ designated by the governing authority.

## 1.5.1 Organization.

**1.5.1.1** The owner or governing body shall designate a fire safety manager who shall administer and enforce the fire safety requirements of this code.

**1.5.1.2** The owner or governing body shall designate a security manager who shall administer and enforce the security requirements of this code.

**1.5.2 Approvals by Other Authorities Having Jurisdiction.** The fire safety manager shall require that the laws, rules, and regulations of all other regulatory agencies having jurisdiction shall be met when not in conflict with this code.

## Chapter 2 Referenced Publications

**2.1 General.** The documents or portions thereof listed in this chapter are referenced within this code and shall be considered part of the requirements of this document.

**2.2 NFPA Publications.** National Fire Protection Association, 1 Batterymarch Park, Quincy, MA 02169-7471.

- NFPA 1, *Fire Code*, 2018 edition.
- NFPA 3, *Standard for Commissioning of Fire Protection and Life Safety Systems*, 2018 edition.
- NFPA 4, *Standard for Integrated Fire Protection and Life Safety System Testing*, 2018 edition.
- NFPA 10, *Standard for Portable Fire Extinguishers*, 2018 edition.
- NFPA 11, *Standard for Low-, Medium-, and High-Expansion Foam*, 2016 edition.
- NFPA 12, *Standard on Carbon Dioxide Extinguishing Systems*, 2018 edition.
- NFPA 12A, *Standard on Halon 1301 Fire Extinguishing Systems*, 2018 edition.
- NFPA 13, *Standard for the Installation of Sprinkler Systems*, 2019 edition.
- NFPA 13D, *Standard for the Installation of Sprinkler Systems in One- and Two-Family Dwellings and Manufactured Homes*, 2019 edition.
- NFPA 13R, *Standard for the Installation of Sprinkler Systems in Low-Rise Residential Occupancies*, 2019 edition.
- NFPA 14, *Standard for the Installation of Standpipe and Hose Systems*, 2019 edition.
- NFPA 15, *Standard for Water Spray Fixed Systems for Fire Protection*, 2017 edition.
- NFPA 16, *Standard for the Installation of Foam-Water Sprinkler and Foam-Water Spray Systems*, 2015 edition.
- NFPA 17, *Standard for Dry Chemical Extinguishing Systems*, 2017 edition.
- NFPA 17A, *Standard for Wet Chemical Extinguishing Systems*, 2017 edition.
- NFPA 25, *Standard for the Inspection, Testing, and Maintenance of Water-Based Fire Protection Systems*, 2017 edition.
- NFPA 30, *Flammable and Combustible Liquids Code*, 2018 edition.
- NFPA 31, *Standard for the Installation of Oil-Burning Equipment*, 2016 edition.
- NFPA 51B, *Standard for Fire Prevention During Welding, Cutting, and Other Hot Work*, 2019 edition.
- NFPA 54, *National Fuel Gas Code*, 2018 edition.
- NFPA 58, *Liquefied Petroleum Gas Code*, 2017 edition.
- NFPA 70®, *National Electrical Code®*, 2017 edition.
- NFPA 72®, *National Fire Alarm and Signaling Code®*, 2019 edition.
- NFPA 80, *Standard for Fire Doors and Other Opening Protectives*, 2019 edition.
- NFPA 90A, *Standard for the Installation of Air-Conditioning and Ventilating Systems*, 2018 edition.
- NFPA 90B, *Standard for the Installation of Warm Air Heating and Air-Conditioning Systems*, 2018 edition.
- NFPA 92, *Standard for Smoke Control Systems*, 2018 edition.
- NFPA 96, *Standard for Ventilation Control and Fire Protection of Commercial Cooking Operations*, 2017 edition.
- NFPA 101®, *Life Safety Code®*, 2018 edition.
- NFPA 110, *Standard for Emergency and Standby Power Systems*, 2019 edition.

NFPA 204, *Standard for Smoke and Heat Venting*, 2018 edition.  
 NFPA 211, *Standard for Chimneys, Fireplaces, Vents, and Solid Fuel-Burning Appliances*, 2019 edition.

NFPA 241, *Standard for Safeguarding Construction, Alteration, and Demolition Operations*, 2019 edition.

NFPA 259, *Standard Test Method for Potential Heat of Building Materials*, 2018 edition.

NFPA 289, *Standard Method of Fire Test for Individual Fuel Packages*, 2019 edition.

NFPA 701, *Standard Methods of Fire Tests for Flame Propagation of Textiles and Films*, 2019 edition.

NFPA 703, *Standard for Fire Retardant-Treated Wood and Fire-Retardant Coatings for Building Materials*, 2018 edition.

NFPA 731, *Standard for the Installation of Electronic Premises Security Systems*, 2017 edition.

NFPA 750, *Standard on Water Mist Fire Protection Systems*, 2019 edition.

NFPA 780, *Standard for the Installation of Lightning Protection Systems*, 2017 edition.

NFPA 909, *Code for the Protection of Cultural Resource Properties — Museums, Libraries, and Places of Worship*, 2017 edition.

NFPA 1123, *Code for Fireworks Display*, 2018 edition.

NFPA 1126, *Standard for the Use of Pyrotechnics Before a Proximate Audience*, 2016 edition.

NFPA 1144, *Standard for Reducing Structure Ignition Hazards from Wildland Fire*, 2018 edition.

NFPA 2001, *Standard on Clean Agent Fire Extinguishing Systems*, 2018 edition.

### 2.3 Other Publications.

▲ **2.3.1 ANSI/UL Publications.** Underwriters Laboratories Inc., 333 Pfingsten Road, Northbrook, IL 60062-2096.

ANSI/UL 263, *Standard for Fire Tests of Building Construction and Materials*, 2014.

ANSI/UL 723, *Standard for Test for Surface Burning Characteristics of Building Materials*, 2008, revised 2013.

UL 1975, *Standard for Fire Tests for Foamed Plastics Used for Decorative Purposes*, 2006.

■ **2.3.2 ASCE Publications.** American Society of Civil Engineers, 1801 Alexander Bell Drive, Reston, VA 20191-4400.

ASCE/SEI 7, *Minimum Design Loads for Buildings and Other Structures*, 2010.

▲ **2.3.3 ASTM Publications.** ASTM International, 100 Barr Harbor Drive, P.O. Box C700, West Conshohocken, PA 19428-2959.

ASTM E84, *Standard Test Method for Surface Burning Characteristics of Building Materials*, 2016.

ASTM E119, *Standard Test Methods for Fire Tests of Building Construction and Materials*, 2016a.

ASTM E136, *Standard Test Method for Behavior of Materials in a Vertical Tube Furnace at 750°C*, 2016a.

ASTM E1591, *Standard Guide for Obtaining Data for Fire Growth Models*, 2013.

ASTM E2652, *Standard Test Method for Behavior of Materials in a Tube Furnace with a Cone-shaped Airflow Stabilizer, at 750°C*, 2016.

ASTM E2965, *Standard Test Method for Determination of Low Levels of Heat Release Rate for Materials and Products Using an Oxygen Consumption Calorimeter*, 2016.

### 2.3.4 Other Publications.

*Merriam-Webster's Collegiate Dictionary*, 11th edition, Merriam-Webster, Inc., Springfield, MA, 2003.

## 2.4 References for Extracts in Mandatory Sections.

- NFPA 1, *Fire Code*, 2018 edition.
- NFPA 3, *Standard for Commissioning of Fire Protection and Life Safety Systems*, 2018 edition.
- NFPA 4, *Standard for Integrated Fire Protection and Life Safety System Testing*, 2018 edition.
- NFPA 13, *Standard for the Installation of Sprinkler Systems*, 2019 edition.
- NFPA 25, *Standard for the Inspection, Testing, and Maintenance of Water-Based Fire Protection Systems*, 2017 edition.
- NFPA 51B, *Standard for Fire Prevention During Welding, Cutting, and Other Hot Work*, 2019 edition.
- NFPA 70®, *National Electrical Code®*, 2017 edition.
- NFPA 72®, *National Fire Alarm and Signaling Code®*, 2019 edition.
- NFPA 90A, *Standard for the Installation of Air-Conditioning and Ventilating Systems*, 2018 edition.
- NFPA 101®, *Life Safety Code®*, 2018 edition.
- NFPA 557, *Standard for Determination of Fire Loads for Use in Structural Fire Protection Design*, 2016 edition.
- NFPA 730, *Guide for Premises Security*, 2018 edition.
- NFPA 731, *Standard for the Installation of Electronic Premises Security Systems*, 2017 edition.
- NFPA 805, *Performance-Based Standard for Fire Protection for Light Water Reactor Electric Generating Plants*, 2015 edition.
- NFPA 921, *Guide for Fire and Explosion Investigations*, 2017 edition.
- NFPA 1141, *Standard for Fire Protection Infrastructure for Land Development in Wildland, Rural, and Suburban Areas*, 2017 edition.
- NFPA 5000®, *Building Construction and Safety Code®*, 2018 edition.

## Chapter 3 Definitions

**3.1 General.** The definitions contained in this chapter shall apply to the terms used in this code. Where terms are not defined in this chapter or within another chapter, they shall be defined using their ordinarily accepted meanings within the context in which they are used. *Merriam-Webster's Collegiate Dictionary*, 11th edition, shall be the source for the ordinarily accepted meaning.

### 3.2 NFPA Official Definitions.

**3.2.1\* Approved.** Acceptable to the authority having jurisdiction.

**3.2.2\* Authority Having Jurisdiction (AHJ).** An organization, office, or individual responsible for enforcing the requirements of a code or standard, or for approving equipment, materials, an installation, or a procedure.

**3.2.3\* Code.** A standard that is an extensive compilation of provisions covering broad subject matter or that is suitable for adoption into law independently of other codes and standards.

**3.2.4 Labeled.** Equipment or materials to which has been attached a label, symbol, or other identifying mark of an organization that is acceptable to the authority having jurisdiction and concerned with product evaluation, that maintains periodic inspection of production of labeled equipment or materials, and by whose labeling the manufacturer indicates compliance with appropriate standards or performance in a specified manner.

**3.2.5\* Listed.** Equipment, materials, or services included in a list published by an organization that is acceptable to the authority having jurisdiction and concerned with evaluation of products or services, that maintains periodic inspection of production of listed equipment or materials or periodic evaluation of services, and whose listing states that either the equipment, material, or service meets appropriate designated standards or has been tested and found suitable for a specified purpose.

**3.2.6 Shall.** Indicates a mandatory requirement.

**3.2.7 Should.** Indicates a recommendation or that which is advised but not required.

**3.2.8 Standard.** An NFPA Standard, the main text of which contains only mandatory provisions using the word “shall” to indicate requirements and that is in a form generally suitable for mandatory reference by another standard or code or for adoption into law. Nonmandatory provisions are not to be considered a part of the requirements of a standard and shall be located in an appendix, annex, footnote, informational note, or other means as permitted in the NFPA Manuals of Style. When used in a generic sense, such as in the phrase “standards development process” or “standards development activities,” the term “standards” includes all NFPA Standards, including Codes, Standards, Recommended Practices, and Guides.

### 3.3 General Definitions.

**3.3.1 Access Control.** The act of managing ingress or egress through a portal by validating a credential or an individual. [731, 2017]

**3.3.2 Adaptive Reuse.** The conversion or functional change of a building from the purpose or use for which it was originally constructed or designed.

**3.3.3 Addition.** An increase in the building area, aggregate floor area, building height, or number of stories of a structure. [5000, 2018]

- **3.3.4 Arc-Fault Circuit Interrupter (AFCI).** A device intended to provide protection from the effects of arc faults by recognizing characteristics unique to arcing and by functioning to de-energize the circuit when an arc fault is detected. [70:100]

**3.3.5 Arson.** The crime of maliciously and intentionally, or recklessly, starting a fire or causing an explosion. [921, 2017]

**3.3.6\* Atrium.** A large-volume space created by a floor opening or series of floor openings connecting two or more stories that is covered at the top of the series of openings and is used for purposes other than an enclosed stairway; an elevator hoistway; an escalator opening; or as a utility shaft used for plumbing, electrical, air-conditioning, or communications facilities. [101, 2018]

### 3.3.7 Barrier.

**3.3.7.1\* Fire Barrier.** A continuous membrane or a membrane with discontinuities created by protected openings with a specified fire protection rating, where such membrane is designed and constructed with a specified fire resistance rating to limit the spread of fire. [101, 2018]

**3.3.7.2\* Smoke Barrier.** A continuous membrane, or a membrane with discontinuities created by protected openings, where such membrane is designed and constructed to restrict the movement of smoke. [101, 2018]

**3.3.8 Building Manager.** The authorized person, formally and officially appointed or designated by the governing body or a responsible party, who is charged with the duties and responsibilities of providing and ensuring the overall management, operation, and maintenance for that facility or institution.

**3.3.9\* Building Systems.** An assembly or set of units made up of components that provide services to spaces in a building.

**3.3.10\* Buildings.** Structures, usually enclosed by walls and a roof, constructed to provide support or shelter for an intended occupancy.

**3.3.11 Character-Defining Feature.** A prominent or distinctive aspect, quality, or characteristic of a cultural resource property that contributes significantly to its physical character.

**3.3.12 Collections.** Prehistoric and historic objects, works of art, scientific specimens, religious objects, archival documents, archeological artifacts, library media, and cultural materials assembled according to some rational scheme and maintained for the purpose of preservation, research, study, exhibition, publication, or interpretation.

**N 3.3.13 Commissioning (Cx).** A systematic process that provides documented confirmation that building systems function according to the intended design criteria set forth in the project documents and satisfy the owner's operational needs, including compliance with governing laws, regulations, codes, and standards. [3, 2018]

**3.3.14 Compartment.** See 3.3.29, Fire Compartment.

**3.3.15 Compliance.** Adherence or conformance to laws and standards.

**3.3.16\* Conservation.** The professional practice of examination, documentation, treatment, and preventative care devoted to the preservation of cultural property.

**3.3.17 Cultural Landscape.** A geographic area (including both cultural and natural resources and the wildlife or domestic animals therein) associated with a historic event, activity, or person, or exhibiting other cultural or aesthetic values.

**3.3.18\* Cultural Resource Properties.** Buildings, structures, or sites, or portions thereof, that are culturally significant, or that house culturally significant collections for museums, libraries, and places of worship.

**3.3.19 Damage Limitation Plan.** Written procedures that outline and prioritize the actions to take following a disaster to minimize property damage and loss.

**3.3.20\* Design Specification.** A building characteristic and other conditions that are under the control of the design team. [101, 2018]

**3.3.21\* Design Team.** A group of stakeholders including, but not limited to, representatives of the architect, client, and any pertinent engineers and other designers. [101, 2018]

**3.3.22 Early Warning.** A signal provided by a system that detects fire in its earliest stages of development to enhance the opportunity of building occupants to escape and to commence manual suppression of the fire prior to arrival of fire service units.

**3.3.23 Equivalency.** An alternative means of providing an equal or greater degree of safety than that afforded by strict conformance to prescribed codes and standards. [101, 2018]

**3.3.24 Exit.** That portion of a means of egress that is separated from all other spaces of the building or structure by construction, location, or equipment as required to provide a protected way of travel to the exit discharge. [101, 2018]

**3.3.25 Exit Access.** That portion of a means of egress that leads to an exit. [101, 2018]

**3.3.26 Exit Discharge.** That portion of a means of egress between the termination of an exit and a public way. [101, 2018]

**3.3.27\* Exposure Fire.** A fire that starts at a location that is remote from the area being protected and grows to expose that which is being protected. [101, 2018]

**3.3.28\* Feature (Cultural Landscape).** The smallest element(s) of a landscape that contributes to the significance and that can be the subject of a treatment intervention.

**3.3.29 Fire Compartment.** A space within a building that is enclosed by fire barriers on all sides, including the top and bottom. [5000, 2018]

**3.3.30 Fire Hazard.** Any situation, process, material, or condition that, on the basis of applicable data, can cause a fire or explosion or that can provide a ready fuel supply to augment the spread or intensity of a fire or explosion, all of which pose a threat to life or property.

**3.3.31 Fire Load.** The total energy content of combustible materials in a building, space, or area including furnishing and contents and combustible building elements expressed in MJ. [557, 2016]

**3.3.32\* Fire Model.** Mathematical prediction of fire growth, environmental conditions, and potential effects on structures, systems, or components based on the conservation equations or empirical data. [805, 2015]

**3.3.33 Fire Resistance Rating.** The time, in minutes or hours, that materials or assemblies have withstood a fire exposure as established in accordance with the test procedures of ASTM E119, *Standard Test Methods for Fire Tests of Building Construction and Materials*, or ANSI/UL 263, *Standard for Fire Tests of Building Construction and Materials*.

**3.3.34 Fire Resistive.** Property or design to resist the effects of any fire to which a material or structure can be expected to be subjected.

**3.3.35 Fire Retardant.** A liquid, solid, or gas that tends to inhibit combustion when applied on, mixed in, or combined with combustible materials. [1, 2018]

**3.3.36\* Fire Safety Manager.** A person identified by the governing body who is responsible for developing, implement-

ing, exercising, and conducting routine evaluations of fire safety provisions of the code.

**▲ 3.3.37 Fire Watch.** The assignment of a person or persons to an area for the express purpose of notifying the fire department, the building occupants, or both of an emergency; preventing a fire from occurring; extinguishing small fires; protecting the public from fire and life safety dangers. [1, 2018]

**3.3.38 Firestop.** A specific system, device, or construction consisting of the materials that fill the openings around penetrating items such as cables, cable trays, conduits, ducts, pipes, and their means of support through the wall or floor openings to prevent the spread of fire. [5000, 2018]

**3.3.39 Fuel Load.** The total quantity of combustible contents of a building, space, or fire area, including interior finish and trim, expressed in heat units or the equivalent weight in wood. [921, 2017]

**3.3.40 Goal.** A nonspecific overall outcome to be achieved that is measured on a qualitative basis. [101, 2018]

**3.3.41 Governing Body.** The board of directors, trustees, owner, or other body charged with governance and fiduciary responsibility of a cultural resource property.

**3.3.42\* Hazardous Area.** An area of a structure or building that poses a degree of hazard greater than that normal to the general occupancy of the building or structure. [5000, 2018]

**3.3.43\* Historic Building.** For the purpose of this code, a building that is designated, or deemed eligible for such designation, by a local, regional, or national jurisdiction as having historical, architectural, or cultural significance.

**3.3.44 Historic Character.** The sum of all visual aspects, features, materials, and spaces associated with a cultural landscape history (i.e., the original configuration together with losses and later changes). These qualities are often referred to as *character defining*.

**3.3.45 Historic District.** A geographical area or theme which possesses a significant concentration, linkage or continuity of sites, buildings, structures, or objects united historically or aesthetically by plan or physical development.

**3.3.46 Historic Fabric.** Original or added building or construction materials, features, and finishes that existed during the period that is deemed to be most architecturally or historically significant, or both.

**3.3.47 Historic Integrity.** The authenticity of a property's historic identity, evidenced by the survival of physical characteristics that existed during the property's historic or prehistoric period.

**3.3.48 Historic Preservation.** A generic term that encompasses all aspects of the professional and public concern related to the maintenance of a historic structure, site, or element in its current condition, as originally constructed, or with the additions and alterations determined to have acquired significance over time.

**3.3.49 Historic Site.** A place, often with associated structures, having historic significance.

**3.3.50 Historic Structure.** A building, bridge, lighthouse, monument, pier, vessel, or other construction that is designa-

ted or that is deemed eligible for such designation by a local, regional, or national jurisdiction as having historical, architectural, or cultural significance.

**3.3.51 Hot Work.** Work involving burning, welding, or a similar operation that is capable of initiating fires or explosions. [51B, 2019]

**3.3.52 Impairment.** A condition where a fire protection system or unit, or portion thereof, is out of order, and the condition can result in the fire protection system or unit not functioning in a fire event. [25, 2017]

**3.3.52.1 Emergency Impairment.** A condition where a water-based fire protection system or portion thereof is out of order due to an unplanned occurrence, or the impairment is found while performing inspection testing or maintenance activities. [25, 2017]

**3.3.52.2 Preplanned Impairment.** As used in this code, a condition where a fire protection system or a portion thereof is out of service due to work that has been planned.

**3.3.53 Incapacitation.** A condition under which humans do not function adequately and become unable to escape untenable conditions. [101, 2018]

**3.3.54 Initiating Device.** A system component that originates transmission of a change-of-state condition, such as in a smoke detector, manual fire alarm box, or supervisory switch. [72, 2019]

**3.3.55 Input Data Specification.** Information required by the verification method. [101, 2018]

**■ 3.3.56 Integrated System.** A combination of systems that operate together as a whole to achieve the fire protection and life safety objectives. [3, 2018]

**3.3.57 Library.** Any building or place in which books and other media are kept for reading, reference, research, or lending.

**3.3.58\* Limited-Combustible Material.** See 4.5.2.

**3.3.59 Means of Egress.** A continuous and unobstructed way of travel from any point in a building or structure to a public way consisting of three separate and distinct parts: (1) the exit access, (2) the exit, and (3) the exit discharge. [101, 2018]

**3.3.60 Means of Escape.** A way out of a building or structure that does not conform to the strict definition of means of egress but does provide an alternate way out. [101, 2018]

**3.3.61 Museum.** An institution that acquires, conserves, researches, communicates, and exhibits material evidence of people and their environment for purposes of study, education, and enjoyment.

**3.3.62 Noncombustible.** See 4.5.1.

**3.3.63 Notification Appliance.** A fire alarm system component such as a bell, horn, loudspeaker, visual notification appliance, or text display that provides audible, tactile, or visual outputs, or any combination thereof. [72, 2019]

**3.3.64\* Objective.** A requirement that needs to be met to achieve a goal. [101, 2018]

- △ 3.3.65 Occupancy.** The purpose for which a building or other structure, or part thereof, is used or intended to be used. [ASCE/SEI 7:1.2.1]
- 3.3.66 Occupant Characteristics.** The abilities or behaviors of people before and during a fire. [101, 2018]
- 3.3.67 Occupant Load.** The total number of persons that might occupy a building or portion thereof at any one time. [101, 2018]
- 3.3.68\* Performance-Based Design Approach.** A design process whose fire safety solutions are designed to achieve a specified goal for a specified use or application.
- 3.3.69 Performance Criteria.** Threshold values on measurement scales that are based on quantified performance objectives. [101, 2018]
- △ 3.3.70 Perimeter Protection.** A scheme of protection that uses devices to detect or deter intrusion into a protected area. [730, 2018]
- 3.3.71 Place of Worship.** Any building that functions primarily as a group meeting place for the practice of religion, which includes, but is not limited to, churches, synagogues, cathedrals, temples, mosques and meeting halls.
- 3.3.72 Plenum.** A compartment or chamber to which one or more air ducts are connected and that forms part of the air distribution system. [90A, 2018]
- 3.3.73 Preservation.** The act or process of applying measures necessary to sustain the existing form, integrity, and materials of a historic building or structure.
- 3.3.74 Private.** Intended for or limited to the use of some particular person(s) or group.
- 3.3.75 Project Team.** A group of stakeholders including, but not limited to, representatives of architects, clients, engineers and designers, authorities having jurisdiction, and preservation specialists.
- 3.3.76\* Proposed Design.** A design developed by a design team and submitted to the authority having jurisdiction for approval. [101, 2018]
- 3.3.77 Protected Premises.** The physical location protected by a fire alarm system, fire suppression system, electronic premises protection system, or other type of protection system.
- 3.3.78\* Protection.** Features, systems, and programs implemented to prevent or minimize loss from fire, arson, vandalism, theft, natural disasters, disruptive events, and similar hazards to property collections or operations.
- 3.3.79 Protective Systems.** Automatic sprinklers, standpipes, carbon dioxide systems, clean agent systems, automatic covers, and other devices used for extinguishing fires.
- 3.3.80 Public.** Of, pertaining to, or affecting a population or a community as a whole; open to all persons.
- 3.3.81 Rehabilitation.** For the purpose of this code, the act or process of making possible a compatible use of a property through repair, alteration, and additions, while preserving those portions or features that convey its historic, cultural, or architectural value.
- N 3.3.82\* Resiliency.** The ability to adapt and recover from adverse or catastrophic events.
- 3.3.83 Restoration.** The act or process of accurately depicting the form, features, and character of a property as it appeared at a particular period of time by means of the removal of features from other periods of its history, reconstruction of missing features from the restoration period, and repair of damaged or altered features from the restoration period.
- 3.3.84 Safety Factor.** A factor applied to a predicted value to ensure that a sufficient safety margin is maintained. [101, 2018]
- 3.3.85 Safety Margin.** The difference between a predicted value and the actual value where a fault condition is expected. [101, 2018]
- 3.3.86 Scenario.**
- 3.3.86.1 Design Fire Scenario.** A fire scenario selected for evaluation of a proposed design. [101, 2018]
- 3.3.86.2\* Fire Scenario.** For the purposes of this code, a set of conditions that defines the development of fire, the spread of combustion products throughout a building or portion of a building, the reactions of people to fire, the impact of a fire on the historic significance in or near a room of particular significance, and the effects of combustion products.
- 3.3.87 Security Vulnerability Assessment (SVA).** A systematic and methodical process for examining ways an adversary might exploit an organization's security vulnerabilities to produce an undesired outcome. [730, 2018]
- 3.3.88 Self-Closing.** Equipped with an approved device that ensures closing after opening. [101, 2018]
- 3.3.89 Sensitivity Analysis.** An analysis performed to determine the degree to which a predicted output will vary given a specified change in an input parameter, usually in relation to models. [101, 2018]
- 3.3.90 Separation.** See 3.3.7.1, Fire Barrier.
- 3.3.91 Smoke Detector.** A device that detects visible or invisible particles of combustion. [72, 2019]
- 3.3.92\* Special Event.** Any activity outside of the normal daily operations.
- 3.3.93 Stakeholder.** An individual, or representative of same, having an interest in the successful completion of a project. [101, 2018]
- 3.3.94 System.**
- 3.3.94.1 Fire Alarm System.** A system or portion of a combination system that consists of components and circuits arranged to monitor and annunciate the status of fire alarm or supervisory signal-initiating devices and to initiate the appropriate response to those signals. [72, 2019]
- 3.3.94.2 Fire Protection System.** Any fire alarm device or system or fire-extinguishing device or system, or combination thereof, that is designed and installed for detecting, controlling, or extinguishing a fire or otherwise alerting occupants, or the fire department, or both, that a fire has occurred. [1141, 2017]

△ **3.3.94.3\* Sprinkler System.** A system, commonly activated by heat from a fire and discharges water over the fire area, that consists of an integrated network of piping designed in accordance with fire protection engineering standards that includes a water supply source, a water control valve, a waterflow alarm, and a drain. The portion of the sprinkler system above ground is a network of specifically sized or hydraulically designed piping installed in a building, structure, or area, generally overhead, and to which sprinklers are attached in a systematic pattern. [13, 2019]

**3.3.95 Uncertainty Analysis.** An analysis performed to determine the degree to which a predicted value will vary. [101, 2018]

**3.3.96 Verification Method.** A procedure or process used to demonstrate or confirm that the proposed design meets the specified criteria. [101, 2018]

**3.3.97 Vertical Opening.** An opening through a floor or roof. [101, 2018]

**3.3.98 Zone.** A defined area within the protected premises. A zone can define an area from which a signal can be received, an area to which a signal can be sent, or an area in which a form of control can be executed. [72, 2019]

## Chapter 4 General

**4.1 Goals and Objectives.** Goals and objectives shall be adopted that reflect the tolerance for risk that is acceptable to those responsible for the historic structure and historic district.

### 4.2 Goals.

**4.2.1** The goals of this code shall be to provide protection against vulnerabilities to hazards for historic structures or historic districts and their occupants while protecting those elements, spaces, and features that make the structures historically or architecturally significant and allow for continuity of operations.

**4.2.2** The goals shall be accomplished by operational approaches, system approaches, or the consideration of other factors, and shall include all of the following:

- (1) To provide reasonable safeguards for protection of property and the preservation of historic finishes, spaces, and architectural elements from the damaging effects of fire and security vulnerabilities
- (2) To provide for the protection and life safety of occupants not intimate with the initial fire development and improve the survivability of occupants intimate with the initial fire development
- (3) To provide an environment that is reasonably safe from security threats for the occupants inside or near a building
- (4) To maintain the historic fabric and integrity of the building
- (5) To provide for continuity of operations

### 4.3\* Objectives.

#### 4.3.1 Life Safety.

**4.3.1.1** An egress system shall be designed, implemented, and maintained to protect the occupants not intimate with the initial fire development for the time needed to evacuate, relocate, or defend in place.

**4.3.1.2** Structural integrity during a fire shall be maintained for the time needed to evacuate, relocate, or defend in place the occupants not intimate with the initial fire development.

**4.3.1.3** Building construction and operation necessary to achieve the goals of this code shall be effective, maintained, and operational.

**4.3.1.4** Security measures shall be designed, implemented, and maintained to achieve the goals of this code.

#### 4.3.2 Historic Preservation.

**4.3.2.1\*** Fire safety, fire protection features, and security measures shall be designed, approved, implemented, and maintained to preserve the original qualities or character of a building, structure, site, or environment.

**4.3.2.2** Removal or alteration of any historic material or distinctive architectural features for the purpose of improving fire protection, security, or life safety shall be minimized.

**4.3.2.3** Distinctive stylistic features or examples of skilled craftsmanship that characterize a building, structure, or site shall be treated with sensitivity.

**4.3.2.4\*** A compatible use for a property that requires minimal alteration of the building, structure, or site and its environment shall be encouraged.

**4.3.2.5** New additions or alterations shall be designed and constructed in such a manner that, if such additions or alterations were to be removed in the future, the essential form and integrity of the structure would be, to the greatest degree possible, unimpaired.

### 4.4 Compliance Options.

**4.4.1 General.** Building design, fire protection and security features, and programs shall meet the life safety and property conservation goals and objectives of Chapter 4, in accordance with one of the following:

- (1) Prescriptive-based provisions of 4.4.2
- (2) Performance-based provisions of 4.4.3
- (3) A combination of prescriptive- and performance-based provisions found acceptable to the authority having jurisdiction

**4.4.2 Prescriptive-Based Option.** A prescriptive-based design shall be in accordance with Chapters 1 through 8 and Chapters 11 through 16 of this code.

**4.4.3 Performance-Based Option.** A performance-based design shall be in accordance with Chapters 1 through 7 and Chapters 9, 11, 14, and 15 of this code.

△ **4.4.4 Management Operational Systems.** Management operational systems complying with Chapter 10 of this code shall be permitted as an element of a prescriptive- or performance-based solution.

### 4.5 Materials.

#### 4.5.1 Noncombustible Material.

**4.5.1.1** A material that complies with any one of the following shall be considered a noncombustible material:

- (1) The material, in the form in which it is used, and under the conditions anticipated, will not ignite, burn, support

combustion, or release flammable vapors when subjected to fire or heat.

- (2) The material is reported as passing ASTM E136, *Standard Test Method for Behavior of Materials in a Vertical Tube Furnace at 750°C*.
- (3) The material is reported as complying with the pass/fail criteria of ASTM E136 when tested in accordance with the test method and procedure in ASTM E2652, *Standard Test Method for Behavior of Materials in a Tube Furnace with a Cone-shaped Airflow Stabilizer, at 750°C*.

[5000:7.1.4.1.1]

**4.5.1.2** Where the term *limited-combustible* is used in this code, it shall also include the term *noncombustible*. [5000:7.1.4.1.2]

**Δ 4.5.2 Limited-Combustible Material.** A material shall be considered a limited-combustible material where all the conditions of 4.5.2(1) and 4.5.2(2), and the conditions of either 4.5.2.1 or 4.5.2.2, are met:

- (1) The material does not comply with the requirements for a noncombustible material in accordance with 4.5.1.
- (2) The material, in the form in which it is used, exhibits a potential heat value not exceeding 3500 Btu/lb (8141 kJ/kg), when tested in accordance with NFPA 259.

[5000:7.1.4.2]

**4.5.2.1** The material shall have the structural base of noncombustible material with a surfacing not exceeding a thickness of 1/8 in. (3.2 mm) where the surfacing exhibits a flame spread index not greater than 50 when tested in accordance with ASTM E84, *Standard Test Method for Surface Burning Characteristics of Building Materials*, or ANSI/UL 723, *Standard for Test for Surface Burning Characteristics of Building Materials*. [5000:7.1.4.2.1]

**4.5.2.2** The material shall be composed of materials that in the form and thickness used, neither exhibit a flame spread index greater than 25 nor evidence of continued progressive combustion when tested in accordance with ASTM E84 or ANSI/UL 723 and are of such composition that all surfaces that would be exposed by cutting through the material on any plane would neither exhibit a flame spread index greater than 25 nor exhibit evidence of continued progressive combustion when tested in accordance with ASTM E84 or ANSI/UL 723. [5000:7.1.4.2.2]

**N 4.5.2.3** Materials shall be considered limited-combustible materials where tested in accordance with ASTM E2965, *Standard Test Method for Determination of Low Levels of Heat Release Rate for Materials and Products Using an Oxygen Consumption Calorimeter*, at an incident heat flux of 75 kW/m<sup>2</sup> for a 20-minute exposure, and both the following conditions are met:

- (1) The peak heat release rate shall not exceed 150 kW/m<sup>2</sup> for longer than 10 seconds.
- (2) The total heat released shall not exceed 8 MJ/m<sup>2</sup>.

[5000:7.1.4.2.3]

**4.5.2.4** Where the term *limited-combustible* is used in this code, it shall also include the term *noncombustible*. [5000:7.1.4.2.4]

## Chapter 5 Reserved

## Chapter 6 Reserved

## Chapter 7 Process

**7.1\* General.** The process by which this code shall be applied is shown in Figure 7.1.

### 7.2\* Project Team.

**7.2.1** The owner or governing body shall identify a project team to oversee the application of the code to the historic building or historic district.

**7.2.2** The team shall include persons with expertise in historic preservation, fire protection, and security.

**7.3\* Assessment.** A detailed assessment or survey of the fire safety features and the historic integrity of the structure, site, or both, shall be completed.

### 7.3.1\* Identification of Historic Elements, Spaces, and Features.

#### 7.3.1.1 Historic Documentation.

**7.3.1.1.1** All persons involved with the design of the building shall be aware of the cultural significance of the historic structure or historic district prior to beginning the design.

**7.3.1.1.2** All persons involved with the construction process shall be thoroughly briefed on the cultural significance and importance of the structure, spaces, or character-defining features prior to the beginning of the work.

**7.3.1.2\* Historic Structure: Exterior.** The building survey shall identify those character-defining features and finishes that make the exterior of the building significant.

**7.3.1.3\* Construction.** The building survey shall determine primary and secondary significance of all character-defining features and facades.

**7.3.1.4 Adjacent and Secondary Structures.** The building survey shall include all structures located on or adjacent to the historic property.

**7.3.1.5 Site Elements.** The building survey shall identify significant character-defining features of the property such as vegetation, landscape features, roads and driveways, walking paths, fencing, and exterior use.

**7.3.1.6\* Historic Structure: Interior.** The building survey shall identify all significant interior spaces, floor plan organization, and character-defining features and finishes in the building, including those original to the building and those changes that have acquired significance in their own right.

**7.3.2\* Prioritization of Historic Elements, Spaces, and Features.** The building survey shall determine relative significance of all historic elements, spaces, and features.



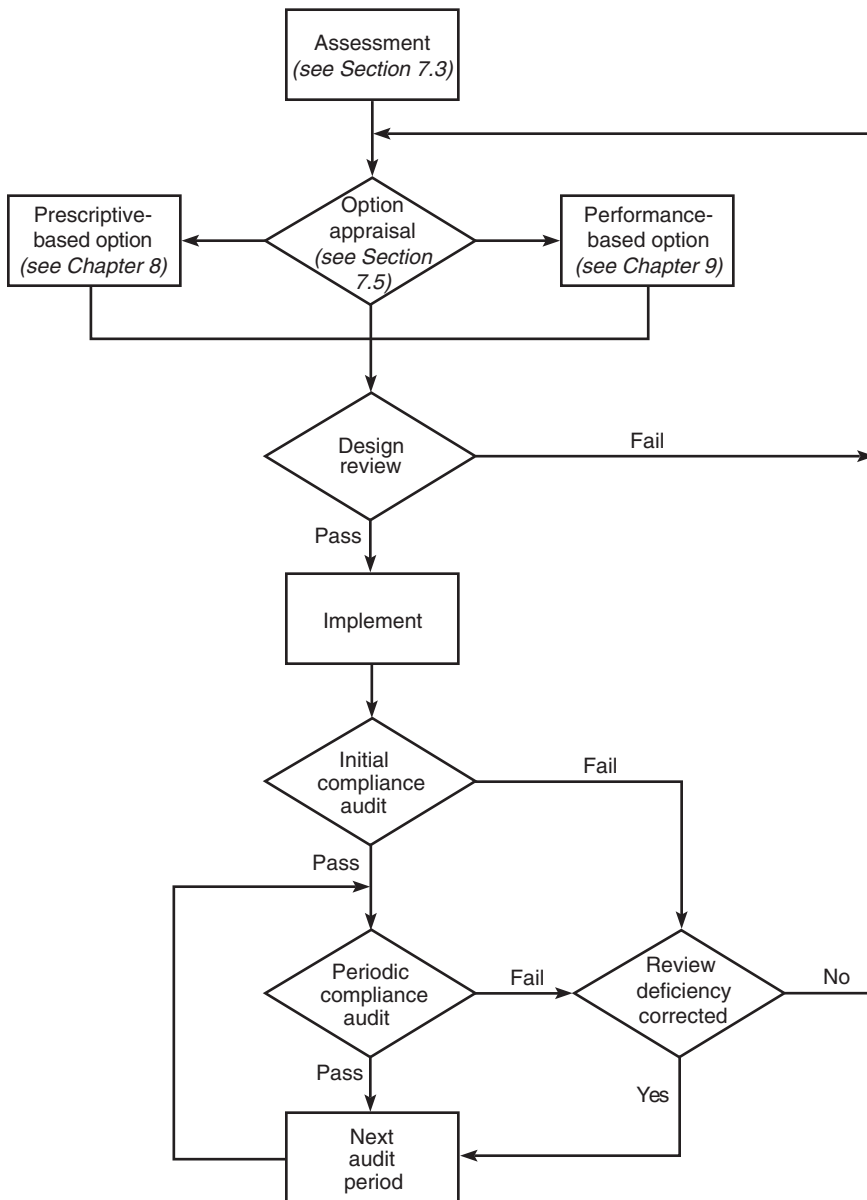

▲ FIGURE 7.1 Process Flow Chart.

### 7.3.3 Identification of Fire Safety Issues.

#### 7.3.3.1 Code, Standard, and Regulation Compliance.

7.3.3.1.1 The building survey of existing conditions shall include a review of all fire safety-related requirements to determine if and where the historic building or historic district is deficient with respect to applicable codes.

7.3.3.1.2 Alternative methods that offer equivalent or greater protection while preserving the character-defining spaces, features, and finishes of the historic structure shall be permitted.

7.3.3.1.3\* Buildings shall be evaluated in accordance with the requirements of the applicable building and fire codes.

7.3.3.2 **Fire Hazards and Safety Deficiencies.** The building survey shall identify known conditions that contribute to the start or spread of a fire or to the endangerment of people or property by fire.

7.3.3.3 **Fire Spread.** The building shall be evaluated to determine known potential paths of fire spread, both internal and external, that are inherent to its design.

7.3.3.4\* **Means of Egress.** An evaluation of the means of egress shall be completed that includes, but is not limited to, numbers of means of egress, means of egress capacity, exit enclosure fire resistance, dead-end corridors, travel distances to exits, and unenclosed stairs in accordance with applicable codes.

### 7.3.4 Prioritization of Fire Safety Issues.

**7.3.4.1\*** The building survey shall determine the relative importance of identified fire safety issues.

**7.3.4.2\*** Where approved by the authority having jurisdiction, historic buildings that are acceptable using a fire risk indexing method shall be considered to be in compliance with applicable fire safety codes.

### 7.4 Options.

**7.4.1** Structures that are found to satisfy both the life safety and historic preservation objectives of this code shall be subject to the periodic compliance audit required by Section 7.9.

**7.4.2** Structures that are found to have life safety deficiencies, preservation needs, or both, shall have a plan of correction developed that satisfies one of the following:

- (1) Prescriptive compliance, including equivalency, alternatives, and modifications
- (2) Risk indexing compliance
- (3) Performance-based compliance
- (4) Any combination of items 7.4.2(1) through 7.4.2(3)

### 7.5 Option Appraisal and Selection.

#### 7.5.1\* Selection Criteria.

**7.5.1.1** An appraisal of the available options shall be made by the project team and a method of application of the code shall be selected.

**7.5.1.2** The method of application shall be the prescriptive-based approach, the performance-based approach, or a combination of both.

**Δ 7.5.2 Prescriptive-Based Option.** Prescriptive solutions shall meet the requirements of Chapters 1 through 8 and Chapters 11 through 16, including any exceptions contained within the referenced prescriptive codes and standards.

**Δ 7.5.3 Performance-Based Option.** Performance-based solutions shall be developed in accordance with Chapters 1 through 7 and Chapters 9, 11, 14, and 15 of this code.

**7.6 Design Review.** The project team shall review and approve the preferred design approach to achieve compliance.

**7.7 Initial Compliance Audit.** Upon completion of the implementation phase, there shall be an initial compliance audit by the project team to ensure compliance with the selected design approach.

**7.8 Approval.** The AHJ shall make the final determination as to whether compliance has been achieved.

### 7.9 Periodic Compliance Audit.

**7.9.1** The periodic compliance audit shall be conducted by the AHJ at intervals identified in the approved fire safety management plan, but not less than annually.

**7.9.2** Additional compliance audits shall be conducted prior to special events (*see Chapter 16*).

#### 7.9.3 Exit Interview.

**7.9.3.1** The AHJ shall conduct an exit interview with the fire safety manager and the owner or governing body of the building upon completion of the periodic compliance audit.

**7.9.3.2** The exit interview shall identify all areas of noncompliance with the approved management plan.

**7.9.3.3** Following the periodic compliance audit, any deficiencies shall be addressed, with corrective action taken and documented.

## Chapter 8 Prescriptive-Based Approach

### 8.1 General.

#### 8.1.1\* Application.

**8.1.1.1** Prescriptive requirements of the applicable codes shall be applied with the intent of achieving the goals and objectives of Chapter 4 of this document.

**8.1.1.2\*** Application of prescriptive requirements shall include alternatives, equivalencies, modifications, or any combination thereof.

**8.1.2\* Alternatives.** Prescribed alternative methods of compliance in the applicable codes shall be identified.

#### 8.1.3\* Equivalency.

**8.1.3.1** The AHJ shall approve other fire safety approaches, systems, methods, or devices that are equivalent or superior to those prescribed by this code, provided that adequate documentation is submitted to demonstrate equivalency.

**8.1.3.2\*** Approaches, systems, methods, or devices approved as equivalent by the AHJ shall be recognized as being in compliance with this document.

#### 8.1.4\* Modification of Requirements.

**8.1.4.1** The requirements of the applicable codes shall be permitted to be modified if their application clearly would be impractical in the judgment of the AHJ, but only where it is also clearly evident that a reasonable degree of safety is provided.

**8.1.4.2** The modifications that are allowed and any additional requirements that are imposed as a result shall be documented.

**8.2\* Compensatory Features.** Where equivalencies or modifications of requirements are proposed, the following fire safety features shall be permitted to be considered as compensatory features:

- (1) Noncombustible or limited-combustible construction materials
- (2) Noncombustible or fire-retardant treatments for new interior finish materials and historic fabrics
- (3) Noncombustible or fire-retardant-treated materials for furnishings and contents
- (4) Walls and doors that will prevent the horizontal spread of fire and smoke, to subdivide building areas or to segregate specific hazards such as boilers, furnaces, or storage areas from the remainder of the building
- (5) Enclosure of stairways, ventilation shafts, and other vertical openings with construction to prevent the vertical spread of fire and smoke
- (6)\* Firestops to prevent the spread of fire within walls and between rafters and joists and through horizontal and vertical fire
- (7)\* Fire-resistive construction

- (8)\* Fire detection and alarm systems that will sound an alarm within the structure and transmit an alarm signal to an alarm monitoring location or local fire department
- (9) Automatic suppression systems, manual suppression systems, or a combination of the two
- (10) Management and operational controls that meet the requirements of Chapter 10
- (11) Installation of arc-fault circuit-interrupters (AFCIs)
- (12) Height of ceilings, with recognition that a large volume of space above head height provides occupants at floor level additional time to safely exit the room or building

## Chapter 9 Performance-Based Approach

### 9.1\* General.

**9.1.1 Application.** The requirements of this chapter shall apply to fire protection systems, management operation systems, and life safety systems designed according to the performance-based option permitted by 7.5.3.

**9.1.2 Goals and Objectives.** The performance-based design shall meet the goals and objectives of this code in accordance with Sections 4.2 and 4.3.

**9.1.3\* Approved Qualifications.** The performance-based design shall be prepared by a person with qualifications acceptable to the AHJ. (See also 9.8.12.)

**9.1.4\* Independent Review.** The AHJ shall be permitted to require review and evaluation by an approved, independent third party.

### 9.1.5 Sources of Data.

**9.1.5.1** The source for each input data requirement that must be met by using a data source other than a design fire scenario, an assumption, or a building design specification shall be identified and documented.

**9.1.5.2** Sources of data shall be characterized as to the degree of conservatism reflected, and a justification for the source shall be provided.

**9.1.6 Final Determination.** The AHJ shall make the final determination as to whether the performance objectives have been met.

### 9.1.7\* Maintenance of Design Features.

**9.1.7.1** The design features and management operational system required for the building or historic district to continue to meet the performance goals and objectives of this code shall be maintained for the life of the building or historic district.

**9.1.7.2** This management operational system shall include complying with all documented assumptions and design specifications.

**9.1.7.3** Any variations to the management operational system shall require the approval of the AHJ prior to the actual change. (See also 7.9.1.)

**9.1.8 Special Definitions.** A list of special terms used in this chapter is as follows:

- (1) **Design Fire Scenario.** See 3.3.86.1.
- (2) **Design Specification.** See 3.3.20.
- (3) **Design Team.** See 3.3.21.
- (4) **Exposure Fire.** See 3.3.27.

- (5) **Fire Model.** See 3.3.32.
- (6) **Fire Scenario.** See 3.3.86.2.
- (7) **Fuel Load.** See 3.3.39.
- (8) **Incapacitation.** See 3.3.53.
- (9) **Input Data Specification.** See 3.3.55.
- (10) **Occupant Characteristics.** See 3.3.66.
- (11) **Performance Criteria.** See 3.3.69.
- (12) **Proposed Design.** See 3.3.76.
- (13) **Safety Factor.** See 3.3.84.
- (14) **Safety Margin.** See 3.3.85.
- (15) **Sensitivity Analysis.** See 3.3.89.
- (16) **Stakeholder.** See 3.3.93.
- (17) **Uncertainty Analysis.** See 3.3.95.
- (18) **Verification Method.** See 3.3.96.

### 9.2 Performance Criteria.

#### 9.2.1 General.

**9.2.1.1** An historic structure or district shall meet the performance criteria for life safety and historic preservation.

**9.2.1.2** Each design shall meet the objectives specified in Section 4.3, if, for each design fire scenario, assumption, and design specification, the performance criteria in 9.2.2 are met.

#### 9.2.2 Performance Criteria.

**9.2.2.1\* Life Safety Performance Criteria.** Any occupant who is not intimate with ignition shall not be exposed to instantaneous or cumulative untenable conditions.

**9.2.2.2\* Historic Preservation Performance Criteria.** Historically significant rooms, spaces, or contents shall not be exposed to instantaneous or cumulative fire effects that cause irreversible damage.

### 9.3 Retained Prescriptive Requirements.

**9.3.1\* Systems and Features.** All fire protection systems and features of the building shall comply with applicable NFPA standards for those systems and features.

**9.3.2\* Means of Egress.** Features of the means of egress not specifically addressed in the performance criteria shall comply with NFPA 101.

### 9.4 Design Specifications and Other Conditions.

**9.4.1\* Clear Statement.** Design specifications and other conditions used in the performance-based design shall be demonstrated to the AHJ to be realistic and sustainable.

#### 9.4.2 Assumptions and Design Specifications Data.

**9.4.2.1** Each assumption and design specification used in the design shall be accurately translated into input data specifications as appropriate for the calculation method or model.

**9.4.2.2** Any assumptions and design specifications that the design analyses do not explicitly address or incorporate and are, therefore, omitted from input data specifications shall be identified, and a sensitivity analysis of the consequences of that omission shall be performed.

**9.4.2.3** Any assumptions and design specifications that are modified in input data specifications because of limitations in test methods or other data generation procedures shall be identified, and a sensitivity analysis of the consequences of the modification shall be performed.

**9.4.3\* Building Characteristics.** Characteristics of the building or its contents, equipment, or operations that are not inherent in the design specifications but affect occupant behavior or the rate of hazard development shall be explicitly identified.

**9.4.4\* Operational Status and Effectiveness of Building Features and Systems.** The performance of fire protection systems and building features shall reflect the documented performance of the components of those systems or features unless design specifications are incorporated to modify the expected performance.

#### 9.4.5 Occupant Characteristics.

##### 9.4.5.1 General.

**9.4.5.1.1\*** The selection of occupant characteristics to be used in the design calculations shall be approved by the AHJ and shall provide an accurate reflection of the expected population of building occupants.

**9.4.5.1.2** Occupant characteristics shall not vary across fire scenarios except as authorized by the AHJ.

**9.4.5.2\* Response Characteristics.** Each of the following basic performance response characteristics shall be considered:

- (1) Sensibility
- (2) Reactivity
- (3) Mobility
- (4) Susceptibility

**9.4.5.2.1** These estimations shall reflect the expected distribution of characteristics of a population appropriate to the use of the building.

**9.4.5.2.2** The source of data for these characteristics shall be documented.

**9.4.5.3 Location.** The assumption shall be made that in every normally occupied room or area, at least one person shall be located at the most remote point from the exits.

##### 9.4.5.4\* Number.

**9.4.5.4.1** The design shall be based on the maximum number of people that every occupied room or area is expected to contain.

**9.4.5.4.2** Where success or failure of the design is contingent on a maximum number of occupants, operational controls shall be used.

**9.4.5.5\* Staff Assistance.** The ability of trained employees to be included as part of the fire safety system shall be identified, and the necessary training and capabilities shall be documented.

**9.4.6 Emergency Response Personnel.** Design characteristics or other conditions related to the availability, speed of response, effectiveness, roles, and other characteristics of emergency response personnel shall be specified or characterized sufficiently for evaluation of the design.

**9.4.7\* Post-Construction Conditions.** Design characteristics or other conditions related to activities during the life of the building that affect the ability of the building to meet the stated goals and objectives shall be specified, estimated, or characterized sufficiently to evaluate the design.

**9.4.8 Off-Site Conditions.** Design characteristics or other conditions related to resources or conditions outside the property being designed that affect the ability of the building to meet the stated goals and objectives shall be specified, estimated, or characterized sufficiently to evaluate the design.

**9.4.9\* Consistency of Assumptions.** The design shall not include mutually inconsistent assumptions, specifications, or statements of conditions.

**9.4.10\* Special Provisions.** Additional provisions not covered by Section 9.4 but that are required for the design to comply with the performance objectives shall be documented.

#### 9.5 Design Fire Scenarios.

##### 9.5.1\* General.

**9.5.1.1** The AHJ shall approve the parameters involved with design fire scenarios.

**9.5.1.2** The proposed design shall meet the goals and objectives if it achieves the performance criteria for each required design fire scenario. (*See 9.5.3.*)

##### 9.5.2\* Evaluation.

**9.5.2.1** Design fire scenarios shall be evaluated using a method acceptable to the AHJ and appropriate for the conditions.

**9.5.2.2** Each scenario shall be challenging but realistic with respect to at least one of the following scenario specifications:

- (1) Initial fire location
- (2) Early rate of growth in fire severity
- (3) Smoke generation

**9.5.2.3** The scenario specifications shall be as challenging as could realistically occur in the building.

##### 9.5.3\* Required Design Fire Scenarios.

**9.5.3.1** Scenarios selected as design fire scenarios shall include, but not be limited to, those specified in 9.5.3.2 through 9.5.3.9.

**9.5.3.1.1** Each scenario shall include a life safety aspect (Part A) and a building protection aspect (Part B), when applicable.

**9.5.3.1.2** Design fire scenarios demonstrated by the design team to the satisfaction of the AHJ as inappropriate for the building use and conditions shall not be required.

**9.5.3.2\* Design Fire Scenario 1.** This scenario shall be an occupancy-specific design fire scenario that is representative of a typical fire for the occupancy.

**9.5.3.2.1** This scenario shall explicitly account for the following:

- (1) Occupant activities, number, and location
- (2) Room size
- (3) Nature and significance of furnishings and contents
- (4) Fuel properties and ignition sources
- (5) Ventilation conditions

**9.5.3.2.2** The first item ignited and its location shall be explicitly defined.

**9.5.3.3\* Design Fire Scenario 2.** This scenario shall be an ultrafast-developing fire in the primary means of egress, with interior doors open at the start of the fire.

**9.5.3.3.1 Part A.** This design fire scenario shall address reducing the number of available means of egress.

**9.5.3.3.2 Part B.** This design fire scenario shall address reducing the effects of a rapidly spreading fire on interior finish and structural components.

**9.5.3.4\* Design Fire Scenario 3.** This scenario shall be a fire, starting in a normally unoccupied room, that potentially can endanger a large number of occupants in a large room or other area.

**9.5.3.4.1 Part A.** This design fire scenario shall address a fire that starts in a normally unoccupied room and migrates into the space that potentially can hold the greatest number of occupants in the building.

**9.5.3.4.2 Part B.** This design fire scenario shall address a fire that starts in an unoccupied space, that potentially can grow and endanger the area of greatest historical significance.

**9.5.3.5\* Design Fire Scenario 4.** This scenario shall be a fire that originates in a concealed wall or ceiling space that is adjacent to a large number of occupants in a large room.

**9.5.3.5.1 Part A.** This design fire scenario shall address the concern of a fire that originates in a concealed space that does not have either a detection system or suppression system, and that spreads into the room within the building that potentially can hold the greatest number of occupants.

**9.5.3.5.2 Part B.** This design fire scenario shall address a fire that originates in a concealed space that does not have either a detection system or a suppression system, that potentially can grow and endanger the area of greatest historical significance.

**9.5.3.6\* Design Fire Scenario 5.** This scenario shall be a slow-developing fire that is shielded from fire protection systems and is in close proximity to a high-occupancy area.

**9.5.3.6.1 Part A.** This design fire scenario shall address a relatively small ignition source that causes a significant fire.

**9.5.3.6.2 Part B.** This design fire scenario shall address a relatively small ignition source that causes a significant fire that can potentially endanger the area of greatest historical significance as the result of the delayed suppression of the fire.

**9.5.3.7\* Design Fire Scenario 6.**

**9.5.3.7.1** This scenario shall be the most severe fire that results from the largest possible fuel load that is characteristic of the normal operation of the building.

**9.5.3.7.2** This scenario shall address the concern of a rapidly developing fire with occupants present.

**9.5.3.8\* Design Fire Scenario 7.**

**9.5.3.8.1** This scenario shall be an outside exposure fire.

**9.5.3.8.2** This scenario shall address a fire that starts remotely from the area of concern and either spreads into the area, blocks escape from the area, or develops untenable conditions within the area.

**9.5.3.9\* Design Fire Scenario 8.** This scenario shall be a fire that originates in ordinary combustibles in a room or area with

each passive or active fire protection system rendered unavailable one by one.

**9.5.3.9.1** This set of design fire scenarios shall address each fire protection system or fire protection feature, considered individually, being unreliable or unavailable.

**9.5.3.9.2\*** Design Fire Scenario 8 shall not be required for fire protection systems where the level of reliability in conjunction with the design performance in the absence of the system is acceptable to the AHJ.

**9.5.4 Design Fire Scenario Data.**

**9.5.4.1** Each design fire scenario used in the performance-based design proposal shall be translated into input data specifications, as appropriate, for the calculation method or model.

**9.5.4.2** Any design fire scenario specifications that the design analyses do not explicitly address or incorporate, and are, therefore, omitted from input data specifications, shall be identified, and a sensitivity analysis of the consequences of that omission shall be performed.

**9.5.4.3** Any design fire scenario specifications modified in input data specifications because of limitations in test methods or other data generation procedures shall be identified, and a sensitivity analysis of the consequences of the modification shall be performed.

**9.6 Evaluation of Proposed Design.**

**9.6.1\* General.**

**9.6.1.1** A proposed design's performance shall be assessed relative to each performance objective in Section 4.3 and to each applicable scenario in Section 9.5, with the assessment conducted through the use of appropriate calculation methods.

**9.6.1.2** The AHJ shall approve the choice of assessment methods.

**9.6.2 Use.** The design professional shall use the assessment methods to demonstrate that the proposed design will achieve the goals and objectives as measured by the performance criteria, in light of the safety margins and uncertainty analysis, for each scenario, given the assumptions.

**9.6.3 Input Data.**

**9.6.3.1 Data.**

**9.6.3.1.1** Input data for computer fire models shall be obtained in accordance with ASTM E1591, *Standard Guide for Obtaining Data for Fire Growth Models*.

**9.6.3.1.2** Data for use in analytical models that are not computer-based fire models shall be obtained using appropriate measurement, recording, and storage techniques to ensure the applicability of the data to the analytical method being used.

**9.6.3.2 Data Requirements.** A complete listing of input data requirements for all models, engineering methods, and other calculation or verification methods that are required or proposed as part of the performance-based design shall be provided.

**9.6.3.3\* Uncertainty and Conservatism in Data.** Uncertainty in input data shall be analyzed and, as determined appropriate by the AHJ, addressed through the use of conservative values.

**9.6.4\* Output Data.** The assessment methods used shall accurately and appropriately produce the required output data from input data based on the design specifications, assumptions, and scenarios.

**9.6.5 Validity.** Evidence shall be provided confirming that the assessment methods are valid and appropriate for the proposed building, use, and conditions.

**9.7\* Safety Factors.** Approved safety factors shall be included in the design methods and calculations to reflect uncertainty in the assumptions, data, and other factors associated with the performance-based design.

## **9.8 Documentation Requirements.**

### **9.8.1\* General.**

**9.8.1.1** All aspects of the design, including those described in 9.8.2 through 9.8.13, shall be documented.

**9.8.1.2** The format and content of the documentation shall be acceptable to the AHJ.

### **9.8.2\* Technical References and Resources.**

**9.8.2.1** The AHJ shall be provided with sufficient documentation to support the validity, accuracy, relevance, and precision of the proposed assessment methods.

**9.8.2.2** The engineering standards, calculation methods, and other forms of scientific information provided shall be appropriate for the particular application and methodologies used.

**9.8.3 Building Design Specifications.** All details of the proposed building design that affect the ability of the building to meet the stated goals and objectives shall be documented.

**9.8.4 Performance Criteria.** Performance criteria, with sources, shall be documented.

**9.8.5 Occupant Characteristics.** Assumptions made about occupant characteristics shall be documented.

**9.8.6 Design Fire Scenarios.** Descriptions of design fire scenarios shall be documented.

**9.8.7 Input Data.** Input data to models and assessment methods, including a sensitivity analysis, shall be documented.

**9.8.8 Output Data.** Output data from models and assessment methods, including a sensitivity analysis, shall be documented.

**9.8.9 Safety Factors.** Safety factors utilized shall be documented.

**9.8.10 Prescriptive Requirements.** Retained prescriptive requirements shall be documented.

### **9.8.11\* Modeling Features.**

**9.8.11.1** Assumptions made by the model user and descriptions of models and methods used, including known limitations, shall be documented.

**9.8.11.2** Documentation shall be provided that indicates the validity and appropriateness of the assessment methods used to address the design specifications, assumptions, and scenarios.

**9.8.12 Evidence of Modeling Capability.** The design team's relevant experience with the models, test methods, databases, and other assessment methods used in the performance-based design proposal shall be documented.

**9.8.13 Use of Performance-Based Design Option.** Design proposals shall include documentation that provides anyone involved in ownership or management of the building with notification of the following:

- (1) The building was approved as a performance-based design with certain specified design criteria and assumptions.
- (2) Any remodeling, modification, renovation, change in use, or change in the established assumptions shall require a re-evaluation and re-approval.
- (3) All special events shall be reviewed and approved based upon the designs developed under this chapter.

**9.9 Records.** Records required in this section shall be maintained for the life of the current performance-based design.

**9.10\* Security Planning.** The governing body of a historic structure, or a designated representative, shall be responsible for security planning.

**9.10.1\*** Security planning shall include a security vulnerability assessment (SVA) that evaluates the historic structure's vulnerability to hazards and security risks, as well as the facility's overall preparedness and resiliency.

**9.10.2\*** The SVA shall evaluate all of the following:

- (1)\* Threats from vandalism
- (2) Threats from conditions that increase the risk of arson
- (3) Threats from acts of terrorism
- (4) Threats posed by construction, alteration, or renovation projects
- (5) Impact of security countermeasures on the historic character, integrity, and character-defining features of the historic structure and its cultural landscape

## **9.11 Security Plan.**

**9.11.1\*** The security plan shall include countermeasures satisfying the goals and objectives from Chapter 4 for the potential threats identified in the SVA.

**9.11.2\*** Security measures shall not compromise life safety requirements.

**9.11.3\*** Security measures shall be selected and designed to maintain the historic character, integrity, and character-defining features of the historic structure and its cultural landscape.

**9.11.4\*** The governing body of the historic structure shall review and revise the security plan when changes occur that affect the security of the property.

## **Chapter 10 Management Operational Systems**

### **10.1\* General.**

**10.1.1** Chapter 10 shall apply to historic buildings having on-site trained staff when the building is open to the general public or otherwise occupied.

**10.1.2** Chapter 10 shall establish criteria for management operational systems that are acceptable as elements of a

prescriptive solution or a performance-based approach, as provided in 4.4.4.

**10.1.3** Other operational control features shall be permitted subject to the approval of the AHJ.

**10.2\* Responsibility/Authority.**

**10.2.1\*** The governing body for the building and site shall designate a fire safety manager in accordance with 1.5.1.

**Δ 10.2.2** The fire safety manager shall be responsible for the implementation and maintenance of the management operational system, including, but not limited to, the following:

- (1) Directing the actions of building staff and occupants with regard to fire safety
- (2) Entering into legally binding contractual agreements with the AHJ
- (3) Ordering required fire safety drills and exercises
- (4) Halting contractor and maintenance operations that could threaten the fabric or contents of the building

**10.2.3** When a fire is deemed suspicious, the fire safety manager shall take steps to ensure that the fire is reported and the scene is secured pending investigation.

**10.3\* Management Plan.**

**10.3.1** The fire safety management plan shall consist of required elements, as set forth in 10.4 through 10.12, and optional elements as agreed to by the property manager and the AHJ.

**10.3.2** The fire safety management plan shall be approved by the AHJ.

**10.4 Operational Requirements.**

**Δ 10.4.1\*** Operational controls or a plan of operations shall be developed and include all special provisions defined by the project team and approved by the AHJ.

**10.4.2\*** Operational controls shall include the special provisions pertaining to the management, operations, and stewardship of the historic property.

**10.4.3\*** Operational controls shall be defined as part of the option appraisal.

**10.5 Fire Emergency Response Plan.**

**10.5.1** The fire safety manager and the owner or governing body shall develop and implement an emergency response plan, subject to the approval of the AHJ.

**10.5.2** The plan shall include provisions for notifying the fire department of the type and location of the emergency and directing them to the location when they arrive at the property.

**10.5.3** Emergency telephone numbers shall be posted on or adjacent to all telephones.

**10.5.4** An emergency evacuation plan shall be prepared in cooperation with the local fire department and other applicable authorities and updated annually.

**Δ 10.5.5** The emergency evacuation plan shall include the following:

- (1) Fire safety precautions for special events and celebrations when normal operational conditions that impact life safety are changed

- (2) Necessary adjustments to fire safety precautions for temporary and special exhibits
- (3) Modification of staff training and drills to adjust for circumstances and visitation created by special events and exhibits
- (4) Provisions to notify the local fire department of special events

**10.6 Training.**

**10.6.1** The fire safety manager shall develop an approved training plan.

**10.6.2** The fire safety manager, building staff, and volunteers shall receive training in accordance with the approved training plan specified in 10.6.1.

**N 10.6.3** Training shall include the fire emergency response plan, use of fire protection equipment, and other elements of the approved management plan.

**10.7 Drills.**

**10.7.1** Drills shall be conducted to reinforce training and evaluate staff and volunteer preparedness, at intervals agreed upon by the fire safety manager and the AHJ, but in no event less than annually.

**10.7.2** Where required, the AHJ shall be notified in advance of all scheduled drills.

**Δ 10.7.3** Additional training shall be required when any of the following conditions occurs:

- (1) Use, occupancy, structure, or internal layout of the building changes.
- (2)\* Drills indicate that staff or volunteers are not sufficiently familiar with the facility's fire safety management plan and fire protection equipment to respond properly under emergency conditions.
- (3) Special events having unusual occupancies or conditions are scheduled.
- (4) Portable fire extinguishers constitute a part of the fire safety management plan.
- (5)\* Introduction of new materials, substances, or products into the building.

**10.8 Record Keeping.**

**10.8.1** The fire safety manager shall be responsible for maintaining records for the fire safety management plan and management operational system.

**10.8.2** Records shall be made available to the AHJ on request.

**10.8.3** Records shall include the following:

- (1) Training of staff and volunteers, including fire evacuation drills and use of portable fire extinguishers
- (2) Inspection, testing, and maintenance reports for all fire safety equipment and systems, including records of actions taken to correct deficiencies
- (3) As-built plans, specifications, wiring and layout diagrams, and acceptance test reports for all fire protection systems including detection, alarm, and suppression systems
- (4) Fire emergency response plan
- (5) Inspection reports by local code enforcement officials, the AHJ, local fire service officials, and insurance loss control representatives, including records of action taken to correct deficiencies identified during each inspection

- (6) Fire protection system(s) activation and alarm reports, complete with the cause of the alarm or activation, the response, and the corrective action(s) taken
- (7) Full reports, including cause, extent of damage, response, and recovery of all fire incidents
- (8) Operational requirements as defined in the approved fire safety management plan
- (9) Additional records as required by the AHJ

### 10.9 Periodic Compliance Audit.

**10.9.1** The periodic compliance audit shall be conducted at intervals identified in the approved fire safety management plan, but not less than annually.

**10.9.2** Additional compliance audits shall be conducted prior to special events (*see Chapter 16*).

### 10.9.3 Closing Conference.

**10.9.3.1** The compliance audit shall include a closing conference with the fire safety manager and the governing body of the building upon completion of the periodic compliance audit.

**10.9.3.2** The closing conference shall identify all areas of noncompliance with the approved fire safety management plan.

**10.9.3.3** Following the periodic compliance audit, any deficiencies shall be addressed, with corrective action taken and documented in the fire safety log or as specified in the historic property's approved fire safety management plan.

**10.10\* Enforcement.** Where a compliance audit reveals noncompliance with the approved fire safety management plan or changes in the use or arrangement of the building, the AHJ shall be notified.

**10.11 Modification of Plan.** Proposed modification to the fire safety management plan shall be approved by the AHJ.

**10.12\* Procedures for Opening and Closing.** The property management plan shall include checklists identifying specific action required in conjunction with opening and closing the building on a daily basis and for any special events that are held at the property.

## Chapter 11 Fire Prevention

**11.1 General.** This chapter establishes minimum criteria for fire prevention in the operation of historic buildings and districts.

### 11.2 Decorations.

- ▲ **11.2.1\*** Decorative materials shall be noncombustible or be treated with an approved fire-retardant coating.

**11.2.2\*** Clearance between decorations and sources of ignition shall be not less than 36 in. (915 mm).

**11.2.3** Draperies, curtains, and other similar loosely hanging furnishings and decorations shall meet the flame propagation performance criteria contained in NFPA 701.

- ▲ **11.2.4\*** Fire-retardant treatment of historically significant fabrics shall not be required where such treatment will cause damage to the fabric.

■ **11.2.4.1\*** The provision of 11.2.4 shall apply only on an object-by-object basis.

■ **11.2.4.2** Approved alternative protection measures shall be implemented.

**11.2.5** The use of combustible vegetation, including natural cut Christmas trees, shall be in accordance with Section 10.14 of NFPA 1.

### 11.3 Fire Spread Control.

**11.3.1** Interior doors shall be kept closed when the building is not occupied except as permitted in 11.3.2.

**11.3.2** A risk analysis shall be performed where doors remain open for any of the following reasons:

- (1) To permit interior ventilation
- (2) To permit air movement critical to the conservation of historic building fabric
- (3) Where interior doors are part of the historic fabric

■ **11.3.2.1** The risk analysis required by 11.3.2 shall be documented.

■ **11.3.2.2** Alternative methods of controlling fire spread shall be implemented.

### 11.4\* Housekeeping.

**11.4.1 Means of Egress.** Stairs, corridors, doors, and any other portions of the means of egress for a building shall be maintained free of obstructions, combustibles, trash containers, and other materials.

### 11.4.2 Attics and Crawl Spaces.

▲ **11.4.2.1** Attics and crawl spaces shall be locked or otherwise secured.

▲ **11.4.2.2** Combustible materials shall not be stored in attics or crawl spaces unless such spaces are protected by approved automatic suppression systems.

### 11.4.3 Utility Rooms and Spaces.

■ **11.4.3.1** Electrical rooms, mechanical rooms, and telephone closets shall be kept free of combustible materials.

■ **11.4.3.2** Utility rooms and closets shall be locked or otherwise secured.

**11.4.4\* Air Handling Equipment.** Air handling equipment shall be cleaned as frequently as necessary to prevent the buildup of combustible dusts and fibers in accordance with manufacturers' guidelines.

**11.4.5 Voids.** Void spaces shall be kept clean and free of combustible materials.

### 11.4.6 Plenums.

**11.4.6.1** Plenums shall not be used for occupancy or storage. [90A:4.3.11.1.1]

**11.4.6.2** Accessible abandoned material shall be deemed to be in storage and shall be removed. Where cables are identified for future use with a tag, the tag shall be of sufficient durability to withstand the environment involved. [90A:4.3.11.1.2]

**11.4.6.3** The materials contained within plenums shall comply with NFPA 90A.



#### 11.4.7 Flammable and Combustible Liquids.

**N 11.4.7.1** Rags, clothing, and waste material contaminated with oils, such as animal or vegetable oils, paints, thinners, wax, furniture polish, and other liquids or compounds that could cause spontaneous heating shall be kept isolated from other combustibles and shall be stored in metal containers with tight-fitting metal lids.

**11.4.7.2** Ventilated metal lockers shall be provided for storage of highly combustible supplies and workers' clothing contaminated with combustible or flammable liquids.

**11.4.7.3** Flammable liquids shall be stored in approved safety containers in accordance with NFPA 30.

#### 11.4.8 Combustible Packing Materials.

**11.4.8.1\*** Combustible packing materials shall be stored in approved metal containers with self-closing covers.

**Δ 11.4.8.2** Where packing materials cannot be protected using metal containers with self-closing covers, dedicated crating and packing areas shall be enclosed by fire barriers having a 1-hour fire-resistance rating, or they shall be protected by an approved automatic sprinkler system.

#### 11.4.9 Trash and Trash Containers.

**11.4.9.1** Trash shall be collected and disposed of at the end of each work day and more often if necessary to prevent the accumulation of waste.

**11.4.9.2** Containers used for bulk collection of trash or recyclable paper shall be constructed of metal with metal covers.

**11.4.9.3** Dumpsters and other large trash containers inside buildings shall be stored as follows:

- (1) In trash rooms having both approved automatic sprinklers and a 1-hour fire resistance rating
- (2) In loading dock areas, separated from the rest of the building with a 2-hour fire resistance rating or 1-hour fire resistance rating and protected with automatic sprinklers

**11.4.9.4** Trash containers, dumpsters, and other central waste-disposal units, located outside, shall be a minimum distance of 15 ft (4.6 m) from all parts of a building exterior, including but not limited to, windows, doors, roof eaves, and utility controls.

#### 11.5 Smoking.

**11.5.1** Smoking shall be prohibited except for within designated, exterior smoking areas complying with 11.5.2 through 11.5.5.

**11.5.2** Smoking areas shall be clearly and publicly identified.

**11.5.3** Smoking areas shall be provided with noncombustible ashtrays or other receptacles for the proper disposal of smoking materials.

**N 11.5.4** Smoking areas shall be located not less than 15 ft (4.6 m) from any portion of a historical structure, or as required by local code, whichever is greater.

**11.5.5** Smoking areas shall be provided with not less than one portable fire extinguisher, selected and installed in accordance with NFPA 10.

#### 11.6 Open Flame Use.

**11.6.1 Approval.** Use of open flames and flame-producing devices, including but not limited to candles, oil lamps, fireplaces, forges, kilns, glassblowers, and cook stoves shall be permitted only where approved by the AHJ.

**11.6.2 Hot Work.** Hot work shall only be permitted when performed in accordance with 14.5.1.

**11.6.3 Precautions.** The following precautions shall be taken to control open flame and flame-producing devices:

- (1) All employees working around open flame or flame-producing devices shall be trained in the proper use and operation of the device, emergency response procedures, and portable fire extinguisher use.
- (2) Open flames and flame-producing devices shall be monitored constantly by a trained person.
- (3) A fire extinguisher selected in accordance with NFPA 10 shall be located within 30 ft (9.15 m) of the area where open flames or flame-producing devices are in use.
- (4) Candles shall be kept a minimum of 4 ft (1.22 m) from combustible window treatments and wall or ceiling hangings.
- (5) Fireplaces shall be covered with a fire screen when not used for cooking or similar demonstrations.
- (6) Open flames within 100 ft (31 m) of the building shall not be left unattended.
- (7) The use of open flames either inside or outside the building shall be extinguished prior to shutdown of the facility to ensure that the flame is completely extinguished.

#### 11.6.4 Chimneys.

**11.6.4.1** Fireplaces or stoves shall be used only where chimneys are in accordance with NFPA 211.

**11.6.4.2** Fireplaces or stoves shall be used only where chimneys are lined, provided with a spark arrester, and maintained in good working order.

**11.6.4.3** Chimneys serving active fireplaces or stoves shall be inspected and cleaned annually.

#### 11.7 Electrical Systems.

**11.7.1** Exposed electrical wiring of any type or extension cords shall not be placed across any means of egress.

**11.7.2\*** All electrical appliances, fixtures, or wiring shall be maintained in accordance with NFPA 70.

**Δ 11.7.3** Permanent wiring abandoned in place shall comply with 11.7.3.1 or 11.7.3.2.

**N 11.7.3.1** Permanent wiring abandoned in place shall be tagged or otherwise identified at its termination and junction points as "Abandoned in Place."

**N 11.7.3.2** Permanent wiring abandoned in place shall be removed from all accessible areas and insulated from contact with other live electrical wiring or devices.

**N 11.7.4** Where wiring is removed from accessible areas, penetrations through fire-resistance-rated assemblies shall be protected in accordance with the applicable building code.

**11.7.5\*** Electrical circuits throughout historic structures shall be protected with arc fault circuit interrupters (AFCIs). The

AFCIs shall be installed in the same manner as required in *NFPA 70* or other applicable code.

**11.7.6** Portable electrical appliances shall be provided with thermal and electrical limit controls that will cause the appliance to fail in a safe condition.

**11.7.7** Decorative lighting and similar accessories used for holiday lighting and similar purposes shall comply with Articles 410 and 590 of *NFPA 70* or other applicable code.

### 11.8 Cabling.

**11.8.1** Communication cabling, such as telecommunication, network, and protective systems cabling, including optical fiber cabling and cable systems, shall comply with the requirements of *NFPA 70* or other applicable code.

**11.8.2** Where any such cabling penetrates fire barriers or fire walls, such penetrations shall be protected in accordance with the applicable building code.

### 11.9 Heating, Ventilating, and Air-Conditioning (HVAC) Systems.

**11.9.1** Heating and air-conditioning systems shall be maintained in accordance with the manufacturer's specifications and applicable standards.

**11.9.2** Equipment shall be maintained in accordance with the standards identified in 15.6.1.

**11.9.3** Heating equipment and ductwork shall be kept free of flammable and combustible deposits.

### 11.9.4 Portable Heaters.

**11.9.4.1** The AHJ shall be permitted to prohibit the use of portable heaters in occupancies or situations where such use or operation would present an undue danger to life or property.

**11.9.4.2** Portable heaters shall be located so they cannot be overturned.

**11.9.4.3** All portable heaters shall be equipped with an automatic shutoff that activates when the unit is tilted or turned over.

**11.9.5** The use of unvented fuel-fired heating equipment shall be prohibited in historic buildings.

### 11.10 Commercial Cooking and Food Service Operations.

**11.10.1** Cooking shall be performed in kitchen facilities.

**11.10.2** Kitchens shall be maintained in a clean and orderly manner.

**Δ 11.10.2.1** Surfaces and equipment shall be kept free of grease.

**N 11.10.2.2** Food wastes shall be disposed of promptly.

**11.10.2.3** Means of egress from kitchens shall be maintained free of trash containers and other materials.

**11.10.3** Listed residential cooking appliances shall be permitted in kitchens, and shall be installed and maintained in accordance with their listings.

**11.10.4** Residential cooking appliances in kitchens that are not used for commercial cooking and are ancillary to the operation of the building, and where cooking does not produce

grease-laden vapors, shall be provided with a listed household/consumer hood.

**11.10.5** Listed commercial cooking appliances shall be provided with a hood and exhaust system, grease removal devices, auxiliary equipment, and fire-extinguishing equipment in compliance with *NFPA 96*.

**11.10.6** Equipment shall be used, inspected, and maintained in compliance with *NFPA 96*.

**11.10.7** Only nonflammable cleaners shall be used.

**11.10.8** Open-flame food warming devices shall be permitted to be used in constantly attended areas other than kitchens in accordance with 11.6.3 and where approved.

**N 11.10.9** Not less than one portable fire extinguisher shall be provided in accordance with 11.10.9.1 and 11.10.9.2.

**Δ 11.10.9.1** A portable fire extinguisher as required by *NFPA 10* shall be located within 10 ft (3.1 m) of any cooking, warming, or related operation.

**N 11.10.9.2** The location of the portable fire extinguisher required by 11.10.9.1 shall be marked with a sign complying with *NFPA 10*.

### 11.11 Access.

**11.11.1** An approved location at the site shall be designated as a command center and shall contain materials including the following:

- (1) Floor plans
- (2) Utility central plans
- (3) Emergency contact telephone numbers
- (4) Labeled keys
- (5) Appropriate safety data sheets
- (6) Other material as required by the AHJ

**11.11.2** Where security is of concern, an approved lockbox or other secure container shall be provided for the information identified in 11.11.1.

**11.12 Fire Proofing.** The fire safety manager shall inspect accessible structural fire proofing annually to ensure the material is in place and maintained in good condition.

**11.13 Lightning Protection.** The fire safety manager shall ensure that lightning protection systems, where installed, are inspected and maintained in good working condition by qualified personnel. See *NFPA 780*.

### 11.14 Protection from Wildland Fires.

**Δ 11.14.1** The governing body of a historic structure or district located in a wooded area or surrounded by fire-prone vegetation or heavy brush shall incorporate the requirements of *NFPA 1144* or other applicable code into the fire safety management component of the protection plan.

**11.14.2** Reduction of fuel loading in the landscape surrounding and owned by the historic structure shall be implemented in accordance with the requirements of *NFPA 1144* or other applicable code.

**11.14.3** Where the landscape is historic and either a contributing element to the property's historic designation, or designated itself, the governing body shall obtain the evaluation and recommendation of a professional historic landscape architect

for reducing fire loading that could threaten either the historic structure or the historic landscape.

**11.14.4** The evaluation shall include an analysis with respect to the requirements of NFPA 1144 or other applicable code.

**11.14.5** The resulting recommendations of the evaluation shall be included in the fire safety management component of the protection plan.

**11.14.6** Access roads shall be maintained and kept fully accessible at all times to accommodate fire service vehicles.

**11.15 Water Control.** Provisions shall be made for removal of accumulated water from manual and automatic fire fighting operations.

## Chapter 12 Security

### 12.1 Security Systems.

**12.1.1\* General.** Where the security plan requires physical security devices, they shall be installed and maintained in accordance with the manufacturer's specifications.

#### 12.1.2\* Electronic Premises Security Systems.

**12.1.2.1** Where required by the security plan, an electronic premises security system shall be designed, installed, and maintained by qualified persons in accordance with NFPA 731.

**12.1.2.2** Electronic premises security systems shall be installed in compliance with NFPA 731.

**12.1.2.3** The following documentation, upon final acceptance of every system, shall be delivered to the party responsible for the protected premises:

- (1) Owner's manual
- (2) User's instructions
- (3) A record of completion by the system installer
- (4) Name and contact telephone number of the organization maintaining the electronic premises security system
- (5) Name and contact telephone number of the organization monitoring the electronic premises security system displayed at the control unit
- (6) Any other documentation required by law or the AHJ

**12.1.2.4** Where required by the security plan, emergency communication systems shall comply with *NFPA 72*.

#### 12.2\* Access Control.

**12.2.1\*** Where required by the security plan, electronic access control systems shall be designed, installed, and maintained by qualified persons in accordance with NFPA 731.

**12.2.2\*** Where locking devices are required by the security plan, a key management strategy shall be implemented.

**12.3\* Video Surveillance Systems.** Where required by the security plan, video surveillance systems shall be designed, installed, and maintained by qualified persons in compliance with NFPA 731.

**12.4\* Exterior Lighting Systems.** Where required by the security plan, exterior lighting systems shall be designed, installed, and maintained in accordance with the manufacturer's specifications.

### 12.5 Construction Areas.

**12.5.1** Access to construction areas shall be restricted to personnel authorized by the owner or the contractor.

**12.5.2\*** Where assigned, security officers shall receive daily updates from those responsible for construction on the status of and impairments to the fire protection equipment and security systems and on the status of special hazards, including hot work, modified access routes, and emergency procedures.

**12.5.3** Existing electronic premises security systems and physical security systems shall be maintained in proper working order during the project to the extent practicable.

**12.5.4** Openings that provide access into protected areas in the historic structure shall be covered or secured to prevent unauthorized access.

**12.5.5** Ladders and stairways on scaffolding that provide access to upper levels of the historic property shall be secured to prevent unauthorized persons from using the scaffolding to gain access to the facility.

## Chapter 13 Additions, Alterations, and Rehabilitation

**13.1 General.** Additions, alterations, and rehabilitation shall comply with the applicable building code and this code.

### 13.2 Construction Oversight.

**13.2.1 Contractor Selection.** Contractors selected to work on the project shall have a demonstrated knowledge of and experience in working with historic structures.

#### 13.2.2 Initial Meeting/Indoctrination of Contractors.

**13.2.2.1** Prior to beginning work on the project, an introductory meeting shall be held with the contractors, subcontractors, and representatives of the historic structure.

**13.2.2.2** All persons involved with the construction process shall be thoroughly briefed on the significance and importance of the structure, spaces, and character-defining features, prior to beginning work.

**13.2.2.3** The initial meeting shall cover the project fire safety program, as defined in Chapter 14.

**13.2.3 Supervision During Construction.** The governing body of the historic structure shall designate its own representative who shall have the authority to specify additional protection requirements for the construction project necessary to safeguard the existing facility and fabric.

**13.2.3.1** The governing representative shall have the authority to enforce the historic structure's protection requirements and to stop work or other activities when the work or activities jeopardize the safety or security of the facility.

**13.2.3.2** This supervision shall include the following:

- (1) Site security and monitoring of contractors and visitors
- (2) Isolation of construction from the existing building
- (3) Location and handling of flammable liquids and gases
- (4) Removal of rubbish and combustibles
- (5) Hot work and other sources of ignition
- (6) Handling of sprinklers and other fire protection system components

(7) Location and type of portable extinguishers to be used in the proximity of historic fabric

**13.2.3.3** Following suspension of work each day, the governing body representative or his or her designee shall conduct a walk-through of the work area and surroundings to ensure that the site is secured and hazards have been eliminated or controlled.

**N 13.3\* Fire Protection and Life Safety Systems Commissioning.**

Where structures undergo additions, alterations, or rehabilitation, the impacted portions of fire and life safety systems shall be commissioned in accordance with NFPA 3.

**13.4 Fire Spread Control.**

**13.4.1** New openings in fire-rated assemblies, such as doorways and duct penetrations, shall have self-closing or automatic fire doors and automatic fire dampers having fire resistance ratings in accordance with the applicable building code.

**13.4.2** Penetrations in fire-rated assemblies, such as those around cabling, pipes, and ducts, shall be sealed with approved materials to maintain the integrity of the fire-rated assembly.

**13.4.3** New elevator shafts, dumbwaiters, stairways, and other vertical openings through the structure shall be constructed in a manner that prevents the spread of fire, smoke, and heat from one level to another.

**13.4.4** New doors in fire-rated assemblies required to remain in the open position for any reason shall be equipped with approved door-holding devices controlled by a listed smoke detector.

**13.5 Fire Protection Systems.**

**13.5.1 Commercial Cooking Equipment.** Commercial cooking equipment shall be protected in accordance with NFPA 96.

**13.5.2 Fire Alarm Systems.** Any fire alarm system shall be installed, tested, and maintained in accordance with the applicable requirements of *NFPA 72*.

**13.5.2.1** Where automatic sprinklers are not installed, smoke detectors shall be installed in every area and space where ambient conditions permit.

**13.5.2.2** Where ambient conditions will adversely affect the performance, reliability, and normal operation of smoke detectors, other forms of detection technology, such as heat detection, shall be used.

**13.5.2.3 Alarm Monitoring.**

**13.5.2.3.1** Fire detection and alarm systems and automatic fire suppression systems shall transmit alarm, supervisory, and trouble signals to an approved monitoring facility.

**13.5.2.3.2** The monitoring facility and the communications method used for alarm signal transmission shall comply with the requirements of *NFPA 72*.

**13.5.3 Automatic Sprinkler Systems.**

**Δ 13.5.3.1** Any automatic sprinkler system shall be in accordance with one of the following standards, in accordance with their scopes:

- (1) NFPA 13
- (2) NFPA 13D
- (3) NFPA 13R

**13.5.3.2** Standard response sprinklers shall be permitted for use in light hazard areas.

**13.5.4 Other Automatic Extinguishing Systems.**

**13.5.4.1** In any occupancy where the character of the potential fuel for fire is such that extinguishment or control of fire is effectively accomplished by a type of automatic extinguishing system other than an automatic sprinkler system, or where protection of the building's historic character will be optimized by a type of automatic extinguishing system other than an automatic sprinkler system, such systems shall be installed in accordance with this section.

**Δ 13.5.4.2** Other automatic extinguishing systems shall be installed, tested, and maintained in accordance with the applicable requirements of the standards identified in Table 13.5.4.2.

**13.5.5 Portable Fire Extinguishers.**

**13.5.5.1** Portable fire extinguishers shall be selected, located, mounted, and maintained in accordance with NFPA 10.

**13.5.5.2** One approved portable fire extinguisher shall be readily accessible on each floor near each usable stairway.

**13.5.6 Standpipe Systems.** Any standpipe and hose system shall be provided in accordance with NFPA 14.

**13.6 Roof Coverings.**

**13.6.1** Unlisted combustible roof coverings shall be treated with an approved fire-retardant coating.

**13.6.1.1** A fire-retardant coating shall not be required when it would harm historic fabric.

**13.6.2** The facility shall maintain a record of this treatment, including certificates of approval of retardant, application method, and re-treatment schedule.

**13.6.3** Fire-retardant coated roof coverings shall be re-treated in accordance with the manufacturer's specifications.

**13.7 Electrical Systems.**

**13.7.1** The installation of all new electrical systems, appliances, and equipment shall be in accordance with *NFPA 70* or other applicable code.

**13.7.2** All existing electrical systems, appliances and equipment to be retained shall be fully evaluated and tested. All deficiencies and unsafe conditions shall be corrected to conform with *NFPA 70* or other applicable code.

**Δ Table 13.5.4.2 Fire Suppression System Installation Standards**

Fire Suppression System	Installation Standard
Low-, medium-, and high-expansion foam	NFPA 11
Carbon dioxide	NFPA 12
Halon 1301	NFPA 12A
Water spray fixed	NFPA 15
Deluge foam-water sprinkler	NFPA 16
Dry chemical	NFPA 17
Wet chemical	NFPA 17A
Water mist	NFPA 750
Clean agent extinguishing	NFPA 2001

### 13.7.3 Emergency Power.

**13.7.3.1** Emergency generators, where required, shall comply with the requirements of NFPA 110.

**13.7.3.2** Emergency generators shall have sufficient capacity to support critical fire safety functions and fire suppression systems, where required.

**13.7.3.3** Emergency generators that support other functions considered essential shall have sufficient capacity to support all functions with no degradation of fire safety system support.

**13.8 Hazardous Areas.** Newly constructed hazardous areas shall be separated from other areas by a fire separation with a minimum of 1-hour fire resistance rating.

### 13.9 Interior Finishes.

**13.9.1** Newly installed interior finish materials shall prevent flames from spreading rapidly and generating dangerous amounts of smoke and toxic products of combustion.

**13.9.2** Newly installed interior finish materials shall comply with the requirements of the applicable building code.

### 13.10 Lightning Protection.

**13.10.1** A lightning protection system, where required, shall be designed, installed, and maintained in accordance with NFPA 780.

**13.10.2** Existing lightning protection systems shall be tested and repaired where necessary as part of the addition, alteration, or renovation work.

### 13.11 Protection from Wildland Fires.

**13.11.1** The governing body or party responsible for cultural resource properties located in areas that are wooded or surrounded by fire-prone vegetation or heavy brush shall incorporate the requirements of NFPA 1144 into the facility's or institution's fire protection program and plan.

**13.11.2** Reduction of fuel loading in the landscape surrounding and owned by the cultural resource property shall be implemented in accordance with the requirements of NFPA 1144.

**13.11.3** Where the landscape is historic and either a contributing element to the property's historic designation, or is designated itself, the governing body or responsible party shall obtain a professional historic landscape architect evaluation and recommendation for reducing fire loading that could threaten either the cultural resource property or the historic landscape.

**13.11.4** The evaluation shall include an analysis with respect to the requirements of NFPA 1144.

**13.11.5** The resulting recommendations of the evaluation shall be included in the fire protection program and plan.

**13.11.6** Access roads shall be maintained and kept fully accessible at all times to accommodate fire service vehicles.

### **N** 13.12\* Integrated Fire Protection and Life Safety Systems.

**N** 13.12.1 Where integrated fire protection and life safety systems are utilized, they shall be tested in accordance with NFPA 4.

**N** 13.12.2 An integrated systems test plan shall not be required for buildings with limited integrated systems. [4:4.5.3]

**N** 13.12.3 If an integrated system test plan is not required, integrated system testing is still required. [4:4.5.3.1]

**13.13 Water Control.** Provisions shall be made for removal of accumulated water from manual and automatic fire-fighting operations.

## Chapter 14 Fire Precautions During Construction, Repair, and Alterations

### 14.1 General.

**14.1.1\*** All persons involved with the design of the building, exhibits, and other aspects of the project shall have a demonstrated knowledge of the historic significance of the structure.

**14.1.2\*** All persons involved with the construction process shall be thoroughly briefed on the significance and importance of the structure, spaces, and character-defining features, prior to the beginning of the work.

**14.1.3\* Contractor Selection.** Contractors selected to work on the project shall have a demonstrated knowledge and experience in working with historic structures.

**14.1.4\* Contracts.** All construction, alteration, or renovation contracts shall specify methods and responsibility for controlling fire hazards.

**14.1.5\* Initial Meeting/Indoctrination of Contractors.** Prior to beginning work on projects, an introductory meeting shall be held with the contractors, subcontractors, and representatives of the historic structure in accordance with 13.2.2.

### 14.2 Fire Protection Systems.

**14.2.1** Alterations or renovations of fire protection systems shall comply with the provisions of Section 13.5 and the applicable building code.

**14.2.1.1** Temporary protection strategies using performance-based designs that incorporate nontraditional use of fire protection systems shall be permitted where such designs comply with the requirements of Chapter 9 of this code.

**14.2.2** Alterations or renovations of fire protection systems shall be approved by the AHJ.

**14.2.3 Impairments.** The provisions of Section 15.4 shall apply when fire protection systems or equipment are taken out of service.

### 14.3 Precautions.

**14.3.1 Contracts.** All construction, alteration, or renovation contracts shall specify methods and responsibilities for controlling fire hazards.

**14.3.2** Construction, alterations, and renovations shall comply with requirements for safeguarding construction activities in accordance with NFPA 241 and other applicable codes or standards.

### 14.3.3 Supervision.

**14.3.3.1** Responsibility for enforcement of the terms of the contract relating to fire hazards shall be assigned, and authority shall be given to stop work pending correction of hazards.

**14.3.3.2** The AHJ shall be consulted.

#### 14.3.4 Temporary Enclosures.

**14.3.4.1** Only noncombustible panels, flame-resistant tarpaulins, or approved materials of equivalent fire-retardant characteristics shall be used.

**14.3.4.2** Any other fabrics or plastic films used shall be certified as conforming to the requirements of Test Method 2 contained in NFPA 701.

**14.3.4.3** Where used to enclose structures, forming equipment, and similar items, the enclosing material shall be fastened securely or guarded by construction so it cannot be blown by the wind against heaters or other sources of ignition.

**▲ 14.3.4.4** Fire extinguishers shall be accessible and protected from accidental damage in accordance with NFPA 10.

#### 14.3.5 Smoking.

**14.3.5.1** Smoking shall be prohibited inside any building, building space, or area under construction, renovation, or repair.

**14.3.5.2** Where contractors and workers are permitted to smoke, the fire safety manager or the responsible party for the institution or property shall designate a smoking area outside of the work area at a distance approved by the AHJ.

**14.3.5.3** The designated smoking area shall be clearly and publicly identified and shall be located a sufficient distance away from all combustible and flammable materials or liquids to prevent a fire from starting.

**14.3.5.4** Receptacles for spent smoking materials shall be provided in the designated smoking area.

**14.3.5.5** A portable fire extinguisher, in compliance with the provisions of NFPA 10, shall be located at each designated smoking area.

#### 14.3.6 Ignition Sources.

**14.3.6.1** Hot work operations shall comply with 14.5.1.

**14.3.6.2** Portable heating appliances shall comply with 14.5.2.

**14.3.6.3** On-site recharging of gas cylinders shall be prohibited.

**14.3.6.4** Temporary lighting and wiring shall comply with the requirements of NFPA 70.

**14.3.6.5** Gasoline-powered engines, such as those used in compressors and hoists, shall not be permitted inside the building.

#### 14.3.7 Housekeeping.

**14.3.7.1** The accumulation of debris or rubbish shall not be permitted inside construction areas or close to a source of ignition.

**14.3.7.2** Debris and rubbish shall be removed daily from the site and shall not be burned in the vicinity.

**14.3.7.3** Contractors shall provide metal receptacles with metal lids for rubbish, papers, and other debris.

**14.3.7.4** Where construction debris is removed from the upper floors of a building, it shall be conveyed to containers by means of a chute erected on the outside of the building.

**14.3.7.5** Where exterior chutes are used, the lower section of the chute shall be disconnected or removed to a point not less than 10 ft (3.1 m) above the dumpster at the close of each work day.

**14.3.7.6** Burning waste materials on the premises shall not be permitted.

**14.3.8 Flammable and Combustible Liquids.** No more than a one-day supply of paint thinners, solvents, and other flammable and combustible liquids used in the project shall be kept in the building.

**14.3.8.1** Flammable liquids shall be stored in approved safety cabinets and containers.

**14.3.8.2** The provisions of NFPA 30 on limits of storage of flammable and combustible liquids inside buildings shall apply.

**14.3.8.3** Quantities of flammable and combustible liquids in excess of those necessary to complete a day's work shall be stored at least 50 ft (15.2 m) away from the main construction project.

**14.3.8.4** Gasoline-powered engines, such as those used in compressors and hoists, shall not be permitted inside the building.

#### 14.3.9 Fire Protection Systems.

##### 14.3.9.1 Fire Detection Systems.

**14.3.9.1.1** Existing fire detection and alarm systems shall be maintained in working order during the project to the extent consistent with the nature of the construction.

**14.3.9.1.2** Smoke detectors within the construction area shall be removed or shall be protected from dust, dirt, and extreme temperatures during construction.

**14.3.9.1.3** Smoke detectors inside the construction area that are covered to keep out dust and dirt while work is in progress shall be uncovered at the end of each work day.

**14.3.9.1.4** After final construction cleanup by all trades, all smoke detectors shall be cleaned or replaced in accordance with NFPA 72.

**14.3.9.1.5** Reacceptance testing in accordance with NFPA 72 shall be performed after any adjustment, modification, or repair to any fire detection system wiring or component.

##### 14.3.9.2 Fire Suppression Systems.

**14.3.9.2.1** Automatic fire suppression systems shall be kept in working order during the project to the extent consistent with the nature of the construction.

**14.3.9.2.2** Disconnected or shutoff standpipes or fire suppression systems shall be restored to service as soon as it is practical.

**14.3.9.2.3** Inspections of standpipe and sprinkler valves shall be conducted and recorded in accordance with the provisions of NFPA 25.

**14.3.9.2.4** Fire hydrants, sprinklers, standpipe and sprinkler fire department connections, and hose outlet valves shall not be obstructed and shall be maintained in accordance with NFPA 25.

#### 14.4 Temporary Construction and Equipment.

##### 14.4.1 Construction Offices and Sheds.

**14.4.1.1** Temporary offices, trailers, sheds, and other temporary facilities of combustible construction shall comply with Chapter 4 of NFPA 241.

**14.4.1.2** Heating devices used in construction offices and sheds shall be listed.

**14.4.1.3** A minimum clearance of 36 in. (915 mm) shall be maintained around stoves and heaters, and a minimum clearance of 6 in. (152 mm) shall be maintained around all chimney and vent connectors, to prevent ignition of adjacent combustible materials.

**14.4.1.4** Structures, equipment, and materials shall not impede egress of occupants or workers from the building or hinder access by fire apparatus to the building and hydrants.

**14.4.1.5** The areas beneath all temporary offices and other facilities shall not be used for the storage of construction materials, equipment, or supplies, and measures shall be put in place to ensure that no combustible waste matter is allowed to accumulate in these areas.

##### 14.4.2 Construction Equipment and Materials.

###### 14.4.2.1 Equipment.

**14.4.2.1.1** Internal combustion engine-powered air equipment, such as compressors, hoists, derricks, and pumps, shall be placed so the exhaust discharges away from combustible materials and air intakes for the building heating, ventilation, and air-conditioning (HVAC) system.

**14.4.2.1.2** A minimum clearance of 6 in. (152 mm) shall be maintained between equipment exhaust piping and combustible materials.

**14.4.2.1.3** Service areas and fuel for construction equipment shall not be located inside the building.

###### 14.4.2.2 Materials.

**14.4.2.2.1\*** Storage of flammable and combustible liquids shall comply with 14.3.8.

**14.4.2.2.2** Combustible construction components stored inside the building shall be limited to the minimum required to complete a day's project.

**14.4.2.2.3** Where steel construction is present, combustible storage shall not be placed in areas where specified fire-resistive coatings have not been applied to structural members.

**14.4.2.2.4** Storage of highly combustible materials such as foam, plastic, and rubber products, shall not be permitted inside the building.

**14.4.2.2.5** Storage of construction materials shall not impede egress from buildings or access of fire apparatus to hydrants or to the building.

**14.4.2.2.6** Tarpaulins or plastic sheeting, where used, shall meet the flame propagation requirements contained in NFPA 701.

#### 14.5 Construction Processes and Hazards.

**14.5.1 Cutting, Welding, and Other Hot Work Operations.** Cutting, welding, and other hot work operations shall comply with the requirements of NFPA 51B.

**14.5.1.1** The person designated to be in charge of fire protection shall issue a hot work permit each day that cutting and welding and other hot work operations are being conducted, as required by Section 11.6.

**14.5.1.2** At the close of the work day the person responsible for fire protection on the site shall inspect areas where welding and cutting or other hot work operations have been conducted, for hot metal or smoldering combustible materials.

**14.5.1.3** Flammable gas cylinders used in the welding or cutting process shall be protected from vehicle damage and high temperatures.

##### 14.5.2 Temporary Heating Equipment.

**14.5.2.1** Temporary heating equipment shall be listed for the purpose and used and installed in accordance with the listing.

**14.5.2.2** Temporary heating equipment shall comply with NFPA 31, NFPA 54, and NFPA 58.

**14.5.2.3** Temporary heating equipment shall be used only on a stable surface in a protected location where they will not be overturned.

**14.5.2.4** Portable equipment using oil or liquefied petroleum gas as fuel shall be removed to a well-ventilated area away from combustible materials and allowed to cool prior to refueling.

**14.5.2.5** A portable fire extinguisher selected in accordance with NFPA 10 shall be located within 30 ft (9.1 m) of all portable heating devices.

**14.5.2.6** Chimney or vent connectors from direct-fired heaters, where required, shall be maintained at least 18 in. (457 mm) from combustible materials.

**14.5.2.7** Temporary heating equipment shall be attended and maintained by trained personnel.

##### 14.5.3 Roofing.

###### 14.5.3.1 General.

**14.5.3.1.1** The provisions of this section shall apply to any type of equipment including, but not limited to, chassis-mounted equipment used for preheating or heating tar, asphalt, rubberized asphalt, pitch, or similar substances for roofs, floors, pipes, or similar objects. [1:16.7.1.1]

**14.5.3.1.2** Operating kettles shall not be located inside of or on the roof of any building. [1:16.7.2.1]

**14.5.3.2 Tar Kettle Location.** The kettle shall be operated in a controlled area. The area shall be identified by the use of traffic cones, barriers, and other suitable means as approved by the AHJ. [1:16.7.2.2]

###### 14.5.3.3 Kettle Supervision.

**14.5.3.3.1** An operating kettle shall be attended by a minimum of one employee who is knowledgeable of the operations and hazards. [1:16.7.2.3.1]

**14.5.3.3.2** The employee shall be within 25 ft (7.6 m) of the kettle and shall have the kettle within sight. [1:16.7.2.3.2]

#### 14.5.3.4 Fire Extinguishers for Tar Kettles.

**14.5.3.4.1** Two approved 4-A:40-B:C fire extinguishers shall be provided and maintained within 25 ft (7.6 m) of the operating kettle. [1:16.7.2.4.1]

**14.5.3.4.2** A minimum of one approved 4-A:40-B:C fire extinguisher shall be provided and maintained on the roof in close proximity to the roofing operations while the roofing material is being applied. [1:16.7.2.4.2]

#### 14.5.3.5 Exits.

**14.5.3.5.1** Roofing kettles shall not block exits, means of egress, gates, roadways, or entrances. [1:16.7.2.5.1]

**14.5.3.5.2** Kettles shall not be closer than 10 ft (3 m) from exits or means of egress. [1:16.7.2.5.2]

#### 14.5.3.6 Liquefied Petroleum Gas (LP-Gas).

**14.5.3.6.1** Cylinders or containers used for fueling tar kettles shall be protected against tampering and vandalism.

**14.5.3.6.2** Containers shall be kept a minimum distance of 20 ft (6 m) from combustible materials or spare containers.

**14.5.3.6.3** When possible, cylinders and containers shall be placed in a secured area for protection against tampering.

**14.5.3.6.4** Cylinders or containers that cannot be secured in a protected area shall have the dome covers locked and secured, or the valve handle shall be removed or secured in the "off" position.

**14.5.3.6.5** Storage of LP-Gas cylinders on rooftops shall not be permitted.

#### 14.5.4 Plumbing.

**14.5.4.1** Plumbing work involving open flames shall be conducted only under the supervision of the person in charge of fire protection and shall require a hot work permit reissued each day.

**14.5.4.2** The provisions of 14.5.1 shall apply to cutting and welding operations.

#### 14.5.5 Demolition Work.

**14.5.5.1** Gas supplies shall be shut off at a point outside the affected area and shall be capped.

**14.5.5.2** Electrical service shall be reduced or eliminated in the affected area.

**14.5.5.3** Hot work shall not be permitted in combustible buildings except as outlined in Section 11.6.

**14.5.5.4** Fire walls, fire barrier walls, fire doors, and other fire separation assemblies shall have their integrity or operation maintained.

**14.5.6 Other Hazardous Operations.** The owner or governing body shall conduct a hazard assessment of operations that introduce fire hazards to determine if the risk is consistent with the facility's fire safety objectives.

**14.5.6.1** Paint stripping operations involving heat-producing devices shall not be permitted.

**14.5.6.2** Floor sander dust accumulation bags shall be emptied into closed metal containers outside of the building before the close of the day.

#### 14.5.7 Electrical.

**14.5.7.1** Prior to construction, the electrical equipment and circuits that might be impacted by or used during the alteration, addition, or renovation work shall be identified, relocated as needed, and made safe by approved personnel.

**14.5.7.2** Electrical wiring and equipment shall comply with the requirements of *NFPA 70*.

**14.5.7.3\*** Temporary lighting, bulbs, and fixtures shall be installed so they do not come in contact with combustible materials.

**14.5.7.4** Circuit breakers for circuits that are not in use shall be shut off and tagged.

**14.5.7.5** Temporary wiring shall be removed immediately upon elimination of the need for which the wiring was installed.

**14.5.8 Environmental Conditions.** Openings in structures susceptible to damage from high winds that could cause skewing and misalignment of the structure, disruption of water supplies, or delivery systems for fire protection shall have secure coverings.

#### 14.6 Fire Resistive Construction.

**14.6.1** The construction, repair, or modification of walls, horizontal assemblies, and similar construction, and the installation of opening protectives required to comply with provisions of the applicable building code shall be completed as soon as practical.

**14.6.2** Fire doors with approved closing devices and hardware shall be installed as soon as practical and before combustible materials are introduced.

**14.6.3** Fire doors shall be operable and unobstructed.

#### 14.7 Fire Suppression.

##### 14.7.1 Fire Incident Response.

**14.7.1.1\*** An approved location at the site shall be provided with floor plans, utility control plans, emergency contact telephone numbers, labeled keys, and material safety data sheets.

**14.7.1.2** Where security is of concern, the location specified by 14.7.1.1 shall be locked.

**14.7.2** Access for heavy fire-fighting equipment to the immediate job site shall be provided at the start of construction and maintained until all construction is completed.

**14.7.3** Free access from the street to fire hydrants and to outside connections for standpipes, sprinklers, or other fire-extinguishing equipment, whether permanent or temporary, shall be provided and maintained at all times.

**14.7.4** Protective pedestrian walkways shall be constructed so as not to impede access to hydrants, fire department connections, or fire-extinguishing equipment.

**14.7.5** During construction operations, free access to permanent, temporary, or portable fire-extinguishing equipment and systems shall be maintained.



**14.7.6** At least one stairway shall be provided in usable condition at all times in multistory buildings.

**14.8 Water Supply.** Water for fire suppression shall be available throughout all phases of construction.

#### **14.9 Standpipe Systems.**

**14.9.1** New standpipes that are required or existing standpipes in buildings being altered shall be maintained in accordance with the progress of building activity, such that the standpipes are always ready for fire department use.

**14.9.2** Class I manual dry standpipes shall be permitted where approved by the AHJ.

**14.9.3** Where fire suppression systems existed prior to the rehabilitation project, the system shall be kept in service as long as possible during the rehabilitation work.

#### **14.10 Automatic Fire Suppression Systems.**

**14.10.1** Where required by the responding fire department, hoses and nozzles shall be provided and made ready for use, as either the temporary or permanent water supply becomes available.

**14.10.2** Where automatic fire suppression systems are provided, the installation shall be placed in service and monitored as soon as it is practical.

**14.10.3** Where fire suppression systems must be taken out of service for modification, the local fire department shall be notified and the system shall be returned to service as soon as possible.

#### **14.11 Portable Fire Extinguishers.**

**14.11.1** Portable fire extinguishers shall be protected from accidental damage in accordance with NFPA 10.

**Δ 14.11.2** At least one portable fire extinguisher selected and installed in accordance with NFPA 10 shall be accessible on each floor near each usable stairway.

#### **14.12 Emergency Communication.**

**14.12.1** Prior to beginning any renovations or alterations, workers shall be instructed on emergency communications procedures.

**14.12.2** A fixed telephone or equivalent method of summoning the fire service shall be provided and available.

**14.12.3** The telephone number of the fire service shall be prominently posted on or immediately adjacent to each telephone.

**14.12.4** Written instructions that include the following information shall be posted:

- (1) Building or site address
- (2) Procedures for notification of the local fire service in the event of a fire
- (3) Actions for security officers or other staff after notifying the fire service

**14.12.5** Upon activation of a fire alarm or other notification device, or identification of an actual fire, personnel shall evacuate the building.

## **Chapter 15 Inspection, Testing, and Maintenance**

### **15.1\* General.**

**15.1.1** This chapter shall establish the requirements for critical and regular inspection, testing, and maintenance of protection features, systems, and devices in historic structures and districts.

**15.1.2** Records of inspection, testing, and maintenance activities shall be retained until the occurrence of the next activity and for 1 year thereafter.

### **15.2 Responsibility.**

**15.2.1** The responsibility for maintenance of protection features, systems, and devices shall be that of the owner or governing body or responsible party of the historic structure or district.

**15.2.2** Inspection, testing, and maintenance shall be implemented in accordance with procedures meeting or exceeding those established in the standard for that type of protection feature, system, or device, and shall be in accordance with the manufacturer's instructions.

**15.2.3** Personnel who have developed competence through training and experience shall perform inspection, testing, and maintenance of protection features, systems, and devices.

### **15.3 Fire Protection Systems.**

**Δ 15.3.1 Requirements.** All fire protection systems shall be inspected, tested, and maintained in full compliance with the manufacturer's recommendations and with the standards identified in Table 15.3.1, as applicable.

**15.3.2 Inspection.** Inspection activities, frequencies, responsibilities, routines, and reporting procedures shall comply with the standards identified in Table 15.3.1 or other approved standards as applicable.

#### **15.3.3 Testing.**

**15.3.3.1** Testing activities, frequencies, responsibilities, routines, and reporting procedures shall comply with the standards identified in Table 15.3.1, or other approved standards as applicable.

**15.3.3.2** All fire protection systems shall be tested to verify that they function as intended.

**Δ Table 15.3.1 Inspection, Testing, and Maintenance Codes and Standards — Fire Protection Systems**

Type of System	NFPA Standard
Integrated systems	NFPA 4
Carbon dioxide	NFPA 12
Halon 1301	NFPA 12A
Dry chemical	NFPA 17
Wet chemical	NFPA 17A
Water-based	NFPA 25
Alarm and detection	NFPA 72
Smoke control	NFPA 92
Cooking equipment	NFPA 96
Smoke and heat venting	NFPA 204
Water mist	NFPA 750
Clean agent	NFPA 2001

**15.3.3.3** Test results shall be compared with those of the original acceptance test (if available) and with the most recent test results.

**N 15.3.3.4\*** Integrated fire protection systems shall be tested in accordance with NFPA 4.

#### **15.3.4 Maintenance.**

**15.3.4.1** Maintenance activities, frequencies, responsibilities, routines, and reporting procedures shall comply with the standards identified in Table 15.3.1 or other approved standards as applicable.

**15.3.4.2** Maintenance shall be performed to keep all fire protection systems operable. Necessary repairs shall be made.

**15.3.4.3** As-built system installation drawings, original acceptance test records, and device or equipment manufacturer's maintenance bulletins shall be retained by the fire safety manager to assist in developing and maintaining the inspection, testing, and maintenance standards for all fire protection equipment and systems and components.

#### **15.4 Impairments to Fire Protection Systems.**

**15.4.1 General.** When an emergency or a preplanned impairment takes any fire protection system out of operational service, adequate measures shall be taken during the impairment to ensure that increased risks are minimized and the duration of the impairment is limited.

**15.4.1.1** When any fire protection system is out of service for 4 hours or more, the owner or governing body shall notify the fire department and post a fire watch.

**15.4.1.2** The fire watch shall be provided with an approved means of notification of the fire department.

#### **15.4.2 Preplanned Impairments.**

**15.4.2.1** All preplanned impairments shall be authorized in advance of work by the fire safety manager.

**15.4.2.2** The fire safety manager shall be responsible for verifying that written procedures for impairments are followed before authorizing a system impairment. (See 15.4.3.)

#### **15.4.3 Procedure.**

**15.4.3.1** A written procedure shall be established and implemented by the owner or governing body to control any emergency or preplanned impairment.

**15.4.3.2** The written procedure shall include, as a minimum, the following:

- (1) Identification and tagging of all impaired equipment and systems
- (2) Inspection/risk evaluation
- (3) Identification of extent or expected duration of impairment
- (4) Notification of the fire department
- (5) Notification of other personnel or organizations as appropriate
- (6) Statement of additional measures deemed necessary for the duration of the system impairment
- (7) Actions to be taken and notifications to be made when all impaired equipment and systems are restored to operational service

(8) Prior to a preplanned impairment, assembly of all necessary parts, tools, materials, and labor at the impairment site before removing the system or equipment from service

(9) Expedition of all repair work

**15.4.4 Restoring Systems to Service.** When all impaired systems are restored to operational service, the impairment coordinator shall verify that the following procedures have been completed:

- (1) Any necessary inspections and tests required in accordance with 15.3.1 for the fire protection system or equipment involved have been conducted to verify that affected systems and equipment are operational.
- (2) Those individuals listed in 15.4.3.2(5) have been advised that protection has been restored.
- (3) Impairment tags shall have been removed.

#### **15.5 Electronic Premises Security Systems.**

**15.5.1** All electronic premises security systems shall be inspected, tested, and maintained in full compliance with the manufacturer's recommendations.

**15.5.2** Inspection, testing, and maintenance of electronic premises security systems shall be performed by personnel who have developed competence through training and experience.

**15.5.3** Inspection and testing frequencies and test routines shall comply with manufacturers' recommendations.

#### **15.5.4 Testing.**

**15.5.4.1** All electronic premises security systems shall be tested to verify that they function as intended.

**15.5.4.2** Test results shall be compared with those of the original specifications for the system, the results of the original acceptance test (if available), and the results of the most recent test. Any variances in the performance of the system shall be documented and corrections made to bring the system performance to an acceptable level.

#### **15.5.5 Maintenance.**

**15.5.5.1** Maintenance shall be performed to keep all electronic premises security systems operable. Necessary repairs shall be made.

**15.5.5.2** As-built system installation drawings, original acceptance test records, and device or equipment manufacturer's maintenance bulletins shall be retained by the governing body to assist in developing and maintaining the inspection, testing, and maintenance standards for all electronic premises security systems, equipment, and components.

#### **15.6 Heating, Air-Conditioning, and Cooking Equipment.**

**15.6.1** Heating and air-conditioning systems and cooking appliances shall be maintained in accordance with the manufacturer's specifications and shall comply with NFPA 90A, NFPA 90B, and NFPA 96.

**15.6.2** Heaters and ductwork, including hoods and ducts for cooking appliances, shall be kept free of flammable and combustible deposits.

**15.7 Chimneys.** Chimneys for active stoves or fireplaces shall be inspected and cleaned annually in accordance with NFPA 211.

**15.8 Electrical Systems.** Electrical systems shall be maintained in compliance with *NFPA 70* or other applicable codes, and the manufacturer's instructions.

**15.9 Fire Walls and Fire Barrier Walls.** The integrity of fire walls and fire barrier walls shall comply with the applicable building code. Openings in such walls shall be protected and maintained in accordance with *NFPA 80*.

**15.10 Fire-Retardant-Treated Materials.** Applied coatings and treatments shall be maintained in accordance with *NFPA 703*.

**15.11 Fire Extinguishers.** Portable fire extinguishers shall be maintained in accordance with *NFPA 10*.

## Chapter 16 Special Events

### 16.1\* General.

**16.1.1** Plans for special events shall be reviewed and approved by the governing body and, where required, by the authority having jurisdiction.

**16.1.2** Where required by the AHJ, a fire emergency response plan shall be prepared in accordance with Section 10.5.

### 16.2 Occupant Loading.

**16.2.1** The event coordinator shall ensure that the number of occupants admitted to the building is monitored and controlled so that the occupant load does not exceed the capacity of the means of egress, for the number of exits required by the applicable code.

**16.2.2** Orderly circulation of guests shall be maintained when special events are planned for large groups.

### 16.3 Means of Egress.

**16.3.1** Exits, access to exits, and all other evacuation capabilities shall be maintained.

**16.3.2** Tables, plants, stages, or other temporary fixtures shall not visually or physically obstruct an exit, exit sign, or exit access, or reduce the width of an exit passage.

**16.3.3** Prior to a performance or event, staff (especially temporary or part-time staff), contractor personnel, attendees, and participants shall be notified of the following:

- (1) How fire alarms are annunciated (i.e., audibly, visually, by voice communication, or a combination of these methods)
- (2) Locations of exit routes, exits, and assembly points
- (3) How to safely evacuate the area

**16.3.4** Key staff, including event coordinators, volunteers, and security, shall be familiar with exit routes and shall ensure that exits are obvious, operable, and not blocked or restricted in any way.

**16.3.5** Upon activation of the fire alarm, occupants shall be evacuated from the building according to the egress plan.

**16.4 Commercial Cooking and Food Service Operations.** Cooking and food warming shall be in accordance with Section 11.10.

**16.5 Smoking.** Smoking shall be prohibited except as provided in Section 11.5.

### 16.6 Fireworks.

**16.6.1** Demonstrations of fireworks shall be held outside the building or structure and shall conform to *NFPA 1123*.

**16.6.2** Demonstrations of fireworks or other pyrotechnics before a proximate audience shall conform to *NFPA 1126*.

### 16.7 Combustibles.

**16.7.1** Tents and canopies shall comply with the applicable building code and fire code and shall be noncombustible or certified as having been treated with an approved fire-retardant coating.

**16.7.2** Temporary draperies, bunting, textiles, wood, and miscellaneous support and decorative materials used inside the building shall comply with 16.7.2.1 through 16.7.2.6, except as provided in Section 11.2.

**16.7.2.1** Furnishings or decorations of an explosive or highly flammable character shall not be used. [*101:10.3.4*]

**16.7.2.2** Fire-retardant coatings shall be maintained to retain the effectiveness of the treatment under service conditions encountered in actual use. [*101:10.3.5*]

**16.7.2.3** The authority having jurisdiction shall impose controls on the quantity and arrangement of combustible contents in assembly occupancies to provide an adequate level of safety to life from fire. [*101:12.7.4.2; 101:13.7.4.2*]

**▲ 16.7.2.4** Exposed foamed plastic materials and unprotected materials containing foamed plastic used for decorative purposes or stage scenery shall have a heat release rate not exceeding 100 kW where tested in accordance with one of the following:

- (1) ANSI/UL 1975, *Standard for Fire Tests for Foamed Plastics Used for Decorative Purposes*
- (2) *NFPA 289* using the 20 kW ignition source [*101:12.7.4.3; 101:13.7.4.3*]

**16.7.2.5** The requirement of 16.7.2.4 shall not apply to individual foamed plastic items and items containing foamed plastic where the foamed plastic does not exceed 1 lb (0.45 kg) in weight. [*101:12.7.4.4; 101:13.7.4.4*]

**16.7.2.6** Wood shall be fire-retardant treated and meet the requirements of *NFPA 703*.

### 16.8 Electrical Equipment.

**16.8.1** Electrical appliances and equipment, including temporary installations, shall be listed, and wiring shall comply with *NFPA 70*.

**16.8.2** Exposed electrical wiring and extension cords shall not be placed across travel or exit routes.

**16.8.3\*** A licensed or registered electrician shall verify that electrical circuits do not exceed their rated capacity.

### 16.9 Use of Historic Structures by Others.

**16.9.1** The governing body or a designated representative shall enforce the historic structure's fire prevention and security plans. They shall have the authority to stop work or other activities when the work or activities jeopardize the safety or security of the historic structure.

**16.9.2** The fire prevention and security plans described in 16.9.1 shall include, but shall not be limited to, all of the following:

- (1) Fire spread control systems
- (2) Fire protection systems
- (3) Electrical systems
- (4) Security systems
- (5) Housekeeping
- (6) Storage of flammable liquids and gases
- (7) Hot work and other sources of ignition

### Annex A Explanatory Material

*Annex A is not a part of the requirements of this NFPA document but is included for informational purposes only. This annex contains explanatory material, numbered to correspond with the applicable text paragraphs.*

**A.1.1.2** Collections within libraries, museums and places of worship should be evaluated and protected in accordance with NFPA 909.

**A.1.2** As an example, this code is intended to provide a level of protection that will assist in the following four main categories:

- (1) Protect the occupants, a group that is intended to include the staff and the visitors, as well as any outside contract agents who might work in the facility
- (2) Protect the contents of the structure
- (3) Protect the physical structure itself from the effects of an unwanted fire
- (4) Plan for resiliency

In all cases, the protection scheme derived is intended to minimize the intrusion on the historic fabric of the facility.

The U.S. Department of the Interior establishes a list of guidelines and criteria that are typically used by various entities to establish overall objectives for maintaining the fabric of an historic site or structure. (*See Annex N for additional information.*)

**A.1.5** A sample ordinance is provided in Annex M.

**A.3.2.1 Approved.** The National Fire Protection Association does not approve, inspect, or certify any installations, procedures, equipment, or materials; nor does it approve or evaluate testing laboratories. In determining the acceptability of installations, procedures, equipment, or materials, the authority having jurisdiction may base acceptance on compliance with NFPA or other appropriate standards. In the absence of such standards, said authority may require evidence of proper installation, procedure, or use. The authority having jurisdiction may also refer to the listings or labeling practices of an organization that is concerned with product evaluations and is thus in a position to determine compliance with appropriate standards for the current production of listed items.

**A.3.2.2 Authority Having Jurisdiction (AHJ).** The phrase “authority having jurisdiction,” or its acronym AHJ, is used in NFPA documents in a broad manner, since jurisdictions and approval agencies vary, as do their responsibilities. Where public safety is primary, the authority having jurisdiction may be a federal, state, local, or other regional department or individual such as a fire chief; fire marshal; chief of a fire prevention bureau, labor department, or health department; building official; electrical inspector; or others having statutory authority. For insurance purposes, an insurance inspection depart-

ment, rating bureau, or other insurance company representative may be the authority having jurisdiction. In many circumstances, the property owner or his or her designated agent assumes the role of the authority having jurisdiction; at government installations, the commanding officer or departmental official may be the authority having jurisdiction.

**A.3.2.3 Code.** The decision to designate a standard as a “code” is based on such factors as the size and scope of the document, its intended use and form of adoption, and whether it contains substantial enforcement and administrative provisions.

**A.3.2.5 Listed.** The means for identifying listed equipment may vary for each organization concerned with product evaluation; some organizations do not recognize equipment as listed unless it is also labeled. The authority having jurisdiction should utilize the system employed by the listing organization to identify a listed product.

**A.3.3.6 Atrium.** As defined in NFPA 92, a large-volume space is an uncomparted space, generally two or more stories in height, within which smoke from a fire either in the space or in a communicating space can move and accumulate without restriction. Atria and malls are examples of large-volume spaces.

**A.3.3.7.1 Fire Barrier.** A fire barrier, such as a wall or floor assembly, might be aligned vertically or horizontally.

**A.3.3.7.2 Smoke Barrier.** A smoke barrier, such as a wall, floor, or ceiling assembly, might be aligned vertically or horizontally. A smoke barrier might or might not have a fire resistance rating.

**A.3.3.9 Building Systems.** Building systems include all electrical power services; communication and security services; electrical control systems; HVAC systems; water, steam, wastewater, and drainpipes and services; fire suppression systems including water-based and non-water-based systems; oil and piped hydraulic and pneumatic systems.

**A.3.3.10 Buildings.** The term *building* is to be construed as if followed by the words “or portions thereof.” Each portion of a building that is separated from other portions by a noncombustible fire wall with a minimum 2-hour fire resistance rating can be considered to be a separate building.

**A.3.3.16 Conservation.** The four explicit functions of conservation are examination, documentation, preservation, and restoration. Examination is a procedure used to determine the nature, method of manufacture, or properties of materials and the causes of their deterioration. Documentation procedures record the condition of an object before, during, and after treatment and outline, in detail, treatment methods and materials used. Preservation is action taken to prevent, stop, or retard deterioration. The process includes both the stabilization of the condition of a work of art by conservation and the stabilization of the environment surrounding a work of art by preventative conservation methods to minimize the effects of agents of deterioration. Restoration is the reconstruction of missing parts in an effort to recreate the original appearance of a damaged work of art.

**A.3.3.18 Cultural Resource Properties.** Such properties include, but are not limited to, museums, libraries, historic structures, and places of worship.

**A.3.3.20 Design Specifications.** Design specifications include both hardware and human factors, such as the conditions produced by maintenance and training. For purposes of performance-based design, the design specifications of interest are those that affect the ability of the building to meet the stated goals and objectives. Additionally, these specifications should also include any special techniques or procedures that might be necessary to minimize intrusion into the historically significant portions of the building.

**A.3.3.21 Design Team.** The individuals responsible for the governance of the property are essential to this team. Establishing boundaries for the limits of the work or guiding discussions on prioritizing the areas or spaces to be preserved should be based on the significance of the property and needs of the governing body.

**A.3.3.27 Exposure Fire.** An exposure fire usually refers to a fire that starts outside a building, such as a wildlands fire or vehicle fire, and that, consequently, exposes the building to a fire. [101, 2018]

**A.3.3.28 Feature (Cultural Landscape).** Examples include a woodlot, hedge, lawn, specimen plant, allée, house, meadow or open field, fence, wall, earthwork, pond or pool, bollard, orchard, or agricultural terrace.

**A.3.3.32 Fire Model.** Due to the complex nature of the principles involved, models are often packaged as computer software. Attached to the fire models will be any relevant input data, assumptions, and limitations needed to properly implement the model.

**A.3.3.36 Fire Safety Manager.** In smaller organizations, this role is permitted to be combined with that of another position or appointment. In larger institutions, the person's responsibilities are permitted to include supervision of other fire protection staff. The authorized person is permitted to be an employee of the institution who has experience with generally accepted fire protection practices. Alternatively, cultural resource facilities or institutions are permitted to designate appropriate outside persons such as consulting fire protection engineers, fire service personnel, insurance company loss control representatives, local code officials, or other individuals with similar fire protection credentials.

**A.3.3.42 Hazardous Area.** Hazardous areas include those areas used for the storage or use of combustibles or flammables; toxic, noxious, or corrosive materials; or heat-producing appliances. [5000, 2018]

**A.3.3.43 Historic Building.** Designation could be in an official existing or future national, regional, or local historic register, listing, or inventory. Properties that meet the criteria for eligibility should be treated as eligible. Properties meeting the criteria for eligibility include buildings in a historic district that are not architecturally distinguished, but whose scale, proportions, materials, and details are consistent with the character of the district. This can also include iconic structures.

Iconic Structure—Edifice or object of such global cultural significance that its preservation is of utmost importance to maintain the identity and economy of the area where it is located.

Many historical structures and sites have a global, national, or local significance that goes beyond traditional preservation. For example, UNESCO World Heritage Sites need a higher

level of protection than most historic buildings addressed by this code.

Such iconic sites should have a fire protection program with appropriate emphasis on the following:

- (1) Increased administrative oversight of fire risk assessment, fire hazard abatement, and fire emergency pre-planning
- (2) Enhanced fire prevention limitation of combustibles and ignition sources
- (3) Optimal built-in fire containment and control including structural fire barriers, fire detection and alarm, automatic fire suppression systems, and smoke management
- (4) Greater emergency response in the event of a fire, including suppression, damage-limitation, and salvage

Each facility will need to identify the potential of a fire loss and the relationship to other threats.

**A.3.3.58 Limited-Combustible Material.** Materials subject to increase in combustibility or flame spread index beyond the limits herein established through the effects of age, moisture, or other atmospheric conditions are considered combustible.

**A.3.3.64 Objective.** Objectives define a series of actions necessary to make the achievement of a goal much more likely. Objectives are stated in more specific terms than goals and are measured on a more quantitative, rather than qualitative, basis.

**A.3.3.68 Performance-Based Design Approach.** This process allows performance-based documents to be implemented and ensures that their goals are met.

**A.3.3.76 Proposed Design.** The design team might develop a number of trial designs that are evaluated to determine if they meet the specified performance criteria. One or more of the trial designs will be selected from those that meet the performance criteria, for submission to the AHJ as the proposed design.

The proposed design is not necessarily limited to fire protection systems and building features; it also includes any component of the proposed design that is installed, established, or maintained for the purpose of life safety, without which the proposed design could fail to achieve specified performance criteria. In addition, the impact of the proposed design on the historic fabric and character of the building needs to be evaluated. As such, the proposed design often includes emergency procedures, management operational systems, and organizational structures that are necessary to meet the performance criteria specified for the proposed design.

**A.3.3.78 Protection.** In its broadest sense, protection also includes long-term efforts to deter or prevent vandalism, theft, arson, and other criminal acts against historic resources.

**A.3.3.82 Resiliency.** Resiliency can also be considered the adaptive capacity of an organization in a complex and changing environment, or the ability of an organization to manage disruptive related risk. Further, it might be an organization's ability to prevent or resist being affected by an event, the ability to return to an acceptable level of performance in an acceptable period of time after being affected by an event, or the capability of a system to maintain its functions and structure in the face of internal and external change.

**A.3.3.86.2 Fire Scenario.** A fire scenario defines the conditions under which a proposed design is expected to meet the fire safety goals. Factors typically include fuel characteristics,

ignition sources, ventilation, building characteristics, and occupant locations and characteristics. *Fire scenario* includes more than the characteristics of the fire itself, but it excludes design specifications and any characteristics that do not vary from one fire to another; the latter are called *assumptions*. The term *fire scenario* is used here to mean only those specifications required to calculate the fire's development and effects, but in other contexts, the term can be used to mean both the initial specifications and the subsequent development and effects (i.e., a complete description of fire from conditions prior to ignition to conditions following extinguishment).

**A.3.3.92 Special Event.** Special events are intended to include events that introduce unusual hazards to the facility. Special events include, but are not limited to, receptions, dinners, private viewings, pyrotechnic displays, exhibits, or fairs.

**A.3.3.94.3 Sprinkler System.** As applied to the definition of a sprinkler system, each system riser serving a portion of a single floor of a facility or where individual floor control valves are used in a multistory building should be considered a separate sprinkler system. Multiple sprinkler systems can be supplied by a common supply main. [13, 2019]

**A.4.3** The primary difference between goals and objectives is that objectives are more specific to the problem being solved or the document being developed. The same goals can be applied to most NFPA documents, while objectives are intended to reflect the nature and intent of a particular document in question.

**A.4.3.2.1** Substantial renovation or modification to an existing historic building will often be a difficult challenge. Additional means to minimize alteration of the historic structure should be considered. Such means would include the following:

- (1) Presence of a limited amount of combustible material
- (2) Installation of active fire protection systems
- (3) Reliance on staff members
- (4) Any combination thereof

**A.4.3.2.4** Where adaptive reuse of a building is being undertaken, there may be fewer changes required in the egress system, fire protection equipment, and other features, for certain new occupancies than for others. Depending upon the significance of various elements to the historic character of the building, life safety and historic preservation goals may be more easily achieved with some new uses than with others.

**A.7.1** This code gives both prescriptive-based and performance-based approaches to achieving its fundamental objectives. Equivalency is also included as an integral concept to achieve compliance. The code, therefore, provides a specific process chapter to guide the user in the code's application and to reduce possible confusion in the reading and implementation of the code.

**A.7.2** A project team should be interdisciplinary in nature, representing both safety and preservation concerns. Early consultation and coordination at each step of the process is highly desirable and strongly recommended. While every effort should be made to create an interdisciplinary team of players, the code recognizes that there will be times when such a diversity of members is not possible. The code, therefore, urges but does not require any particular membership of the team. Participants on the team can include the following:

- (1) Design professionals
- (2) Fire protection consultant

- (3) AHJs, including, but not limited to:
  - (a) Preservation officer or review agency
  - (b) Fire code official
  - (c) Building code official or permitting authority
  - (d) Insurance company representative/broker
- (4) Representative contractor
- (5) Building manager
- (6) Fire safety manager
- (7) Building occupants
- (8) Building owner

**A.7.3** The assessment is intended to evaluate the relevant historic elements, spaces, and features and the relevant fire safety issues in the building or structure. The extent and depth of the assessment might vary, depending upon the historic significance of the building and its component elements, the size and complexity of the building, changes of occupancy classification, and other factors as appropriate.

**A.7.3.1** Fire risk indexing is an accepted approach that identifies the relative importance of fire safety features. The process consists of a multi-attribute decision analysis for quantitatively balancing variables of risk, hazard, and safety to achieve an acceptable level of fire safety. Fire risk indexing is a systemic approach to equivalency that considers the building in its entirety and produces a calculated value to identify the degree of compliance with the intent of a prescriptive code. It highlights and measures relative weakness of areas of deficiency and identifies areas of strength that can be used to offset deficiencies. As such, it is an efficient approach to evaluation of code compliance and can be used to identify the need for adaptation of prescriptive requirements or implementation of a performance-based option.

**A.7.3.1.2** Required exterior modifications or additions should be located on the less visible and least significant elevations in order to keep the impact on the historic character to a minimum. Character-defining features include, but are not limited to, sheathing or facade materials, roofing materials, chimneys, skylights, cornices, windows and doors, and porches and railings.

**A.7.3.1.3** The building survey should establish important characteristics of the building organization, building type, style, period of construction, or historic function. The building survey should review significant spaces to establish rooms or other interior locations that are typical of the building type or style or are associated with specific persons or events.

**A.7.3.1.6** Character-defining features and finishes include, but are not limited to, distinctive architectural details, wainscoting, parquet flooring, picture molding, mantels, ceiling medallions, built-in bookshelves and cabinets, crown molding, and arches, as well as simpler, more utilitarian features, such as plain windows and doors and associated trim.

**A.7.3.2** Examples of methods used to determine historical significance can include the General Services Administration Guidelines for Zoning for Historic Properties and the Secretary of the Interior Standards.

Modifications or additions should be located at less visible, secondary areas in a manner that minimizes visual impact and damage to historic materials. Modifications and additions should be permitted at primary areas when it is not practicable to utilize secondary areas.

**Δ A.7.3.3.1.3** Both NFPA 101 and NFPA 914 recognize that fully complying with the requirements of any code or standard might not be practicable in a historic building or structure. NFPA 914 is predicated upon this approach. In addition, NFPA 101 also recognizes this potential problem.

The following text is from the 2018 edition of NFPA 101:

The provisions of this *Code* shall be permitted to be modified by the authority having jurisdiction for buildings or structures identified and classified as historic buildings or structures where it is evident that a reasonable degree of safety is provided. [101:4.6.4.2]

In existing buildings, it is not always practical to strictly apply the provisions of this *Code*. Physical limitations can cause the need for disproportionate effort or expense with little increase in life safety. In such cases, the authority having jurisdiction needs to be satisfied that reasonable life safety is ensured. [101:A.4.6.5]

In existing buildings, it is intended that any condition that represents a serious threat to life be mitigated by the application of appropriate safeguards. It is not intended to require modifications for conditions that do not represent a significant threat to life, even though such conditions are not literally in compliance with the *Code*. [101:A.4.6.5]

An example of what is intended by 4.6.5 [of NFPA 101] would be a historic ornamental guardrail baluster with spacing that does not comply with the 4 in. (100 mm) requirement. Because reducing the spacing would have minimal impact on life safety but could damage the historic character of the guardrail, the existing spacing might be approved by the authority having jurisdiction. [101:A.4.6.5]

**A.7.3.3.4** The building survey should be evaluated in accordance with the means of egress requirements of NFPA 101 or other applicable codes.

**A.7.3.4.1** See A.7.3.1.

**A.7.3.4.2** The following documents have an established record of meeting code objectives through a fire risk indexing approach:

- (1) Chapters 4 through 9 of the 2019 edition of NFPA 101A
- (2) *Wisconsin Administrative Code*, Subchapter IV, Building Evaluation Method, Chapter Comm. 70–Historic Buildings, 2005
- (3) Chapter 12, “Compliance Alternatives,” International Existing Building Code, 2003 edition

**A.7.5.1** The selection of the method of application of the code could result from a consideration of the following:

- (1) Extent of deviation of the building from the prescriptive code
- (2) Difficulty in providing remedies to the prescriptive code
- (3) Historic significance of features that would be compromised by meeting the prescriptive code

The relative cost of the performance-based and prescriptive-based approaches could also require consideration, as this information might affect the financial means of the building owner to provide code compliance in the building.

The option appraisal and selection portion of the code can function as a tool to assist in selection of a prescriptive-based

and performance-based application. A building need not meet both sets of requirements.

**A.8.1.1** The three approaches to compliance with prescriptive requirements, alternatives, equivalencies, and modifications are in order of their legal certitude. Therefore, they should be considered in this order to minimize the need for lengthy negotiations or variance hearings. However, early conversations among interested parties can establish an acceptable level of compliance for a particular case.

**A.8.1.1.2** Compliance with prescriptive requirements of applicable codes does not always require the construction or installation of intrusive elements or features that might negatively impact the historic fabric of the subject building.

**A.8.1.2** Alternatives refer to options that are explicitly stated in the requirements of the prevailing code. These alternatives are often incorporated into exceptions to specific provisions. A careful reading of the prevailing code could reveal more acceptable options to the standard compliance requirements. Particular attention to alternatives should be given where jurisdictions have adopted model codes but have made exceptions for existing or historic buildings. See Annex F for examples of compliance alternatives.

**A.8.1.3** Equivalency refers to alternative fire safety measures that can be established to provide a level of safety that is equivalent to the prevailing code; for example, installing fire detection and suppression that is not legally required in place of structurally altering the interior of a building. A less common alternative is the compensation for a code deficiency by operational features; for example, compensating for a dead-end corridor with occupant training.

Equivalency is a common code clause that allows other means of compliance if those means can be demonstrated and documented. There are many ways to address the issue of documenting equivalency, such as precedents, ad hoc equivalency, fire risk indexing, and component performance evaluation. These ways are explained in order of complexity.

*Precedents* are continually established in the regulation of fire safety for historic buildings. They represent acceptable alternatives that have not been formally incorporated into a regulatory document. The annexes of this document are a unique source of identifying many of these precedents. Other precedents might be available locally.

*Ad hoc equivalency* can be established by employing subjective logic. One qualitative approach used to evaluate alternative arrangements for equivalent safety from fire is NFPA 550. The tree is a logic diagram that represents all possible means of meeting fire safety objectives. By increasing fire safety measures on one branch of the tree, one can offset a lack of required measures on another branch, thus establishing an arrangement of equivalent fire protection.

Performance-based fire safety can also be approached on a component basis rather than on a systemic basis. Some fire safety components already have a form of performance criteria, such as fire resistance. Component performance can also be evaluated on a more ad hoc basis through the use of equivalency clauses in building codes. Codifying more component performance criteria can provide solutions for many problems; for example, establishing measurable fire safety objectives for doors, stairs, fire escapes, dead ends, exit signs, and so forth, would help when dealing with these issues in historic buildings.

**A.8.1.3.2** Any departure from the prescriptive code should be shown through adequate documentation to provide an equivalent level of protection. The extent of documentation/analysis required to demonstrate equivalency shall be commensurate with the complexity of the issue.

Equivalent solutions rely on the prescriptive code or standard as a departure point from strict compliance. Identification is made of the areas where the building deviates from the prescriptive requirement, and an equivalent solution is considered for any nonconforming issue. Equivalent solutions continue to work within the framework of the prescriptive code and justify departures from the prescriptive requirements, either individually or collectively, with an alternative acceptable to the AHJs. The code provides extensive annex material in an effort to provide a stronger framework of information to AHJs as they form decisions on proposed equivalent alternatives. The annex material also encourages the identification of still more resources to continue to support AHJs in their role of judging proposed alternatives. Maximum flexibility within the confines of equivalent safety is encouraged at all times.

It is the intent of this code that liberal use be made of the annex material and references in the code as a basis for establishing equivalency. These and other materials, which are commonly consulted to provide documentation for performance-based design approaches, also provide strong guidance and support for equivalency solutions. Other materials and information to be considered can include the identification of precedents and research findings.

The annex material, as well as the referenced documents cited throughout this code can be used as sources of information to evaluate design alternatives. The application of specific information from these or other sources must be demonstrated as sound through the performance-based approach requirements described in Chapter 9 of this code. The annexes and referenced documents are not intended to be exclusive sources of information. Any source of information that can be demonstrated to be credible and valuable to the evaluation of the proposed design can be used in conjunction with this code.

**A.8.1.4** In historic buildings, it is not always practical to strictly apply the provisions of the prevailing code. Physical limitations can require disproportionate effort or expense with little increase in life safety. In such cases, the AHJ should be satisfied that reasonable life safety is ensured.

In historic buildings it is intended that any condition that represents a serious threat to life be mitigated by application of appropriate safeguards. It is not intended to require modifications for conditions that do not represent a significant threat to life, even though such conditions are not literally in compliance with the prevailing code. Among the means of reasonably modifying prescriptive requirements are tolerances and waivers.

Tolerances allow for flexibility by relaxing the many “magic numbers” in code requirements; for example, 50 people, 32 in. wide, 1-hour fire resistance, and so forth. Reasonable dimensional tolerances should be permitted in applying prescriptive requirements to historic buildings. A 10 percent to 20 percent tolerance in prescriptive criteria may be reasonable if it allows historic preservation objectives to be achieved. In legal jargon, such tolerances are referred to as *de minimis*; that is, they are considered insignificant with respect to the overall safety of the building. Tolerance in strict application of installation stand-

ards can also be appropriate; for example, allowing a particularly sensitive room to remain unprotected in an otherwise fully sprinklered building.

*Waivers* can be another form of *de minimis* code application. Waivers can be appropriate where applying a code requirement in a historic building is not reasonable; for example, a requirement that all exit doors in historic buildings need to swing outward could be unreasonable for some situations.

**A.8.2** The subjects discussed in Section 8.2 are intended to be a partial listing of safety features or beneficial attributes of a historic structure that could help compensate or offset one or more prescriptive code deficiencies. These provisions are not mandatory but should be identified when making an argument for alternative approaches, equivalencies, or modifications to the prescriptive code requirement.

**A.8.2(6)** Filling concealed spaces with inert materials, such as mineral wool insulation or similar fire-resistive materials, can further retard the spread of fire. Care should be taken to ensure that the introduction of fire barriers or fire stopping does not inadvertently result in a disturbance of the building’s microclimate by impeding air flow, which might result in the growth of mold or fungus.

**A.8.2(7)** The U.S. Department of Housing and Urban Development has developed the *Guideline on Fire Ratings of Archaic Materials and Assemblies* to identify approximate fire resistance qualities of older construction methods.

**A.8.2(8)** Fire detection systems that can discriminate or identify any number of characteristics of fire (e.g., presence of smoke, critical temperature rise, or infrared/ultraviolet radiation) are also considered to be a compensatory feature. The detection device that offers the fastest response with respect to the type of occupancy should be a primary consideration.

**A.9.1** Chapter 9 of this code provides requirements for the evaluation of a performance-based life safety and fire protection design. The evaluation process is summarized in Annex L.

**A.9.1.3** Qualifications should include experience, education, and credentials that demonstrate knowledgeable and responsible use of applicable models and methods.

**A.9.1.4** A third-party reviewer is a person or group of persons chosen by the AHJ to review proposed performance-based designs. For more information on peer review of fire protection designs, see the *SFPE Guidelines for Peer Review in the Fire Protection Design Process*.

**A.9.1.7** Continued compliance with the goals and objectives of the code involves many things. The building construction — including openings, interior finish, and fire- and smoke-resistive construction — and the building and fire protection systems should retain at least the same level of performance as provided for the original design parameters. Performance designs that include such features related to management operational systems should include specific instructions related to features. The use and occupancy should not change to the degree that assumptions made about the occupant characteristics, combustibility of furnishings, and existence of trained personnel are no longer valid. In addition, actions provided by other personnel, such as event staff or emergency responders, should not be diminished below the documented assumed levels. Also, actions needed to maintain reliability of systems at the anticipated level should meet the initial design criteria.



**A.9.2.2.1** Annex H identifies methods that can be used to develop means by which occupants' exposure to untenable conditions can be addressed.

**▲ A.9.2.2.2** This evaluation should consider the use of multiple or redundant systems, features, and techniques. Objects or building features, if any, that are deemed acceptable to lose to a fire should be evaluated and determined. The following could be potential areas of evaluation for the design team:

- (1) Set detailed performance criteria that would ensure that selected rooms or spaces are protected from flame, heat, or smoke. The *SFPE Engineering Guide to Performance-Based Fire Protection* describes a process of establishing damage limits. The *SFPE Handbook of Fire Protection Engineering* also contains relevant information on thermal damage to various building materials and information on corrosivity of smoke.
- (2) Demonstrate for each design fire scenario and the design specifications, conditions, and assumptions, that each room or area will be fully isolated from the fire before the smoke and thermal layer in the room descend to a level where irreversible damage can occur.
- (3) Demonstrate for each design fire scenario and the design specifications and assumptions, that the smoke and thermal layer will not descend to a level where irreversible damage can occur in any room. The advantage of this procedure is that it conservatively requires that no historically significant item need be exposed to fire effects for the demonstration, regardless of where that room or space is located.
- (4) Demonstrate for each design fire scenario and the design specifications and assumptions, that no fire effects will reach any room or space beyond the room of origin. An advantage of this procedure is that it also removes the need for some of the modeling of fire effects, because it is not necessary to model the filling of rooms, only the spread of fire effects to those rooms. This is even more conservative and simpler than the procedures in A.9.2.2.2(2) and A.9.2.2.2(3), because it does not allow any fire effects into any rooms with historically significant features.

**A.9.3.1** This requirement applies both to systems and features, including management operational systems required by the code, that reference applicable standards, and to additional systems or features included in the design at the discretion of the design team. The referenced standards are hereby expected to state maintenance, testing, and other requirements needed to provide positive assurance of an acceptable level of reliability. The referenced standards themselves can be prescriptive- or performance-based.

**A.9.3.2** The design should comply with the following requirements for select components in the means of egress. The following components are taken from NFPA 101:

- (1) Changes in level in means of egress
- (2) Guards
- (3) Doors
- (4) Stairs
- (5) Ramps
- (6) Fire escape ladders
- (7) Alternating tread devices
- (8) Capacity of means of egress
- (9) Impediments to egress
- (10) Illumination of means of egress

- (11) Emergency lighting
- (12) Marking of means of egress

**A.9.4.1** The design specifications and other conditions form the input to evaluation of proposed designs (*see Section 9.6*). Where a specification or condition is not known, a reasonable estimation can be made. However, the design team should take steps to ensure that the estimation is valid during the life of the building. Any estimations need to be documented. (*See Section 9.8.*)

**A.9.4.3** These characteristics should extend beyond the normal analysis of building construction features. Elements such as the type of construction, construction technique, use of special materials, as well as any unusual design features in the building, should also be explicitly identified.

**A.9.4.4** Systems addressed by this requirement include automatic fire suppression systems and fire alarm systems. Performance issues that need to be documented might include response time indexes, discharge densities, and distribution patterns. Calculations should not include an unlimited supply of extinguishing agent if only a limited supply is provided in the actual structure or building.

**A.9.4.5.1.1** Examples of design features that might be incorporated to modify expected occupant characteristics include training, use of staff to assist with notification and movement, or type of notification appliance used. For more information on occupant characteristics, see the *SFPE Engineering Guide to Human Behavior in Fire*.

**A.9.4.5.2** The four basic characteristics — sensibility, reactivity, mobility, and susceptibility — comprise a minimal, exhaustive set of mutually exclusive, performance characteristics of people in buildings that can affect a fire safety system's ability to meet life safety objectives. The characteristics are briefly described as follows:

- (1) *Sensibility* (to physical cues) is the ability to sense the sounding of an alarm. It can also include discernment and discrimination of visual and olfactory cues in addition to auditory emanations from the fire itself.
- (2) *Reactivity* is the ability to interpret cues correctly and to take appropriate action. Reactivity can be a function of cognitive capacity, speed of instinctive reaction, or group dynamics. Occupants might need to understand how relying on familiarity with the premises could influence wayfinding and increased likelihood of a wrong decision.
- (3) *Mobility* (speed of movement) is determined by individual capabilities as well as by crowding phenomena such as arching at doorways.
- (4) *Susceptibility* (to products of combustion). Metabolism, lung capacity, pulmonary disease, allergies, or other physical limitations can affect survivability in a fire environment.

In application, as with the use of computer evacuation models, assumptions can address a larger number of factors that are components of the basic performance characteristics described in Table A.9.4.5.2.

**A.9.4.5.4** The number of people expected to be contained in a room or area should be based on the occupant load factor specified in NFPA 101 or other approved sources.

**△ Table A.9.4.5.2 Performance Characteristics**

Characteristics	Description
Alertness	Awake/asleep, can depend on time of day
Responsiveness	Ability to sense cues and react
Commitment	Degree to which occupant is committed to an activity underway before the alarm
Focal point	Point to which an occupant's attention is focused (e.g., to front of classroom, stage, or server in business environment)
Physical and mental capabilities	Can affect ability to sense, respond, and react to cues; can be related to age or disability
Role	Can determine whether occupant will lead or follow others
Familiarity	Can depend on time spent in building or participation in emergency training
Social affiliation	Extent to which an occupant acts/reacts as an individual or as a member of a group
Condition	Over the course of the fire, the effects — both physiological and psychological — of the fire and its combustion products on each occupant

**A.9.4.5.5** For example, in museums, staff characteristics such as number, location, quality, and frequency of training should be considered.

**A.9.4.7** Design proposals need to state explicitly any design specifications or estimations regarding building fire safety plans, inspection programs, or other ongoing programs, whose performance is necessary for the building when occupied and operational or when closed after hours, to meet the stated goals and objectives.

Programs of interest include any maintenance, training, labeling, or certification programs required to assure operational status or reliability in building systems or features.

**A.9.4.9** This requirement includes assumptions about the interrelations between the performance of building elements and systems, occupant behavior, or emergency response actions that conflict with each other. For each fire scenario, care needs to be taken to assure that conflicts in actions do not occur. Typical conflicts could include the following and similar assumptions:

- (1) A fire door will remain closed during the fire event to contain smoke, while this same door is used by occupants during egress from the area.
- (2) A room door to a historically significant space is closed at all times, yet the door is normally open for public viewing.
- (3) Fire apparatus will arrive immediately from a distant location to charge fire department connections to provide water.

For example, an assumption that compartmentation blocking the passage of fire and smoke will be maintained at the door from a historically significant space or to a stairwell cannot be paired with an assumption that evacuation through that door will extend over many minutes.

**A.9.4.10** This requirement includes provisions that are in excess of basic requirements covered by referenced codes and

standards, typical design requirements, and operating procedures. It includes provisions such as more frequent periodic testing and maintenance to increase the reliability of fire protection systems, redundant systems to increase reliability, on-site staff assistance to enhance detection of fires and aid in fire response procedures, staff training, availability and performance of emergency response personnel, and other factors.

**△ A.9.5.1** Design fire scenarios define the challenge a building is expected to withstand. They also need to define the threat to the historically significant features or attributes of the building. Design fire scenarios capture and limit value judgments on the type and severity of the fire challenge to which a proposed fire safety system needs to respond. The fire safety system includes any or all of the following aspects of the proposed design that are intended to mitigate the effects of a fire:

- (1) Egress system
- (2) Automatic detection and suppression
- (3) Barriers
- (4) Staff training
- (5) Placement of manual extinguishers

Design fire scenarios come from two sources — those that are specified in paragraphs 9.5.3.2 through 9.5.3.9, and those that are developed by the design team based on the unique characteristics of the building as required by 9.5.2. In most, if not all cases, more than one design fire scenario should be developed to meet the requirements of 9.5.2.

Once the set of design fire scenarios is established — both those specified by 9.5.3.2 through 9.5.3.9 and those that are developed as required by 9.5.2 — they must be quantified into a format that can be used for the evaluation of proposed designs. The *SFPE Engineering Guide to Performance-Based Fire Protection* outlines a process and identifies tools and references that can be used at each step of this process.

**A.9.5.2** The protection systems and features used to meet the challenge of the design fire scenario should be typical of, and

consistent with, those used for similar areas of the building. The systems and features should not be designed to be more effective in the building area addressed than in similar areas not included in the design and therefore not explicitly evaluated.

**A.9.5.3** It is desirable to run a wide variety of fire scenarios to evaluate the complete fire protection and life safety capabilities of the building or structure. Fire scenarios should not be limited to a single or a couple of “worst case” fire scenarios.

The descriptive terms used to indicate the rate of fire growth for the scenarios are intended to be generic. Use of *t*-squared fires is not required for any scenario.

**A.9.5.3.2** An example of a Design Fire Scenario 1 for a historic building would involve a public museum or library. A large concentration of occupants could be present. A significant element or feature could be immediately threatened by a fire. This scenario is a cursory example, in that much of the explicitly required information in 9.5.3.2 can be determined from the information provided in the example. Note that it is usually necessary to consider more than one scenario to capture the features and conditions typical of an occupancy.

**A.9.5.3.3** Examples of Design Fire Scenario 2 are the following: a fire involving ignition of gasoline as an accelerant in a means of egress, or in renovation materials or other fuel configurations that can cause an ultrafast-developing fire. The means of egress chosen is the doorway with the largest egress capacity among doorways normally used in the ordinary operation of the building. The baseline occupant characteristics for the property are assumed. Such spaces can also contain building materials or features that are historically significant. At ignition, doors are assumed to be open throughout the building.

**A.9.5.3.4** An example of a Design Fire Scenario 3 is a fire in a storage or collections room that is adjacent to the largest occupiable room in the building, or that is adjacent to the room or area with the most historically significant content. The contents of the room of fire origin are specified to provide the largest fuel load and the most rapid growth in fire severity and to be consistent with the normal use of the room. The adjacent occupiable room is assumed to be filled to capacity with occupants. Occupants are assumed to be somewhat impaired in whatever form is most consistent with the intended use of the building. The room contains contents that are vulnerable to minor quantities of heat or smoke. At ignition, doors from both rooms are assumed to be open. Depending upon the design, doorways may connect the two rooms, or they may connect via a common hallway or corridor.

For purposes of this scenario, an occupiable room is one that contains people (i.e., a location within a building where people are typically found).

**A.9.5.3.5** An example of a Design Fire Scenario 4 is a fire originating in a concealed wall- or ceiling-space that is adjacent to a large occupied function room or a room or space containing a special collection, furniture, or works of art. Ignition involves concealed combustibles, including wire or cable insulation and thermal or acoustical insulation. The adjacent function room is assumed to be occupied to capacity. The baseline occupant and building characteristics for the property are assumed. At ignition, doors are assumed to be open throughout the building.

**A.9.5.3.6** An example of a Design Fire Scenario 5 is a cigarette fire in a trash can. The trash can is close enough to room

contents to ignite more substantial fuel sources but it is not close enough for any occupant to create an intimate-with-ignition situation or close enough to immediately endanger any of the historically significant spaces or objects. If the intended use of the property involves the potential for some occupants to be incapable of movement at any time, then the room of origin is chosen as the type of room likely to have such occupants, and it is filled to capacity with occupants in that condition. If the intended use of the property does not involve the potential for some occupants to be incapable of movement, then the room of origin is chosen to be an assembly or function area characteristic of the use of the property, and the trash can is placed so that it is shielded from suppression systems. At ignition, doors are assumed to be open throughout the building.

**A.9.5.3.7** An example of a Design Fire Scenario 6 is a fire originating in the largest fuel load of combustibles possible in normal operation in a function or assembly room, or in a process/manufacturing area, characteristic of the normal operation of the property. The configuration, type, and geometry of the combustibles are chosen so as to produce the most rapid and severe fire growth or smoke generation consistent with the normal operation of the property. The baseline occupant characteristics of the property are assumed. At ignition, doors are assumed to be closed throughout the building.

This category includes everything from a big couch fire in a small dwelling, to a rack fire in combustible liquids stock in a big box retail store.

**A.9.5.3.8** An example of a Design Fire Scenario 7 is an exposure fire. The initiating fire is the closest and most severe fire possible, consistent with the placement and type of adjacent properties and the placement of plants and combustible adornments on the property. The baseline occupant characteristics of the property are assumed.

This category includes wildlands/urban interface fires, exposure from fires originating in adjacent structures, and exterior wood shingle problems, where applicable.

**A.9.5.3.9** Design Fire Scenario 8 addresses a set of conditions with a typical fire originating in the building with any one passive or active fire protection system or feature being ineffective. Examples in this category include unprotected openings between floors or between fire walls or fire barrier walls, rated fire doors that fail to close automatically or are blocked open, sprinkler system water supply shutoff, non-operative fire alarm system, smoke management system not operational, or automatic smoke dampers blocked open. This scenario should represent a reasonable challenge to the other building features provided by the design and presumed to be available.

The concept of a fire originating in ordinary combustibles is intentionally selected for this event. This fire, although presenting a realistic challenge to the building and the associated building systems, does not represent the worst case scenario or the most challenging fire event for the building.

Examples of fires originating in ordinary combustibles include the following:

- (1) *Corridor of a Historic Museum.* Staff is assumed not to close any exhibit space or room doors upon detection of fire. The baseline occupant characteristics of the property are assumed, and the areas or viewing rooms off the corridor are assumed to be filled to capacity with visitors. At igni-

tion, all such doors in the area are not equipped with self-closing devices and are assumed to be open throughout the smoke or fire compartment.

- (2) *Large Assembly Room or Area in the Interior of the Building.* The automatic suppression systems are assumed to be out of operation. The baseline occupant characteristics of the property are assumed, and the room of fire origin is assumed to be filled to capacity. At ignition, doors are assumed to be closed throughout the building. A specific or rare collection piece is located in the room of fire origin.
- (3) *Unoccupied Small Function Room Adjacent to a Large Assembly Room or Area in the Interior of the Building.* The automatic detection systems are assumed to be out of operation. The baseline occupant characteristics of the property are assumed; the room of fire origin is assumed to be unoccupied, and the assembly room is assumed to be filled to capacity. At ignition, doors are assumed to be closed throughout the building. The room or space is of particular historical significance and is vulnerable to potential damage from an undetected fire.

**A.9.5.3.9.2** The exception is applied to each active or passive fire protection system individually and requires two different types of information to be developed by analysis and approved by the AHJ. System reliability is to be analyzed and accepted. Design performance in the absence of the system is also to be analyzed and accepted, but acceptable performance need not mean fully meeting the stated goals and objectives. It could be impossible for a performance design to meet fully the goals and objectives with the key fire protection system unavailable, and yet no system is totally reliable. The AHJ will determine what level of performance, possibly short of the stated goals and objectives, is acceptable, given the very low probability (i.e., the system's unreliability probability) that this situation will occur.

**Δ A.9.6.1** The *SFPE Engineering Guide to Performance-Based Fire Protection* outlines a process for evaluating whether trial designs meet the performance criteria during the design fire scenarios.

Procedures described in Sections 9.2 and 9.4 identify required design fire scenarios within which a proposed fire safety design needs to perform and the associated untenable conditions that need to be avoided in order to maintain life safety. Additionally, these procedures should be used to establish the level of tolerance that specific contents, building features, or both, can sustain without incurring irreparable damage. Annex I discusses methods that form the link from the scenarios and criteria to the goals and objectives.

**Δ A.9.6.3.3** Procedures used to develop required input data need to preserve the intended conservatism of all scenarios and assumptions. Conservatism is only one means to address the uncertainty inherent in calculations and does not remove the need to consider safety factors, sensitivity analysis, and other methods of dealing with uncertainty. The *SFPE Engineering Guide to Performance-Based Fire Protection* outlines a process for identifying and treating uncertainty.

**A.9.6.4** An assessment method translates input data, which can be test specifications, parameters or variables for modeling, or other data, into output data that is measured against the performance criteria. Computer-based fire models should be evaluated for their predictive capability in accordance with ASTM E1355, *Standard Guide for Evaluating the Predictive Capability of Deterministic Fire Models*.

**A.9.7** See Annex L for additional information on sensitivity and uncertainty analysis and safety factors.

**Δ A.9.8.1** The *SFPE Engineering Guide to Performance-Based Fire Protection* describes the documentation that should be provided for a performance-based design.

Proper documentation of a performance-based design is critical to the design acceptance and construction. Proper documentation also assures that all parties involved understand what is necessary for the design implementation, maintenance, and continuity of the fire protection design. If attention to details is maintained in the documentation, there should be little dispute during approval, construction, startup, and use.

Poor documentation could result in rejection of an otherwise good design, poor implementation of the design, or inadequate system maintenance and reliability; and it would provide an incomplete record for future changes or if the design were forensically tested.

**A.9.8.2** The sources, methodologies, and data used in performance-based designs should be based on technical references that are widely accepted and utilized by the appropriate professions and professional groups. This acceptance is often based on documents that are developed, reviewed, and validated under one of the following processes:

- (1) Standards developed under an open consensus process conducted by recognized professional societies, codes or standards organizations, or governmental bodies
- (2) Technical references that are subject to a peer review process and are published in widely recognized peer-reviewed journals, conference reports, or other publications
- (3) Resource publications such as the *SFPE Handbook of Fire Protection Engineering* that are widely recognized technical sources of information

The following factors are helpful in determining the acceptability of the individual method or source:

- (1) Extent of general acceptance in the relevant professional community. Indications of this acceptance include peer-reviewed publications, widespread citations in the technical literature, and adoption by or within a consensus document.
- (2) Extent of documentation of the method, including the analytical method itself, assumptions, scope, limitations, data sources, and data reduction methods.
- (3) Extent of validation and analysis of uncertainties. These factors include a comparison of the overall method with experimental data to estimate error rates, as well as an analysis of the uncertainties of input data, uncertainties and limitations in the analytical method, and uncertainties in the associated performance criteria.
- (4) Extent to which the method is based on sound scientific principles.
- (5) Extent to which the proposed application is within the stated scope and limitations of the supporting information, including the range of applicability for which there is documented validation. Factors such as spatial dimensions, occupant characteristics, ambient conditions, and so forth, can limit valid applications.

In many cases, a method will be built from and include numerous component analyses. These component analyses

should be evaluated using the same factors that are applied to the overall method outlined in this chapter.

A method to address a specific fire safety issue within documented limitations or validation regimes might not exist. In such a case, sources and calculation methods can be used outside of their limitations, provided the design team recognizes the limitations and addresses the resulting implications.

The technical references and methodologies to be used in a performance-based design should be closely evaluated by the design team and the AHJ, and possibly by a third-party reviewer. The strength of the technical justification should be judged using criteria presented in A.9.8.2. This justification can be strengthened by the presence of data obtained from fire testing.

**A.9.8.11** Documentation for modeling should conform to ASTM E1472, *Standard Guide for Documenting Computer Software for Fire Models*, although most, if not all, models were originally developed before this standard was promulgated. For additional information on fire model verification and validation, see the *SFPE Guidelines for Substantiating a Fire Model for a Given Application*.

**A.9.10** Following the terrorist attacks of September 11, 2001, there has been a strong, multinational concern with the security of locations that are vulnerable to terrorism and potential terrorist attack. Unfortunately, security improvements have often been undertaken in the absence of comprehensive security planning. Decisions have been made without an adequate understanding of the actual risks or the significant adverse damages of those actions to the integrity of the very monuments society has chosen to commemorate and protect. Too often, expedient decisions have resulted in the introduction of incompatible features that compromise the character and integrity of the historic structure and landscape.

Historic access and traditional circulation patterns have been altered, urban settings destroyed, landscapes changed, and the public's perception of the historic "sense of place" sacrificed. It can be argued that such improvements have made some sites more vulnerable to terrorist attack. For example, a group of visitors queuing up at controlled entrances to many sites outside the protected perimeters of the historic property is a much easier target and more vulnerable to terrorist attack.

As an alternative to a formulaic approach to security, other property-specific security approaches that are visually integrated and designed to preserve the property's historic character should be explored. In some circumstances, security concerns can be substantially addressed through management operational systems, including increased staff training on observation and monitoring techniques and threat-level response and management. These actions require little or no alteration to the property.

Comprehensive security planning requires procedures for post-incident responses, such as the establishment of damage limitation team infrastructure, evacuation planning, implementation of the recovery or continuity plan, and better and quicker media response. Such procedures should make use of readily accessible social media and remote communications technology to promote efficient coordination among affected individuals.

The governing body or a designated representative should develop a close relationship with local law enforcement agen-

cies to familiarize them with the property and should ask them to include the property in patrol routes. Open lines of communication with the local police help provide information on crime and crime trends in the neighborhood or area. In addition, active participation in security and preservation associations is a means of sharing common security concerns and solutions.

**A.9.10.1** Those who conduct the SVA should have security or crime prevention qualifications, education, certification, or experience. They should be certified by a nationally recognized certification organization and should have experience working with historically significant structures and cultural landscapes

**A.9.10.2** Determination of the historic property's significance is fundamental to an SVA and its protection. Historic properties typically are classified as nationally, regionally, or locally significant, and significance often determines vulnerability to attack. For example, a site of national significance would be much more of a target than a small, local house museum.

An SVA should include the following steps:

- (1) A team of stakeholders should be formed.
- (2) The structures, landscapes, and facilities that are to be protected should be characterized.
- (3) Threats should be classified using a process that includes, but is not limited to, the following:
  - (a) Classification of critical assets
  - (b) Identification of potential targets
  - (c) Consequence analysis (e.g., effect of loss, including any potential off-site consequence)
  - (d) Identification of potential threats (e.g., identifying potential adversaries and what is known about them, information gained from consultation with local professional resources)
- (4) A threat vulnerability analysis should be conducted that identifies actual and potential threat scenarios and estimates their relative security risk level.
- (5) Countermeasures should be defined using information from steps 2 through 4, including characterization, threat, and vulnerability analysis.
- (6) The impact of the countermeasures on the property's historic character, integrity, and character-defining features should be assessed.
- (7) The relative security risk levels developed in step 4 should be reassessed, taking into account the countermeasures defined in step 5 and the assessment of their impact on the historic structure and its historic landscape from step 6. To reduce adverse impact on the historic structure and its historic landscape, additional security risk reduction measures should be implemented, or the risk reduction measures should be modified, or other countermeasures should be selected.
- (8) A resiliency or recovery plan should be developed based on the security vulnerability analysis.
- (9) Findings and recommendations should be documented, and the implementation of accepted recommendations should be tracked.

**A.9.10.2(1)** Vandalism is a crime of opportunity. Research indicates vandals look for places that offer the best opportunity for success, and they are strongly influenced by the look and feel of the structure they plan to vandalize. Consequently, if the exterior of a historic structure appears to reflect strong atten-

tion to security, vandals are likely to look for an easier opportunity. Consideration should be given to the following:

- (1) Physical security devices: Good locks, ironwork, and lighting all contribute to making a building appear secure.
- (2) Intrusion detection systems, including video surveillance systems and card reader access control systems.
- (3) Lighting that complies with NFPA 730 and *The Secretary of the Interior's Standards for the Treatment of Historic Properties with Guidelines for Preserving, Rehabilitating, Restoring, and Reconstructing Historic Buildings (The Secretary of the Interior's Standards)*.
- (4) Provisions for repairing damage from vandalism (e.g., broken windows) and removing graffiti as soon as possible. Experience shows that properties where damage from vandalism and graffiti is not quickly repaired attract more vandalism and graffiti.

**A.9.11.1** An effective security program depends on coordinated development and implementation of a security plan. Security for a historic structure should be coordinated with preservation planning and the building's management for the historic property's use and operation as well as ongoing maintenance, repair, and alterations. Security considerations should be integral with the design planning for building rehabilitation and restoration.

The significance, location, occupancy, and use of the historic structure will determine how much and what type of protection it requires. At a rural residence, a presidential home, or a historic campus, the use of a perimeter fence allowing for the creation of stand-off distances and gates staffed by security is one method to control vehicle access. In urban areas, the use of passive barriers, such as subtle landscape modifications and engineered landscape features such as planters, benches, or suitably designed bollards, can create room for pedestrians to walk to buildings protected against vehicle bombs while preserving the historic landscape setting associated with the historic building. Building exteriors should be managed or adapted to eliminate hiding places for criminals. Alternatives to physical barriers should be explored where security risks can be addressed by other means, such as modifying vehicle access patterns to accomplish the security and preservation goals of the community while protecting the building and occupants from harm. Alternatives to physical modifications include greater reliance on trained staff (management operational systems), observation and monitoring, threat-level management, and management and reversible responses.

Tools for improved detection of security threats include intrusion detection systems, video surveillance, security guards, greater reliance on trained staff, proprietary monitoring station alarm systems, metal detectors, and explosives detectors.

The security plan should include, but should not be limited to, the following:

- (1) Statement of purpose
- (2) Historic property policies and procedures
- (3) Description of the historic property
- (4) Security vulnerability assessment, including threat assessments and risks
- (5) Instructions for using the plan
- (6) Description of the features of protection
- (7) Historic property's security-related measures and procedures

- (8) Information needed to implement the security measures and procedures
- (9) List of the intended users of the plan
- (10) Plan distribution list
- (11) Location of the master copy
- (12) Organization for security operations
- (13) Processes and procedures for managing access to the historic structure or site and restricting access to critical infrastructure by establishing secure perimeters using physical, electronic, or other means. Where outside services (e.g., contractors, vendors, or other personnel) are used, management should ask the vendors' or contractors' management about their pre-employment screening and drug testing practices. Service providers could be treated either as employees or as visitors, depending on the contract and contact. For example, contract employees might be treated similarly to regular employees, whereas a package delivery service might be considered a visitor.
- (14) Provisions to limit vehicle entrance and exit portals to the minimum required for operation.
- (15) Provisions to secure exterior entrances, including, but not limited to, locking devices and protection against forcible entry (e.g., securing exterior hinge pins against removal on doors in security perimeters).
- (16) Provisions for security sensitive areas identified in the SVA; protection of work areas, communications, data infrastructure, and records storage areas against the admittance of unauthorized personnel; where appropriate, classification of nonpublic areas as controlled or restricted, including, but not limited to, kitchens, laundries, mechanical areas and utility connections, electrical distribution rooms, dwelling units, common spaces separated from designated public spaces, roofs, and staff restrooms.
- (17) Provisions for monitoring crime trends in and around the property by means of the following:
  - (a) Maintaining communication with local police and neighbors to keep informed of crime and crime trends in the neighborhood or area
  - (b) Researching the history of violent and property crime in the immediate neighborhood and on the premises during the past 3 years
  - (c) Developing a relationship with local law enforcement agencies to familiarize them with the property
  - (d) Requesting local police to include the property in their patrol routes
  - (e) Participating in local security associations or industry trade groups as a means of sharing common security concerns and solutions
  - (f) Checking the exterior of the facility regularly for the following:
    - i. Signs of criminal acts, vandalism, and arson
    - ii. Transients or vagrants living on or around the property
  - (g) Provisions for dealing with the public and the media. With the recent and continuously evolving social media tools has come the need to develop dynamic media plans to provide instantaneous information as events evolve. Past practices of assembling designated individuals and comprehensive gathering of information are becoming obsolete in a world of instantaneous written and video

social media. It is especially important for the governing bodies of historic properties, especially those that rely upon gate receipts to sustain themselves, to get information out to the public quickly and continuously. Slow response can result in the public's misunderstanding as to the impact of an event. The perception of an event can be as serious as the event itself.

The historic property assessment matrix in Table A.9.11.1 provides general guidance for selecting levels of protection that are appropriate for the significance and integrity of a historic structure. This matrix is only a guide; determining the proper protection for each specific application calls for collaboration among the owner, other stakeholders, and the AHJ (collectively, the project team). Depending on conditions, the project team might need the services of a security consultant. The selected protection measures should be reviewed by the project team and approved by the AHJ.

To use Table A.9.11.1, the historic structure should be rated on the seven elements in Part A on a scale of 1 to 5 and the scores totaled. The user should then refer to Part B for recommendations.

**A.9.11.2** Bars or gates on historic windows or historic doors should be designed to allow for emergency egress in case of fire, and portal control systems should be designed to meet life safety and fire code regulations, as well as legal requirements for accessibility by persons with disabilities.

**A.9.11.3** Improvements to protect a historic structure or site from a security threat can introduce new, incompatible changes or elements into the historic landscape. Inadequate planning and an emergency response after a security event has occurred can destroy the very values for which the historic property was commemorated. *The Secretary of the Interior's Standards for the Treatment of Historic Properties with Guidelines for the Treatment of Cultural Landscapes* provides guidance relative to the issue of alterations or additions to historic landscapes to accommodate new uses and defines four levels of treatment: preservation, rehabilitation, restoration, and reconstruction. Relative to landscape changes or the introduction of new elements, rehabilitation is perhaps the most used treatment. According to *The Secretary of the Interior's Standards*, "Rehabilitation is defined as the act or process of making possible a compatible use for a property through repair, alterations and additions while preserving those portions or features which convey its historical, cultural, or architectural values."

The rehabilitation treatment as defined by *The Secretary of the Interior's Standards* includes 10 criteria for consideration when rehabilitating historic structures or landscapes as follows:

- (1) A property will be used as it was historically or be given a new use that requires minimal change to its distinctive materials, features, spaces, and spatial relationships.
- (2) The historic character of a property will be retained and preserved. The removal of distinctive materials or alterations of features, spaces, and spatial relationships that characterize a property will be avoided.
- (3) Each property will be recognized as a physical record of its time, place, and use. Changes that create a false sense of historical development, such as adding conjectural features or elements from other historic properties, will not be undertaken.
- (4) Changes to property that have acquired historic significance in their own right shall be retained and preserved.
- (5) Distinctive materials, features, finishes, and construction techniques or examples of craftsmanship that characterize a property will be preserved.
- (6) Deteriorated historic features will be repaired rather than replaced. Where the severity of deterioration requires replacement of a distinctive feature, the new feature will match the old in design, color, texture, and where possible, materials. Replacement of missing features will be substantiated by documentary and physical evidence.
- (7) Chemical or physical treatments, if appropriate, will be undertaken using the gentlest means possible. Treatments that cause damage to historic materials will not be used.
- (8) Archeological resources will be protected and preserved in place. If such resources must be disturbed, mitigation measures will be undertaken.
- (9) New additions, exterior alterations, or related new construction will not destroy historic materials, features, and spatial relationships that characterize the property. The new work will be differentiated from the old and will be compatible with the historic materials, features, size, scale and proportion, and massing to protect the integrity of the property and its environment.
- (10) New additions and adjacent or related new construction will be undertaken in such a manner that, if removed in the future, the essential form and integrity of the historic property and its environment would be unimpaired.

*The Secretary of the Interior's Standards* goes on to state, relative to "Alterations/Additions to a Landscape" for a new use: "When alterations to a historic landscape are needed to assure its continued use, it is most important that such alterations do not radically change, obscure, or destroy character-defining spatial organization and land patterns or features and materials. Alterations may include enclosing a septic system, increasing lighting foot-candles, extending accelerations or deceleration lanes on parkways, or, additional new planting to screen a contemporary use or facility. Such work may also include the selective removal of features that detract from the overall historic character.

"The installation of additions to a historic landscape may seem to be essential for the new use, but it is emphasized in the Rehabilitation guidelines that such new additions should be avoided, if possible, and considered only after it is determined that those needs cannot be met by altering secondary, i.e., non-characterizing spatial organization and land patterns or features. If after a thorough evaluation of alternative solutions, a new addition is still judged to be the only viable alternative, it should be planned, designed, and installed to be clearly differentiated from the character-defining features, so that these features are not radically changed, obscured, damaged, or destroyed. For example, construction of a parking lot in a secondary meadow that is enclosed by existing vegetation or installing contemporary trail signage that is compatible with the historic character of a landscape.

**Table A.9.11.1 Historic Property Assessment Matrix**

<b>Part A: Assessment</b>					
	<b>Level 5 (5 Points)</b>	<b>Level 4 (4 Points)</b>	<b>Level 3 (3 Points)</b>	<b>Level 2 (2 Points)</b>	<b>Level 1 (1 Point)</b>
Significance	World Heritage Site, National Historic Landmark	Nationally significant	Regionally significant	Locally significant	Common; little or no local significance, associative, design, construction, or information value
Integrity of historic fabric	90% or more historic fabric	75% or more historic fabric	50% or more historic fabric	More than 50% reconstruction	Little remaining historic fabric
Use	Open to the public; uncontrolled access	Mixed use; public access and offices, retail, and/or storage	Open to the public; monitored access	Open to the public; monitored and controlled access	Storage only; no public access
Response	No fire department or police response available; no road access	Fire department or police response greater than 30 minutes; rural road access without developed utility services; seasonal road access difficulties	Rural road access with developed utility services less than 30 minutes.	Fire department or police response less than 20 minutes; urban access with minor vegetative or physical constraints	Fire department or police response less than 10 minutes; urban access, no vegetative or physical constraints
Location	High crime area; perimeter easily accessible after hours	High crime area; perimeter not easily accessible after hours	Low crime area; perimeter easily accessible	Low crime area; perimeter not easily accessible	Low crime area; secured perimeter 24/7 or perimeter difficult to access
Construction Type (See NFPA 220 for additional information)	Type V: Wood frame (light combustible construction)	Type IV: Heavy Timber (heavy combustible construction)	Type III: Masonry walls, wood floors (partial combustible construction)	Type II: Noncombustible (noncombustible construction)	Type I: Fire resistive (non-combustible construction).
Adjacent buildings	Severe: Adjacent attached buildings highly attractive targets for arson, vandalism, or acts of terrorism	High: Adjacent, buildings with high potential as targets for arson, vandalism, or acts of terrorism	Moderate: Adjacent buildings at moderate risk of arson, vandalism, or acts of terrorism	Low: Adjacent buildings at low risk of arson, vandalism, or acts of terrorism	Very Low: No adjacent buildings or adjacent buildings highly unlikely targets for arson, vandalism, or acts of terrorism
Scores					
<b>Total Score</b>	<b>Part B: Recommendations</b>				
7–10	Basic physical security measures to limit access to the building or site such as door and window locks				
10–15	Additional physical security measures to deter unwanted activities, such as site lighting, site fencing, or landscape features that limit or deter access				
15–20	Additional physical security measures to deter and delay unwanted access to the property, such as high security locks, reinforced doors and windows, security fencing, and landscape plantings that limit access to the site				
20–25	Physical security features listed above; access control systems, such as card-reader-controlled gate and door locks; electronic premises security systems that detect unauthorized access and sound a local alarm; periodic patrols by security personnel or police				
25–30	Physical security and access control features listed above; electronic premises security systems that detect and report unauthorized access to the police or a UL-listed central station; closed circuit television system with on-site monitoring and recording capabilities; security personnel on site when the property is open to the public; frequent patrols by security or police personnel after the property closes to the public				
30–35	Physical security features, access control systems and electronic premises security systems listed above; physical barriers or landscape features to prevent unauthorized vehicle access to the property; closed circuit television system with on-site monitoring and recording capabilities; security personnel on site 24/7				



“It is important to remember, however, that the existing landscape may not be reflective of the true historic landscape because landscapes change over time, so when evaluating proposed physical changes to a landscape the opportunity may exist to implement those improvements, while restoring the original historic landscape. In addition, preservation of historic landscapes can also create security problems. For example, overgrown shrubbery can provide concealment, and trees planted too close to a fence line can serve as a means for scaling fences. The owner should consider methods to provide clear zones between the tops of shrubbery and the bottom branches of the trees, to accommodate surveillance purposes.”

**A.9.11.4** Examples of changes include outside changes to landscape or removal of fences and allowing public access to previously inaccessible areas.

**A.10.1** A management operational system is a tool whereby those responsible for the fire protection plan can consider trained staff as part of the overall fire protection strategy for the building. A management operational system can be considered in those instances where the installation of systems or the construction of fire safety features would cause unacceptable damage to the historic fabric.

Paragraphs 8.1.3.1 and 9.4.5.5 permit management operational systems controls to compensate for prescriptive solutions as equivalent alternatives or modifications and to be used as part of a performance-based approach to code compliance, respectively. This chapter sets the criteria that needs to be used to design, evaluate, and verify such systems.

This chapter is applicable to historic buildings where the project team determines that conformance with at least one of the following prescriptive provisions to which the historic building is subject would result in the following:

- (1) Cause unacceptable damage to historic fabric of the building
- (2) Create an excessive and unreasonable economic burden
- (3) Would not achieve the intended objective of the code
- (4) Be physically or legally impracticable
- (5) Entail a change so slight as to produce a negligible additional benefit consistent with the purposes of the code

This chapter is applicable to historic buildings when the project team and the design professional responsible for a performance-based design determine that elements described in this chapter are sufficiently reliable to permit their use in the model(s) used.

Management operational systems can include, but are not limited to, the following:

- (1) Policies
- (2) Procedures
- (3) Trained staff
- (4) Management oversight
- (5) Access control
- (6) Other management practices and procedures acceptable to the authority having jurisdiction

**A.10.2** NFPA 909 is intended to apply to culturally significant structures and their contents. As such, it also applies to staffed buildings that have substantial public visitation. Its requirements thus might exceed what would be appropriate for historic buildings that do not have significant contents and little public presence. It should be kept in mind that historic buildings have a broad range in size and occupancy — from

private residences to large public assembly uses — with a related range of fire safety issues.

New additions to historic buildings are normally required to be designed in conformance with new construction code requirements. There is no basis for exempting additions based on their historic character, damage to historic fabric, or other factors that may apply to historic buildings.

**A.10.2.1** Owners, governing boards, and staffs of historic structures have a significant responsibility for the preservation and protection of property entrusted to their care. Such stewardship might rest with managers, curators, or administrators who are qualified in conservation but have little knowledge or experience in fire safety. Nevertheless, it is the duty of persons responsible for historic structures to manage and operate their buildings to prevent fires, reduce losses, and respond appropriately to emergencies. There is an obligation to ensure that fire hazards are identified and analyzed by qualified staff or consultants and that corrective measures are taken without negative impact on structural integrity. Those in charge need to recognize that there are fire problems inherent in operating a historic structure and that appropriate policies and procedures need to be developed and implemented.

Fire emergency planning responsibilities should include the following:

- (1) The facility’s governing body or those responsible for the institution should establish and maintain plans and programs to protect against the disastrous effects of fire.
- (2) In carrying out this responsibility, a fire risk assessment should be conducted. (*See 5.1.1.1.2 of NFPA 909 for guidance in conducting this assessment.*)

The facility’s governing body should appoint a fire safety manager who is responsible for the protection of the site from fire. The fire safety manager’s duties include responsibility for the following:

- (1) Life safety systems
- (2) Fire prevention
- (3) Fire inspections
- (4) Periodic property surveys
- (5) Proper operation of fire protection equipment such as fire detection and fire suppression equipment
- (6) Portable fire extinguishers

Other duties should include plans for fire safety of new construction, renovations, or installation of displays or exhibits.

**A.10.3** A fire emergency response plan might be included as part of a broader, more comprehensive disaster management program such as that addressed by *NFPA 1600*.

**A.10.4.1** Operational controls should be clearly defined and documented and the responsibility for accomplishing them should be assigned to specific individuals who are accountable for maintaining and enforcing them. These responsibilities should be formally assigned in writing so that there is no doubt as to responsibilities, reporting lines, and the allocation of resources.

**A.10.4.2** Operational controls are likely to include a combination of prescriptive and performance-based compliance elements and may use trained staff, written policies and procedures, or other management tools to offset prescriptive code requirements. For example, in a special exhibit that introduces an open flame device the increased risk may be offset by post-

ing a fire watch. Similarly, security requirements for a high-value exhibit in a historic building might be offset by posting additional security staff near the exhibit or limiting access to the exhibit with temporary barriers, or other similar management actions.

**A.10.4.3** Operational controls should consider all elements of the historic property's operation, management, and mission. For example, an access control policy that prevents legitimate public access to view a portion of a historic building is not appropriate for the institution's educational mission. Operational controls should strike a balance between the cultural resource properties various, sometimes conflicting, objectives.

**N A.10.7.3(2)** Staff participation in drills is an important part of a successful outcome following an emergency. As staff changes or conditions in the building change, further drills will be necessary to ensure that the response during an emergency follows the fire safety management plan. If new systems are installed or modifications to a fire protection or life safety system occur, conducting a drill might be necessary.

**N A.10.7.3(5)** The intent of the changes identified in 10.7.3(5) are those that occur to components attached to or integrated with the building or structure. Examples of changes addressed by 10.7.3(5) might include a change to the type of hydraulic fluid used in the elevator and modifications to interior finishes.

**A.10.10** When a noncompliance item is revealed, actions that the AHJ can take include revoking approval of the management plan and requiring conformance with the prescriptive provisions of the code to which the building is subject.

Where a compliance audit reveals noncompliance with the approved management plan or changes in the use or arrangement of the building, the AHJ has the authority to set deadlines for compliance and to prohibit occupancy of the building by the public, the staff, and volunteers.

**A.10.12** Prior to the opening of the building, the fire safety manager should ensure that all necessary preparatory measures are taken. Items to consider include the following:

- (1) Removing all secondary security measures such as chins, bolts, and locking bars from fire exit doors.
- (2) Ensuring that there are no faults in the fire protection systems.
- (3) All egress routes are free and unobstructed.
- (4) All illuminated exit signs are lit.
- (5) Portable fire extinguishers that could have been moved are replaced in the correct location.
- (6) Security personnel are briefed on any special activities scheduled to take place, such as contractor operations.

Similarly, prior to the closing of the building, the fire safety manager should ensure that all necessary preparatory measures are taken. Items to consider include the following:

- (1) Assuring that all interior doors are closed
- (2) Checking portable appliances and equipment to ensure that they are turned off
- (3) Checking that windows and doors are locked against entry
- (4) Ensuring that trash containers are emptied and trash removed from the building
- (5) Ensuring that smoking materials are extinguished and removed from the building

**N A.11.2.1** Decorative materials are often used for special events, occasions, and holidays.

**N A.11.2.2** Ignition sources can include, but are not limited to, light fixtures, radiators, electric heaters, and other heat-generating devices.

**Δ A.11.2.4** Where historically significant artifacts such as painted stage drops, tapestries, and antique flags are displayed in public gathering places there is a need to balance fire and life safety requirements with the preservation needs of the artifacts. Life safety standards, including NFPA 101, mandate fire-retardant treatments for fabrics that are used in gathering places, with NFPA 701 referenced as a test protocol. NFPA 701 requires a destructive burn test of a fabric sample to verify compliance with the standard; however, this action will cause permanent damage to the material and is not recommended by accepted preservation practice. Additionally, specific chemical treatments that **can** be applied to reduce combustibility **could** also result in irreversible harm to fabrics. Nonetheless, there is a need to protect artifacts and the locations in which they are housed from fire, and safeguards must be implemented for situations where artifacts are displayed in assembly spaces. These should include, but not be limited to, prohibiting open flames (e.g., candles, lamps, and smoking), avoiding the use of heat-producing appliances such as food and beverage preparation equipment within the room, or adding a fire watch where the artifact is located. The use of cool burning lamps such as a fluorescent or LED within the space is recommended, and no lights, electrical devices, or cables should be located within 1 m (36 in.) of the artifact.

**N A.11.2.4.1** The placement of a combustible artifact within an assembly space should be approved by the authority having jurisdiction; however, the authority having jurisdiction should consult with disciplines that have expertise in preservation and protection of artifacts before making a decision.

**A.11.4** A high standard of housekeeping is the most important factor in the prevention of fire. Maintaining this high standard of housekeeping is every employee's responsibility; however, it is the facility director who assumes the final responsibility for this important activity.

**N A.11.4.4** Air handling equipment includes stacks, exhaust ducts, and filters.

**A.11.4.8.1** Combustible packing materials include materials such as shredded paper, Styrofoam packing material (peanuts), plastic, and excelsior.

**A.11.7.2** Arc-fault circuit-interrupter (AFCI) devices should be installed on all existing branch circuits rated at 15 and 20 amps. NFPA 70B includes good practice and recommendations that can be applied to routine maintenance of most types of electrical equipment and devices.

**A.11.7.5** NFPA 70 requires that all 120-volt, single phase, 15- and 20-ampere branch circuits supplying outlets in dwelling unit bedrooms shall be protected by a listed AFCI, combination type installed to provide protection of the branch circuit. Although many historic structures do not include dwelling units, the branch circuits may utilize older wiring methods and materials that, due to age-related deterioration, are more subject to arcing faults than those found in new installations.

**A.12.1.1** Physical security devices can include, but are not limited to, locks, doors, windows, safes, vaults, and strong rooms.

All exterior openings that are accessible to intruders, including main and side doors, delivery entrances, windows, skylights, roof hatches, and openings for ventilation, should be evaluated with respect to their resistance to forced entry and should be adequately secured. Doors should be of solid construction and provided with high-security locking hardware. Glass panels and sidelights in exterior doors should be protected with wire mesh screens. If not in conflict with life safety requirements, ground floor windows should be protected with wire mesh screening or the glazing replaced with burglary-resistant glazing materials.

Security personnel and trained staff can be an effective and useful component of a facility's physical security program. Security services should be considered under any of the following conditions:

- (1) When the mission or significance of the facility is particularly important
- (2) When an in-house response capability is needed (e.g., the facility contains alarmed vaults or other sensitive operations, and off-site security personnel or police are not close enough for quick response)
- (3) The facility is vulnerable to theft or damage (e.g., a historic structure's location in a high-crime area)
- (4) Pedestrian or automobile traffic is heavy or congested and requires special controls
- (5) Valuable artifacts are stored or used in the facility

Management should consider having some of their security personnel visible to deter criminal activity. To be most effective, security personnel should patrol the premises on a regular schedule but not in a predetermined pattern. Patrol rounds should include exterior grounds, the building perimeter, parking areas, stairwells, exit and delivery corridors, and storage, receiving, and trash disposal areas. The number of security personnel on patrol can vary by time of day, day of the week, and the season of the year, depending on local security problems, peak traffic periods, and special events.

**A.12.1.2** Integration of security equipment with fire alarm and building management equipment provides for centralized control of these functions and savings in personnel and equipment costs.

**A.12.2** The preferred method of controlling access to a facility is to have one means of entry and exit for vehicles. The volume of traffic at the facility, however, can require more than one entry and exit. For public facilities, entering and exiting vehicles and pedestrians should be required to pass by constantly attended cashiers' plazas. Cashiers' enclosures should be designed to allow 360-degree visibility. Hydraulic or motorized drop-arm gates can be used to control entry and exit of vehicles.

Different historic settings or structures, such as single, stand-alone buildings, or campus-style settings with multiple buildings, require different access control approaches. The needed level of security will depend on the degree of risk involved. Historic structures with valuable resources, products, expensive equipment and furnishings, or valuable art collections are at greater risk to unauthorized intruders and, therefore, require a higher level of access control. The United States national monuments lend themselves as the most vulnerable and desirable terrorist targets when compared to regional or locally significant historic structures, which have little vulnerability to terrorism and are more vulnerable to vandalism or arson.

The types of uses or activities also affect the level of needed security. For example, a historic building with a restaurant or theater tenant would be more vulnerable than a public building with very controlled hours of operations. The restaurant or theater tenant is usually open after normal business hours and on weekends, requiring additional security during these periods. A historic office building with residential tenants who require 24-hour access is another scenario having unique security needs.

*The Secretary of the Interior's Standards* provides additional guidance in the section titled *Accessibility Considerations/Health and Safety Considerations/Environmental Considerations and Energy Efficiency*, as follows: "These sections of the Rehabilitation guidance address work done to meet accessibility requirements; health and safety code; environmental requirements; or limited retrofitting measures to improve energy efficiency. Although this work is often an important aspect of preservation projects, it is usually not part of the overall process of protecting, stabilizing, conserving, or repairing character-defining features; rather, such work is assessed for its potential negative impact on the landscape's character." For that reason, particular care must be taken not to obscure, damage, or destroy character-defining materials or features in the process of undertaking work to meet code and energy requirements.

While many historic structures and sites can be viewed as open environments where visitors and staff can roam freely, a portal control program should be implemented to permit authorized individuals to come and go with ease, while restricting access to unauthorized persons. Exterior entrances, other than the main lobby common area entrance(s), should have automatic door closers and locks, and a program should be in place to ensure that all remote or unattended entrances are locked after hours. Video surveillance can be used to monitor these entrances.

**A.12.2.1** One major advantage of electronic access control systems is the ease with which codes can be changed to delete lost or stolen machine-readable credentials from the system. Access control systems can range from basic systems that operate a single lock on a door to computer-operated systems that electronically tie together hundreds or thousands of locks. In these systems, a machine-readable credential serves as a key to operate the lock on a door. The same principles of key control apply to the issuance of machine-readable credentials. Newer technologies are available with cards that can perform a variety of functions. In addition to functioning as a photo ID and an access card, the card can function as a library card, debit card, and meal-plan card.

**A.12.2.2** Strict control of keys and proper maintenance of locks are essential to good security. At the end of each day, the building should be checked to ensure that nobody has stayed behind and that all doors and windows are securely locked.

**A.12.3** Video surveillance systems and video motion detectors are widely used as a means of providing security for structures and sites. It is important to remember that lighting levels might be required to be increased for proper operation of the video surveillance system. In addition, imitation cameras should never be used as they can give a false sense of security, and they are relatively easy to recognize. Video surveillance without staff to monitor it is a tool for recording historical data that can be used to evaluate access control and traffic patterns and reviewed after-the-fact for evidence of criminal activity. Video surveillance systems monitored by staff at a reception desk or at

a separate security console can provide real-time information to increase security staff effectiveness.

Intrusion detection systems should be used in areas where access is not permitted at certain times and where a quick response to an intrusion is desired. Such systems can be tied into a video surveillance system so that on activation of an alarm, a recording is made of the scene. An alarm system that sends a signal to a monitoring station, which then dispatches designated personnel, is preferred. An alarm system that sounds a local bell is better than no alarm at all; at the very least, it might scare off an intruder. The effectiveness of alarm devices, physical barriers, and intrusion detectors depends on a response by staff, police, or security personnel.

**A.12.4** The interior and the front and rear entrances of the premises should be well lit. Adequate outside lighting of the parking area and approaches during nighttime hours of operation enhance employee and customer protection. Because of the significant risks they pose, parking facilities are to be afforded special consideration. Local ordinances and building codes, or **IES RP-20-14**, *Lighting for Parking Facilities*, can mandate lighting requirements.

**A.12.5.2** A qualified person should be assigned overall responsibility for site security during the project. Where security officers are assigned to the work site, officers on duty should be informed of all locations where work is performed. They should be instructed to thoroughly and carefully check each of those locations during their regular patrols of the work site and to look for evidence of smoldering.

A major function of the security force is patrolling the property. Security patrols should focus on the prevention of crimes and the elimination or reduction of criminal opportunities, rather than the traditional police model of reacting to crime. To that end, security officers should be schooled in the principles of crime prevention and trained in the techniques of preventive patrols. Additionally, the security patrol should be aware of any fire protection equipment impairments that could affect the security of the building. For example, a sprinkler system valve that is closed could allow an arson fire to spread uncontrolled, or a construction hazard, such as welding, could allow a fire to establish itself and threaten the facility. A fire could also be used to distract security while a theft is in progress.

If contract security is used, the security contractor is responsible for the selection, training, and supervision of personnel and for complying with state and local laws, rules, and regulations.

**N A.13.3** It is recognized that fire protection and life safety systems for historic structures involve a wide range of sophistication, from simple to highly complex. The owner or owner's representative should meet with the AHJ to determine the needed scope of system commissioning and to decide what systems are subject to commissioning. The intent of this code is that the protocol for commissioning be appropriate to the risk while being sensitive to the unique attributes and challenges faced by those responsible for historic structures.

When determining the level of risk and the systems to be commissioned, it is important to recognize that system commissioning is a critical part of the process to ensure that fire protection and life safety systems work as intended. Where it is

practical, all fire protection and life safety systems should be commissioned in accordance with NFPA 3.

**N A.13.12** Additions, alterations, and rehabilitation can affect fire protection and life safety systems. It is important to verify that all integrated systems function as intended.

It is recognized that the level of system integration ranges from simple to complex. For example, NFPA 4 points out that many buildings have limited integrated systems and states that a test plan is not required for these buildings; however, integrated testing of these systems should still be conducted. For these buildings with limited integrated systems, initial testing can be performed in conjunction with acceptance testing of the individual systems to simplify the process.

The determination of whether integrated testing is necessary for a particular building should be made on a case-by-case basis and the AHJ should be consulted. Examples that could assist in determining whether a building has limited integrated systems are provided in A.4.5.3 of NFPA 4. NFPA 914 recognizes the importance of integrated systems and intends that this testing be appropriate for the risk.

**A.14.1.1** Demonstrated knowledge might be evidenced by experience with similar properties or submission of designs and solutions that exhibit an understanding and sensitivity to the impact of their systems on historic structures. Interviews, pre-design conferences, and verified referrals or recommendations from other historic structures are useful methods for identifying contractors and personnel with a true understanding of the special needs and concerns of historic structures.

**A.14.1.2** Prequalification of contractors and referrals can be used to find contractors experienced in dealing with historic structures. Project specifications should spell out the special precautions needed for the construction activity. Job site meetings should be used to familiarize laborers as well as craftsmen with these special concerns. Curators and key staff members should take part in these meetings.

**A.14.1.3** Knowledge and experience in working with historic structures are critical to ensure that the contractors are sensitive to the value and damageability of the building. Criteria that can be used in determining whether a contractor is qualified to work on this type of project include the following:

- (1) Education and training in the historic structure field
- (2) Experience with similar types of projects of similar size and complexity
- (3) Satisfaction of management at other historic structures with the contractor's sensitivity and suitability of results
- (4) Demonstrated success in meeting time, quality, cost, and protection requirements
- (5) References from similar historic structures
- (6) Proposals that demonstrate sensitivity to the special needs of the historic structure

**A.14.1.4** See NFPA 241.

**A.14.1.5** It is important to spend time at the beginning of the project to make sure that all contractors and subcontractors understand the nature of the project and special building features that require protection during construction, and other curatorial concerns. A meeting also provides an opportunity for contractors and other workers to ask questions or review alternative approaches that might have an impact on other contractors or better address curatorial concerns. Participants

should include all contractors, subcontractors, workers, security staff, and curatorial staff, depending on the size of the historic structure and the project. Based on items discussed in this meeting, a contract can be drawn up detailing security and protection requirements for the project; as an added measure each contractor or worker on the project might be asked to sign the contract.

**A.14.4.2.2.1** Excess quantities of flammable and combustible liquids should be stored downgrade from the project when possible. The storage site should also be a sufficient distance away from heavy traffic areas to minimize the exposure to personnel and others.

**A.14.5.7.3** Use of fluorescent lighting should be encouraged to avoid fire hazards associated with hot lamps coming in contact with combustible materials and being improperly stored after use.

**A.14.7.1.1** Where security is of concern, a lockbox should be provided for this information.

**A.15.1** Applicable NFPA standards establish minimum inspection and testing frequencies, responsibilities, test routines, and reporting procedures for each type of system.

**N A.15.3.3.4** Many structures have integrated systems, including automatic sprinkler and other water-based systems, fire alarms, smoke management, and so forth. These systems are often interconnected. Testing to ensure that the integrated systems function as intended is critical for reliable fire and life safety protection.

**A.16.1** Each special event requires the evaluation of a number of considerations to insure the protection of the historic property. Some of those considerations include:

- (1) **Planning for Special Events:** Historic structures generally will have a security program to deal with normal, daily activities. There are occasions, however, when these properties will be the scene of a special event, such as a musical concert, dramatic production, blockbuster exhibition, or a visit by a VIP, at which large crowds are expected. For such events, a security program should be implemented to control the crowds, maintain proper means of egress, and avoid panic in the event of an emergency. When the event takes place on public property, security is generally the responsibility of law enforcement. On private property, the governing body or those responsible for the historic structure are responsible for security, although the participation and cooperation of public law enforcement can be required. In addition, although a large event takes place on public property, there can be a spillover onto surrounding private property, creating unplanned for security exposures.
- (2) **Security Vulnerability Assessment:** The governing body should conduct a vulnerability assessment before the event and from that assessment develop and implement appropriate security procedures.
- (3) **Security Program:** Behind every successful event is a security and crowd control program. The key to making the program successful is planning and preparation. While a facility can have a general security and crowd control program in place, the program should be tailored to meet the needs of each specific event. In performing a security vulnerability assessment for a

special event, the following sections should be reviewed for applicability and consideration.

- (4) **Security Committee:**
  - (a) If the magnitude of the special event warrants, a security committee should be established and should consist of representatives from facility management, risk management, safety, support personnel (ushers, ticket sales personnel, etc.), event promoters, and security. A security coordinator should be appointed, and all matters dealing with security at the event should be communicated through this individual.
  - (b) Meetings of the committee should be held on a regular basis to review event planning, discuss problems and report progress. Following the full committee meeting, individual departments should meet to review their needs and requirements.
  - (c) The security committee should review experiences with prior events to determine what worked and what didn't, and what problems were experienced and how these could impact the present event.
- (5) **Statement of Purpose:** The committee should develop a statement of purpose to provide focus for the security program. An example of a statement of purpose is: "The goal of security for this event is to provide spectators or visitors, participants, and support personnel with a safe and secure environment in which to enjoy the activity, with contingencies in place to address any concerns that can arise before, during or after the event."
- (6) **Event Planning Measures:**
  - (a) **Personnel**
    - i. Police officers can be employed to meet security personnel needs; however, police officers can be called away, even during the event, to handle an emergency.
    - ii. Special events can also require the hiring of temporary workers to assist in handling concessions, custodial services, and other non-security tasks. Because of the short-term need for these workers, they are generally hired without undergoing any background or reference checking. One solution to this problem can be to hire temporary workers only from agencies that perform background checks.
    - iii. The type of event (rock concert, blockbuster exhibit, VIP visit, etc.) and the estimated crowd size will determine the number of crowd control personnel (security personnel, law enforcement personnel, as well as ushers and ticket takers). The event planners and/or sales personnel should keep the security committee informed on a regular basis on the latest projected attendance figures, and staffing needs should be adjusted accordingly. While there are no rules to determine the number of crowd control personnel required at an event, a review of past events can provide a benchmark for making a determination.

- iv. The telephone number for contacting emergency medical services (EMS) personnel should be readily available for all events. At large events (crowds larger than 10,000 people), EMS personnel should be on-site. Crowd control and security personnel should be instructed on how to initiate a medical response.
  - (b) Identification Badges: Event staff should be provided with picture identification cards that are worn visibly at all times. These cards can also function as access control cards. Temporary staff should be provided with temporary identification cards. These cards should be of a distinct and easily noticed color and should be worn at all times.
  - (c) Access Control: Access control at exterior entrances and loading docks is an important consideration before and during an event. All exterior doors, except those used for visitor entrance, should be kept locked on the outside at all times. Employees should be required to enter the facility through a controlled employee entrance. Admittance can be automated through the use of an access control system.
  - (d) Control Center: Consideration should be given to establishing a control center to serve as a central communication point for coordination of all activities related to the event. Representatives from security, law enforcement, EMS, and facility management should be assigned to the center, which should be centrally located within the facility. Communication for security personnel can be by portable radio or other means.
  - (e) Parking and Traffic Control:
    - i. Parking and traffic control play integral roles in the success of an event, since delays caused by either can result in delays in crowd ingress, which could delay the start of the event. Traffic control can also greatly affect crowd egress. For events at which a large volume of cars are expected, law enforcement should be requested to provide traffic control on local roads.
    - ii. Based on the projected attendance, a determination can be made if there will be sufficient parking on the property. If on-site parking is insufficient, it might be necessary to provide satellite parking. Transportation to and from the satellite parking, and safety, security, and traffic control at the satellite parking should also be addressed.
    - iii. Close proximity parking problems can also affect emergency medical assistance procedures. Parking areas must be monitored to ensure that emergency vehicles have access to and from the facility. Also, a few vehicles parked in the wrong areas can create chaos both when guests are arriving and when they are leaving.
- (7) Ingress and Egress:
- (a) General:
    - i. Since most patrons (visitors) arrive within twenty minutes before the start of an event, staffing needs for ticket personnel and/or gate personnel are greatest during this period. Once the event starts and the ingress traffic slows, staffing levels can be reduced and personnel reassigned to patrols or elsewhere.
    - ii. In the event of an emergency, procedures must be in place to facilitate the orderly exiting of the crowd from the facility; gate personnel should be readily contacted so they can assist in the effort. Means must be provided for guests or patrons to exit the facility throughout the event. Emergency exits should allow for the free flow of the crowd from the facility.
    - iii. If turnstiles or gates are used during crowd ingress and these same portals are used for egress, at the end of the event the turnstiles and gates should be opened to facilitate the exiting crowds. While most of the crowd will exit at the end of an event, it is common for a large portion of the crowd to begin leaving before the event ends.
  - (8) Entry Screening: Entry screening can range from visual inspection and bag searches of suspicious people to searches by metal detectors and hand-held wands of all people. The goal of the screening is to remove items that can turn into dangerous missiles or weapons. The history of past events (VIP visit as compared to a special exhibit) can help to determine the level of screening used. Patrons who refuse the search should be denied entry.
  - (9) Patrols: Security personnel should be assigned to patrol the crowd during the event. Patrols serve as the eyes and ears for the staff in the control center. Patrols should check in on a regular basis to the communication center.
  - (10) Other Considerations:
    - (a) Bomb threats are often used by disgruntled employees and others to disrupt an event. They have also become the weapon of choice for terrorists. A plan should be in place for handling bomb threats as well as procedures for evacuating a facility and conducting bomb searches.
    - (b) Special events also present an opportune time for groups to express their views through a public demonstration. These demonstrations can occur without any forewarning and, at times, escalate to violence. Local law enforcement should be contacted immediately at the first sign of a demonstration.
    - (c) Handling Disturbances, Ejections, and Arrests: Event planners should develop policies and procedures as a means of providing staff with guidelines on how to handle disturbances. Staff should also be trained regarding actions that can be taken within the limits of the law in dealing with disturbances and, in particular, in ejecting and/or arresting spectators. Event planners should request assistance from the local police in training staff on the proper procedures to follow in ejecting a spectator or making an arrest. The following are some suggested guidelines for staff to follow:

- i. An incident report should be filed on actions taken by staff immediately after an incident has occurred.
- ii. Staff should stay calm and speak clearly when dealing with those involved in the disturbance. They should also avoid being patronizing or aggressive, since these attitudes can lead to an escalation in the situation. Staff must keep a level head about what is taking place.
- iii. If alcohol will be served at the event, policies should be developed and staff trained in serving alcohol and in handling intoxicated patrons.
- iv. If it appears that a fight or altercation can take place between patrons, staff should immediately call for help. Depending on the circumstance, it is generally preferred that staff waits until help arrives before attempting to quell the disturbance. If possible, staff should remain in contact with the control center throughout the disturbance.
- v. An action staff can take in handling any disturbance is to ask the individual(s) involved to comply with policies.
- vi. Patrons who are uncontrolled, who exhibit rowdy behavior or endanger the safety of others, or who fail to cooperate with the repeated requests of staff should be ejected from the event.
- vii. A plan should be developed to respond to physical disturbances.
- viii. Law enforcement should handle all ejections and arrests, since they are usually more experienced in the proper procedures to follow.

**A.16.8.3** In those jurisdictions where formalized programs are in place, licensed or registered electricians should be utilized to complete the work. Using contractors with experience and knowledge of *NFPA 70* can help to greatly reduce the chance of fire ignition from electrical wiring and components.

## Annex B Planning and Design Appraisal

*This annex is not a part of the requirements of this NFPA document but is included for informational purposes only.*

**B.1 Objectives in Rehabilitation Planning.** The primary fire protection objective in rehabilitation planning is to achieve the best protection program for the historic building while maintaining its historic integrity and character. Because of the unique character of each historic structure, achieving this objective necessitates an understanding of historic preservation and fire protection concepts.

**B.1.1 Historic Preservation.** Historic buildings should be treated with the sensitivity prescribed by conventional historic preservation criteria and standards.

**B.1.2 Secretary of the Interior's Standards.** See Annex N for the U.S. Secretary of the Interior's guidelines for rehabilitation and operation of historic sites.

### B.2 Administrative and Review Requirements.

**B.2.1 Historic Preservation.** Depending on funding sources and federal, state, or local legislation, review by state or federal

preservation offices of local historic review commissions might be required to ensure that the historic building is treated with sensitivity. Projects should be discussed with the appropriate preservation authorities as early as possible in the planning stages.

**B.2.2 Code Enforcement.** Proposed rehabilitation projects should be discussed with the appropriate building and fire code officials as early as possible in the planning stages to determine if code or safety conflicts exist. Many codes have special provisions for historic buildings and for the consideration of alternative methods or systems that will provide levels of safety equivalent to those required for new construction (*see NFPA 101*). In some cases, special appeal or variance boards exist and should be requested to address those situations where fire safety and protection concerns and historic preservation goals cannot be resolved acceptably by the standard review process. Most building code officials are willing to work with owners, architects, and engineers and to consider alternative construction methods, provided a reasonable or equivalent level of life and property protection is proposed.

### B.3 Concepts of Fire Safety Planning.

**B.3.1 Management Responsibility.** The key to any successful fire protection program lies in the effort extended by the management. Without the active participation and direction of high-level management, the effectiveness of the fire protection will be seriously hindered. This is true in an operational facility as well as in a facility undergoing rehabilitation.

Fire safety is an essential and permanent part of historic structure operations and should be a key consideration when that structure is scheduled for rehabilitation. Owners and others entrusted with the management or operation of buildings having historic significance have prime responsibility for ensuring that the historic structure is protected against the disastrous effects of fire.

Using advice from qualified fire safety professionals (*see Annex E, Resources for Protection of Cultural Resource Property Projects*), the management team should develop fire safety objectives and a fire safety plan for the complete facility. As part of this plan, the management should decide how the building, its contents, and the occupants are to be protected during the rehabilitation process as well as when it is completed.

Regardless of the complexity or size of the project, management should collaborate with preservation architects, structural engineers, fire protection engineers, fire service representatives, risk management specialists, and others with experience and expertise in the design of fire protection systems and the historic building interface.

**B.3.2 Elimination or Control of Fire Safety and Life Safety Hazards.** The planning process for the rehabilitation of a historic structure should include provisions to control hazards that are not an inherent part of the historic fabric of the structure or its operation. Fire safety problems identified in the evaluation of existing conditions (*see Chapter 7*) should be ranked by priority to help identify the most undesirable conditions. These hazards might include life safety issues, such as exit facilities, as well as fire ignition and material combustibility considerations. Every effort should be made to eliminate as many identified hazards as possible.

Where a specific hazard is an essential part of the historic fabric of the building, the threat to the building and contents

should be controlled by providing special protection for the hazard. The approach taken can use any or a combination of the options discussed in Section 7.4.

As part of the elimination and control of fire hazards, a planned rehabilitation should be based on the building's inherent fire safety features and should not introduce new fire hazards. Alterations might change the conditions that previously have kept the building fire safe.

#### **B.4 Elements of a Fire Safety Plan.**

**B.4.1 Management Involvement.** Management involvement in fire safety planning is critical to successful program implementation. Management should consider the following four steps to ensure the fire safety of the historic property, both during and after the rehabilitation process:

- (1) Evaluate fully the existing conditions of the building.
- (2) Educate and train appropriate personnel in the importance and implementation of a sound fire prevention program and provide or have available trained, properly equipped fire-fighting and salvage organizations.
- (3) Institute management and operation practices that eliminate the cause of fire, both during and after the planned rehabilitation. Construction contracts should specify methods of control of combustibles and hazards, including measures such as those provided in NFPA 241.
- (4) Incorporate appropriate fire protection measures in the rehabilitation effort to limit damage if a fire occurs; appropriate measures include structural compartmentation, automatic detection and alarm, and fixed extinguishing systems.

#### **B.4.2 Prevention.**

**B.4.2.1 General.** During planning for the rehabilitation of a historic building, great care should be exercised to provide for the abatement of fire hazards throughout the construction period and following rehabilitation.

**B.4.2.2 Design.** To reduce the possibility of fire, existing fire safety standards such as *NFPA 70* and other NFPA and industry standards should be consulted during the design of electrical, mechanical, and similar systems.

**B.4.2.3 Education and Training.** For buildings that will be occupied during the rehabilitation process, staff members should be instructed to identify obvious fire hazards and to report them to a designated individual. Staff members also should receive hands-on training in the use of the fire suppression equipment provided. They should be instructed to report a fire and to evacuate the area before attempting to extinguish the fire. If this level of training is not practical for the entire staff, specific staff members should be designated for such training.

A fire response team or floor marshal plan can help organize specific staff members to react quickly to any fire emergency. Team members should be kept apprised of the rehabilitation work in progress and the possible hazards that will be introduced or will arise during construction.

**B.4.2.4 Operation and Maintenance.** Special precautions should be taken during the demolition and construction processes necessary to complete the rehabilitation project. (See Chapter 7 for a discussion of specific hazards and processes.)

**B.4.2.5 Enforcement.** The responsibility for enforcement of fire prevention measures should be clearly assigned and should include enforcement of the construction contract requirements relating to fire perils. Authority should be given to stop work pending correction of flagrant abuses. Responsible local authorities, such as fire and building departments, should be consulted.

#### **B.5 Limited Combustibility.**

**B.5.1 Construction Materials.** Careful consideration should be given to the use of fire-resistive materials and methods wherever they will not damage the structure's historic character. Use of these materials is especially important in concealed areas and other areas not exposed to the public.

Inert or fire-resistive materials should be used where appropriate, including in some cases where the structure is to be substantially rebuilt or where items used in original construction are unavailable. Ingenuity can inspire the selection of fire-safe components that simulate wood roofing and numerous other products. In some instances, the use of substitute materials for original wood might be appropriate. For example, rough-sawn wood can be duplicated in appearance by casting concrete in a mold or form that bears the marks that are desirable on the surface of the finished product, or wood shingles can be easily simulated with fire-resistant materials. Wood siding, wood shingles, and shakes that have been given a fire-retardant treatment are commercially available. Wood frame structural members and siding materials can be protected with spray-applied coatings or membrane-applied protection to enhance the fire resistance of the materials or assemblies where properly maintained. Even if community fire regulations and codes do not require the use of such materials, they should be considered.

Mechanical systems should be designed to minimize the use of combustible materials or lubricants. Noncombustible insulation materials should be used where such materials are to be installed.

Scaffolding and forms should be of noncombustible materials. Where noncombustible materials cannot be substituted, scaffolding and form lumber should be fire-retardant treated. Tarpaulins, if used, should be fire-retardant treated.

**B.5.2 Interior Finish Materials.** Choice of furnishings and interior finishes should be given careful consideration. For example, where highly combustible wood veneer paneling needs to be replaced, it might be appropriate to substitute a fire-resistive product. Fire-retardant-treated wood products used as interior finishes are readily available. Fire-resistant carpeting is available, and draperies of glass fiber or other fire-resistive materials should be considered.

Coatings are available that effectively reduce the surface **flame-spread** rating of many combustible materials. Although they do not render a material noncombustible, they significantly reduce the ease with which a material ignites. Such coatings should be considered whenever a noncombustible substitute is either unavailable or not suited to a particular application. Caution is necessary to avoid a coating that contains a chemical or other product that will damage or unacceptably alter the appearance of any historic material to which it is applied.

**B.5.3 Furnishings and Contents.** Noncombustible materials should be used as much as possible for furnishings and other



contents of the building. Where the intended occupancy of the building introduces combustible contents for which there are no substitutes, the building's fire loading should be considered when fire suppression systems are designed.

## B.6 Compartmentation.

**B.6.1 Horizontal Fire and Smoke Barriers.** The planning for the rehabilitation of a historic structure should consider the use of fire-rated walls and doors to subdivide building areas into separate fire areas and to segregate specific hazards, such as furnaces, boilers, or storage areas, from the remainder of the building. These fire-rated barriers should be designed to resist the passage of smoke. Other walls also should be designed to resist smoke passage and to confine the effects of a fire where possible. Such designs often can work to resist smoke passage and to confine the effects of a fire. Such designs often can be incorporated while maintaining the historic fabric and character of the structure.

**B.6.2 Vertical Enclosures.** Provisions should be made to enclose stairways, ventilation shafts, and other vertical openings with fire-rated construction to prevent the vertical spread of fire and smoke. Where the historic fabric of the building prevents such enclosures, alternative protection, such as sprinkler systems, should be provided.

**B.6.3 Firestops.** Firestops should be provided in concealed spaces to prevent the spread of fire within walls and between rafters and floor joists. Filling concealed spaces with inert material, such as mineral wool insulation or other similar fire-resistant materials, can further retard the spread of fire.

**B.7 Structural Protection.** The existing structural fire resistance should be determined wherever possible. For older structures, the U.S. Department of Housing and Urban Development has developed the *Guideline on Fire Ratings of Archaic Materials and Assemblies* (see Annex O), in their series of rehabilitation guidelines, to assist in identifying approximate fire resistance qualities of older construction methods and materials.

Wherever possible, new materials to be installed should be selected based on their ability to enhance the fire resistance of the basic structure. Gypsum wallboard, plaster, and other finish materials can improve the fire resistance rating of structural members if applied correctly.

Various types of fire detection and signal systems are described in Table D.2(a) through Table D.2(d).

**B.8 Fire Detection Systems.** Various automatic fire detectors can detect a fire condition from smoke, a critical item or rate of temperature rise, or infrared or ultraviolet radiation from the fire. These detectors can provide the warning needed to get people safely out of the structure, notify the fire department, and start fire-extinguishing action promptly. In buildings with automatic sprinkler systems, the fire detection system can provide a window of time for manual suppression by building occupants before detection and suppression by the automatic sprinkler(s) directly above the fire. Appropriate specialists should be consulted to determine which kinds of detectors best fit the conditions in different parts of the structure. (See Annex E, *Resources for Protection of Cultural Resource Property Projects*.)

Where it is determined that it is desirable to provide an opportunity for building occupants to employ manual fire

suppression before any sprinklers over the fire open, a separate early warning fire detection system should be considered that utilizes the detection device providing the fastest response with respect to the type of fire expected from combustibles in the occupancy.

Installed detection and alarm systems should not only sound an alarm within the structure but also transmit a signal to an alarm monitoring service or to a local fire department. Subsequent to an alarm, the fire department should be contacted immediately to verify that the alarm was received.

**B.8.1 Fire Detectors.** Fires produce heat, smoke, flame, and other signatures that detection systems recognize and to which they respond. Fire detectors are most typically designed to detect fire at a specific point in space (i.e., spot detectors), requiring a number of properly located units to cover a large area. Linear or line-type detectors (i.e., wires, pneumatic tubes, and photoelectric beams) often can be arranged to provide automatic detection less obtrusively and in unusual configurations. [See Table D.2(a) through Table D.2(d).]

**B.8.2 Heat Detectors.** Heat detectors are designed to respond when the operating element reaches a predetermined temperature (i.e., fixed-temperature detector), when the temperature rises at a rate exceeding a predetermined amount (i.e., rate-of-rise detector), or when the temperature of the air surrounding the devices reaches a predetermined level regardless of the rate of temperature rise (i.e., rate compensation detector). Heat detectors respond best to relatively large, high heat-producing fires.

**B.8.3 Smoke Detectors.** In almost every structural fire, measurable amounts of smoke are produced prior to measurable amounts of heat. Thus, smoke detectors are preferred for earlier warning of fire. Smoke detectors respond to the visible or invisible particulate matter produced in fires. Smoke detectors are available for spot placement, line-of-sight linear beam, and air sampling aspiration applications.

**B.8.4 Manual Alarm Boxes.** In some instances, a person discovers a developing fire prior to automatic detector operation. Manual alarm boxes should be provided to permit such a person to activate the building fire alarm system.

**B.8.5 Applications.** The primary function of an automatic detection system is to alert the occupants of a building to the presence of a fire. This can be especially important under the following conditions:

- (1) Large buildings where persons in one part of the building are not aware of a fire in another part
- (2) Buildings where a fire starts in an unoccupied area
- (3) Occupancies where there are a large number of people and significant time is required to evacuate
- (4) Situations where there are relatively long travel distances to exits
- (5) Buildings where the nature and arrangement of fuel make a fast-growing fire possible
- (6) Buildings that do not have sufficient barriers to limit the spread of fire and smoke
- (7) Residential occupancies

Automatic fire detection also performs the function of initiating the process of fire suppression by alerting trained occupants or the municipal fire service. Before any suppression can begin, a fire needs to be detected and suppression activated. This can be accomplished on site by individuals trained in

the use of fire extinguishers or by a properly equipped and staffed fire department. Fire size at detection affects the ability of manual suppression to activate.

**B.8.6 Design Considerations.** Expected fire size should be considered in the design of a fire detection system. (See NFPA 72.)

Where ceilings are 20 ft (6.1 m) or greater in height, it is imperative that engineering assistance be obtained. (See Annex E, *Resources for Protection of Cultural Resource Property Projects*.)

The design of fire detection systems also should consider normal combustion processes in the occupancy, to minimize false alarms. Attention should be given to activities that normally produce products of combustion (e.g., food preparation, automobile parking, smoking, steam, or aerosols).

Generally, system design should include detection throughout the entire building. Partial protection can result in a delayed response to a fire, causing larger losses.

## B.9 Fire Extinguishment.

**B.9.1 General.** An essential element in any fire safety plan is consideration of the means available to suppress a fire once it has begun. Management needs to make critical decisions as to the type of fire suppression capability that is provided in the building. Immediate response by operation of an automatic extinguishing system can be crucial in minimizing the damage to historic structures and their contents. Response by trained building personnel with appropriate extinguishing equipment also can minimize damage to historic structures and their contents. Operation of any of these systems should cause activation of an alarm at a constantly attended location or activation of the building alarm system as described in NFPA 101. The provision of these systems is equally important both during the rehabilitation process and afterward.

### B.9.2 Automatic Fire-Extinguishing Systems.

**B.9.2.1 General.** Automatic fixed fire-extinguishing systems are the most effective means of suppressing fires in buildings, and their use in historic buildings is recommended. They should be installed carefully to avoid damage to architectural and historic features and spaces.

Without some type of automatic extinguishing system, a fire will only increase in intensity until the fire department arrives. At that time, the fire department is faced with extinguishing a much larger fire than would have existed if an automatic extinguishing system had activated, and the damage resulting from extinguishing the fire in this manner would be substantially greater. For example, a fire department using one or more hose lines inside a building is capable of delivering water at a rate of 250 gal/min (946 L/min) per hose. Automatic sprinkler systems typically discharge water at a rate of 15 gal/min to 25 gal/min (57 L/min to 95 L/min) per sprinkler.

In general, it is considered good engineering practice to utilize total flooding gaseous systems only in combination with automatic sprinkler systems, rather than as an alternative. [See the NFPA Fire Protection Handbook; also see comparative design attributes in Table D.2(a) through Table D.2(d).] The combination of a total flooding gaseous system with an automatic sprinkler system provides a higher probability of confining fire growth to an area less than that typically covered by one sprinkler [e.g., 100 ft<sup>2</sup> (9.3 m<sup>2</sup>)]. The total flooding gaseous system becomes a

reliable substitute for manual suppression in the window of time between early warning detection and sprinkler operation.

The discharge of gaseous agents and dry chemicals is governed by automatic controls using smoke or heat detection devices. The various types of automatic extinguishing systems are described in Table D.2(d).

**B.9.2.2 Automatic Sprinkler Systems.** An automatic sprinkler system consists of a network of piping with sprinklers uniformly spaced along the piping to provide protection to a specified area or building. Water is supplied to the piping from a supply system, such as a municipal or private water distribution system. Effective operation is dependent on an adequate and dependable water supply.

Different types of sprinkler systems can be designed for specific areas. These include wet-pipe systems, dry-pipe systems, preaction systems, and deluge systems; all are discussed in Table D.2(d). Systems vary in method of operation and whether or not water is normally in the piping system. In most systems, only those sprinklers that are heated to the predetermined temperature operate; sprinklers in other areas remain closed. Typically, most fires are controlled by the operation of fewer than five sprinklers.

The potential for water damage from automatic sprinklers is often misunderstood. Some water damage occurs when sprinklers operate to control a fire. However, this damage is usually minimal compared to the amount of damage the fire would have caused if the sprinkler system had not controlled or extinguished it. Reports of water damage in sprinklered buildings are often exaggerated in comparison to the small amount of fire damage resulting from successful fire control by the sprinklers. Automatic sprinkler systems should be installed in accordance with NFPA 13.

**B.9.2.3 Halon 1301 Total Flooding Systems.** Halon 1301 is a colorless, odorless, electrically nonconductive gaseous agent that leaves no residue and requires no agent cleanup after discharge.

Halon 1301 extinguishing systems have been designed to protect rooms or other enclosures. They were often used successfully to protect occupancies with high-value contents susceptible to damage by other types of extinguishing agents.

Because of the deleterious effect that Halon 1301 and other chlorofluorocarbons (CFCs) have on stratospheric ozone, international agreements and the U.S. Environmental Protection Agency (EPA) have banned production of CFCs. However, Halon 1301 continues to be available for essential uses (for both new systems and for refilling existing systems) through recycling from nonessential uses. It is important that existing systems be serviced and maintained on a regular basis to avoid accidental discharges. Nevertheless, as reserves of Halon 1301 become scarce, this agent can be expected to become too expensive for most applications.

**B.9.2.4 Carbon Dioxide Systems.** Carbon dioxide extinguishes a fire by lowering the oxygen level below the 15 percent necessary for flame production. Personnel need to be evacuated before agent discharge to avoid suffocation and reduced visibility during and after the discharge period. Carbon dioxide systems should not be used in normally occupied areas.

**B.9.2.5 Clean Agent Systems.** Clean gaseous agents are electrically nonconductive, volatile gaseous fire extinguishants that do not leave a residue upon evaporation. These agents have been approved by the EPA as a substitute for Halon 1301. Clean agent systems consist of a supply of extinguishant in one or more containers and a nozzle(s) strategically placed in (throughout) the protected, enclosed space. The containers can be centrally located and connected to the nozzle(s) by a piping network or placed at various locations in or near the hazard, with each container connected directly to its nozzle or piped to one or more nozzles. The types of nozzles selected and their placement should be such that force of discharge will not adversely affect the building or room contents.

To be effective, most of these agents need to be tightly contained within the room being protected. The designer of the system needs to determine the extent of the protected volume's intensity. Clean agents are best suited for protecting the sensitive and delicate contents of a room, not the building structure. Total flooding fixed systems using gaseous agents depend on achieving and maintaining the concentration of the agent needed for effective extinguishment. Openings in the compartment (e.g., open windows or doors or ventilation systems that continue to operate) can prevent the achievement of an effective extinguishing agent concentration. Where a high reliability of operation is needed for protection of high-value collections, a backup system, such as an automatic sprinkler system in combination with a total flooding gaseous agent system, should be considered. The new clean agents, while similar to Halon 1301, may not be compatible with existing containers and other components.

It is good fire protection design practice to utilize total flooding gaseous systems in combination with, rather than as an alternative to, automatic sprinkler systems. [See the *NFPA Fire Protection Handbook*; also, see *comparative design attributes in Table D.2(d)*.] The combination of a total flooding gaseous system with an automatic sprinkler system provides a higher probability of confining fire growth to an area less than that typically covered by the operation of one sprinkler [e.g., 100 ft<sup>2</sup> (9.3 m<sup>2</sup>)]. The total flooding gaseous system becomes a reliable substitute for manual suppression in the window of time between early warning detection and sprinkler operation. Human response (e.g., occupant manual extinguishing action) is the least reliable means of fire suppression, especially considering those periods when the building is not occupied and is most vulnerable.

Explicit warning information and instructions for building occupants should be conspicuously posted. Similar precautions could be needed for other special extinguishing systems.

Clean agent systems are described in NFPA 2001.

## B.10 Manual Fire-Fighting Capability.

**B.10.1 Portable Fire Extinguishers.** Portable fire extinguishers are important items of fire protection equipment and should be installed in accordance with NFPA 10. Portable extinguishers allow the use of a limited quantity of extinguishing agent on a small fire at the moment the fire is discovered and, therefore, should be available in adequate numbers.

The extinguishers should be the type intended for the class of fire anticipated. Multiclass portable extinguishers are available that remove any doubt regarding the correct extinguisher to be used. Extinguishers should be properly located and

inspected regularly so that they are in working order when needed. Personnel should know the locations of the extinguishers and should be instructed in their use. It needs to be emphasized that the use of fire extinguishers should not delay the transmission of alarms to the fire department.

The selection and use of portable extinguishers should include the following health and safety considerations:

- (1) Gaseous agent-type extinguishers contain agents whose vapors can be toxic and whose decomposition products can be hazardous. Where these extinguishers are used in unventilated spaces, such as small rooms, closets, motor vehicles, or other confined spaces, operators and others should avoid breathing the gases produced by thermal decomposition of the agent. As in the case of total flooding gaseous suppression systems, production of halogenated extinguishing agents for portable extinguishers terminated on January 1, 1994, due to their ozone-depleting properties.
- (2) Carbon dioxide extinguishers contain an extinguishing agent that does not support life when used in sufficient concentration to extinguish a fire. The use of this type of extinguisher in an unventilated space can dilute the oxygen supply. Prolonged occupancy of such spaces can result in loss of consciousness due to oxygen deficiency.

(See NFPA 10.)

**B.10.2 Standpipe and Hose.** Where standpipes and hose lines are required or installed to provide reliable and effective fire streams in the shortest possible time, they should be installed in accordance with NFPA 14. Training and skill in the use of hose streams are essential to avoid injury and unnecessary property damage. Building occupants should not attempt to use fire hose unless they have been properly trained in accordance with safety recommendations and regulations (e.g., OSHA). It should be emphasized that the use of standpipe hose lines, as with the use of fire extinguishers, should not delay the transmission of alarms to the fire department. A waterflow alarm should be provided on a wet standpipe system.

**B.10.3 Hydrants and Outside Protection.** Where a municipal water system is part of a private water system with sufficient capacity and where pressure is available, fire hydrants should be provided to enable the fire department to quickly connect its pumpers and to lay hose lines to the building. Where possible, hydrants should be provided on all sides of the building. Care should be taken to avoid placing hydrants too close to the building so the fire department is not prevented from using a hydrant due to fire exposure from the building.

## Annex C Survey Criteria for a Historic Structure

*This annex is not a part of the requirements of this NFPA document but is included for informational purposes only.*

**C.1 Introduction.** Providing adequate fire protection to a historic building while protecting historic character can be a difficult task. The effort requires a thorough building survey by qualified professionals to identify critical historic elements, spaces, and features; restoration and preservation objectives; code deficiencies; and existing fire and life safety hazards. This survey provides the basis for all planning and design decisions and is essential for rehabilitation projects of all types, including those intended for original or existing uses and those that involve new uses.

## C.2 Identification of Historic Elements, Spaces, and Features.

**C.2.1 Exterior.** Exterior historic elements consist of those features outside the building that define the structure's character. These elements include the building's exterior construction, adjacent structures, and the site grounds.

**C.2.1.1 Construction Features.** Construction features include sheathing or facade materials, roofing materials, chimneys, skylights, cornices, windows and doors, and extensions such as porches, railings, and other attached building components. Major and minor facades should be studied so that, if exterior modifications or additions are necessary, they can be located on the least visible and least significant elevation in order to keep the impact to a minimum.

**C.2.1.2 Adjacent Structures.** Adjacent structures are those independent buildings and edifices that could have an effect on the historic building's mission and could affect or be affected by fire safety improvements. These structures could be part of or independent of the historic building site. Adjacent structures could include buildings, sheds, vehicles, and displays.

**C.2.1.3 Site Elements.** Site elements include exterior components that help define the historic building. These elements could affect or be affected by fire safety improvements. Site elements include vegetation, roads and driveways, walking paths, fencing, and exterior use.

**C.2.2 Interior.** Interior historic elements consist of those features within the building that are important in and of themselves, in conjunction with other features, or both. These elements include construction features, floor plans, and individual spaces.

**C.2.2.1 Construction Features.** Construction features are distinctive architectural details of significant form or historic function that are characteristic of the period. Historic fabric and spaces include those original to the building and changes to originals that have acquired significance in their own right. Specific elements can include wainscoting, parquet flooring, picture molding, mantels, ceiling medallions, built-in bookshelves and cabinets, crown molding, and arches, as well as simpler, more utilitarian features, such as plain windows and doors and associated trim. The significance of some architectural features could be that they are worked by hand, exhibit fine craftsmanship, or are particularly characteristic of the building style.

Some features can indicate later changes and alterations that have gained significance over time, such as lobby alterations, changes to wall and floor finishes, and later millwork.

**C.2.2.2 Floor Plans.** Floor plans can be an important characteristic of the building type, style, period of construction, or historic function. Even if the plan has been altered over time, it can have historic significance. For example, alterations that are additive (e.g., large rooms have been divided into smaller ones) rather than subtractive (e.g., walls have been removed) might be easily corrected to restore the building's integrity.

**C.2.2.3 Individual Spaces.** Significant spaces are rooms or other interior locations that are typical of the building type or style or are associated with specific persons or events.

The sequence of consciously designed spaces could be important to the understanding and appreciation of the building or original architecture. Examples of consciously designed spaces are a foyer opening into a large hall, front and rear

parlors connected by pocket doors, an office lobby opening into an elevator hall, and a hallway leading to a stairwell.

Spaces could have distinctive proportions, such as ceiling height to room size, or significant or unusual room shapes or volumes, such as rooms with curved walls, rooms with six or eight walls, or rooms with vaulted ceilings.

## C.3 Restoration and Preservation Objectives.

**C.3.1 Historic Documentation.** Relevant information might exist in the files of local or national historic organizations. If the historic resource is listed in a register or listing of historic places, a careful review of the official register nomination should be the first step in the building assessment. An understanding of why and when the individual building or historic district achieved significance helps in evaluating those spaces and features that are significant for their association with specific events or persons, architectural importance, or information potential.

In some cases, older register listings might neglect to describe all architectural spaces and features of the building's exterior and interior. Such omissions should not be construed to mean that the building possesses no character-defining elements. In such cases, professional preservation judgment can be of great assistance.

**C.4 Code Deficiencies: Code, Standard, and Regulation Compliance.** The evaluation of existing conditions should include a review of all safety-related requirements to determine if and where the codes might vary. Contact should be made with local fire and building authorities in order to determine the codes and standards in effect.

The code review will illustrate those areas of the building where code requirements are most stringent and where conflicts between code requirements and historic preservation concerns are most likely to occur. This review might assist in determining building use and designs that cause the least damage to historic character.

Typical code or safety deficiencies found in historic buildings might relate to construction, building systems, egress systems, use and occupancy, fire protection systems, and site concerns. Some deficiencies can be addressed readily without damage to the historic character of the building, while others require innovative solutions outside the strict compliance with codes and standards for new construction. Several of these deficiencies, with some solution options to assist in achieving compliance with fire safety code and standard objectives, are described in C.4.1 through C.4.6.

**C.4.1 Common Building Construction Deficiencies.** Common building construction deficiencies might include inadequate fire resistance of interior or exterior walls, insufficient interior compartmentation, deficient fire stopping, inadequate tenant separation, insufficiently protected combustible construction, excessive building height and fire area, and combustible materials or flammable finishes.

**C.4.2 Common Building System Fire Safety Deficiencies.** Common building system fire safety deficiencies might include inadequately sized mechanical and electrical systems; insufficient dampers; inadequate chimney design, height, or lining; and inappropriate mechanical or electrical enclosures.

**C.4.3 Typical Egress System Deficiencies.** Typical egress system deficiencies might include insufficient number of exits;

undersized exit route width; inadequate fire resistance of exit corridors, doors, or stairways; exit routes that do not lead directly to the exterior; dead-end corridors; excessive exit travel distance; inappropriate exit route configuration; and unenclosed monumental stairs.

**C.4.4 Building Use and Occupancy Code Deficiencies.** Building use and occupancy code deficiencies might include a use or occupancy not permitted in the particular construction type, incompatible uses, excessive or inappropriate human occupancy, and hazardous activities or processes.

**C.4.5 Fire Protection System Deficiencies.** Fire protection system deficiencies might include inoperative or insufficient automatic sprinkler protection; lack of manual fire-fighting systems (e.g., standpipes, fire extinguishers); inadequate water supply for fire protection use; insufficient smoke detectors, manual fire alarm stations, and audible alarms; lack of monitored fire detection, suppression, and alarm systems; and nonexistent or inadequate lightning protection.

**C.4.6 Site Concerns.** Site concerns might include inadequate separation distance between buildings, incompatible site uses, exterior fire hazards, and difficult access for fire-fighting vehicles.

**C.5 Existing Fire and Life Safety Hazards.** A fire hazard is a condition that might contribute to the start or spread of a fire or to the endangerment of people or property by fire. The general elements of fire hazards are ignition sources, combustibility of materials, and structural fire hazards.

**C.5.1 Ignition Sources.** Ignition is the initiation of combustion. It originates with the heating of a fuel by a heat source. When the temperature of the material is raised sufficiently, it begins to pyrolyze or decompose from heat into simpler substances, primarily combustible gases and vapors. Different substances are produced at varying rates and temperatures. When an adequate mass of combustible gases and vapors is mixed with oxygen or air and exposed to an energy source of sufficient intensity, ignition takes place.

Any form of energy is a potential ignition source. Most often the source is open flames or electrical wiring and appliances. Smoking, candles, solid-fuel heating, and similar combustion processes represent likely sources of ignition. Certain occupancies, such as restaurants and repair facilities, significantly increase the number and variety of heat sources. An example of a more unusual ignition source associated with historic buildings is the capacity of historic “bull’s-eye” glass to focus rays of the sun. (See Goldstone, “Hazards from the Concentration of Solar Radiation by Textured Window Glass.”)

**C.5.1.1 Electricity.** Inadequate electrical service and misuse of appliances are also common hazards. Electricity starts a fire when current flowing through a conductor encounters resistance, which generates heat. When the conductor is of proper size, this heat is dissipated. Excessive heat can be generated by overloads, arcing, faults, high resistance at poor connections, or lack of adequate cooling or heat dissipation.

Conditions leading to electrically caused fires most often involve wiring. A fire threat exists wherever protective wire insulation is damaged by heat, moisture, oils, vibration, impact, or operating conditions that result in loose connections.

Motors are the next most frequent source of electrical fire ignition. Motor fires result from electrical malfunction (e.g.,

faults, arcing, lightning surges), overheating, and bearing failure (e.g., from inadequate lubrication).

**C.5.1.2 Arson.** In recent decades, deliberately set fires have become a significant problem. Arson is a major threat to fire safety and always should be considered. Loss experience indicates that infrequently attended occupancies are the most frequent arson targets. Building storage areas offer large amounts of potential fuel and are usually unoccupied, conditions that are favorable for an arsonist. Mercantile and other public access areas are the next most frequent incendiary targets due to large amounts of combustibles and easy circulation.

**C.5.1.3 Smoking.** Smoking is a major cause of fire. Improperly handled and disposed-of cigarettes and matches present a threat that can be minimized by control and education. Where smoking is allowed, precautions should be enacted to minimize associated hazards. Total prohibition of smoking in a building could result in occupants smoking in hidden, combustible-filled areas.

**C.5.1.4 Overheated Materials.** Many processes use heated flammable liquids or baking, drying, or other high-temperature operations. Excessive overheating can lead to generation of flammable vapors and ignition of combustibles. Fires have been started by the hot surfaces of electrical equipment, piping, boilers, furnaces, ovens, dryers, flues, ductwork, and incandescent light bulbs. Heat conducted from such equipment can ignite adjacent combustibles. Friction in machinery components is also a potential cause of fire. Loose or worn moving parts rubbing against each other can generate enough heat to ignite nearby combustibles, such as lint and paper dust. Common friction sources include misaligned drive belts and worn or improperly lubricated bearings.

**C.5.1.5 Open Flames.** Improperly used open flames from portable torches, space heaters, cigarette lighters, and matches are a significant fire problem. In older structures, chimneys are particularly dangerous if not properly lined and pointed. Torches used for cutting, welding, soldering, and brazing can ignite adjacent combustibles. Space-heating equipment can be knocked over or used in close proximity to combustibles, resulting in fire.

**C.5.1.6 Exposures.** A building fire could start because of heat generated from a fire in a nearby structure, in yard storage, or in vegetation. Important factors include physical separation between exposed hazards, combustibility of the exposed building’s exterior, and the extent and protection of openings.

**C.5.1.7 Spontaneous Ignition and Chemical Reactions.** Chemical reactions can result in fires and explosions. Typical adverse reactions occur when chemicals react with other materials and when decomposition of unstable chemicals and hazardous processes are out of control.

Some materials undergo self-oxidation, giving off heat. When such materials are confined, more heat is generated than is dissipated, with ignition the likely result. Typical products subject to spontaneous ignition include rags or paper soaked in finishing, animal, and vegetable oils. Paint deposits containing drying oils can heat up and ignite.

**C.5.1.8 Lightning.** Fires can be started by direct lightning strikes and lightning-induced surges (i.e., overvoltage) in electrical circuits. The installation of lightning (surge) arresters on

power and communication lines where they enter structures is recommended and is covered in *NFPA 70*.

### C.5.2 Combustibility of Materials.

**C.5.2.1 Material Properties.** The tendency of a material to ignite is a function of its chemistry, physical state, surface texture, and moisture content. Different chemical compositions have different minimum temperatures at which they ignite. Ignition is a function of time as well as temperature. A potential fuel subjected to a relatively high temperature for a short period of time might not ignite, while the same fuel can undergo ignition when exposed for a longer duration to a lower temperature. For example, wood products have a normal ignition temperature of 400°F to 500°F (204°C to 260°C), but they have been found to ignite when subjected to a much lower heat source of 228°F (109°C) for 4 days. (See the *NFPA Fire Protection Handbook*.)

The contents of most buildings consist of combustible materials. Accumulations of readily ignitable items constitute a fire hazard. Construction materials, such as siding and roofing, can increase the possibility of fire spread from other buildings. This is especially true of wood shingles that are not fire-retardant treated.

**C.5.2.2 Flame Spread.** Combustibility is the principal factor contributing to the spread of flame across surfaces. Once ignition takes place, the flame heats surrounding material, causing it to ignite and thereby spread across the surface. The rate at which flame spread occurs is measured by test. (See *ASTM E84, Standard Test Method for Surface Burning Characteristics of Building Materials*, or *ANSI/UL 723, Standard for Test for Surface Burning Characteristics of Building Materials*.) Most building codes and *NFPA 101* place restrictions on the use of materials with high flame-spread rates.

A single layer of paint and most very thin wall coverings add little fuel to a fire. Even if paint or very thin wall coverings burn completely, only a small amount of heat is liberated and little damage results. On the other hand, the substrate on which the paint or paper is applied can have a great influence on flame spread. Paint on a metal ceiling might not ignite at all under fire exposure because the heat is dissipated by the metal.

Walls in older buildings might have been repeatedly painted or papered. Where multiple layers of paint and paper are present, flame spread can be significantly increased. There is a particular concern associated with partially peeling paint, which offers additional surfaces for flame spread and heat release.

The existence of interior wood paneling, as found in many historic structures, adds to the fuel and thereby increases flame spread. Combustible composition ceiling and wall materials and plastics in the form of high-density solids and expanded foam products also can contribute to flame spread. Flame spread in low-density cellulosic materials, used extensively in some older buildings for ceiling tile and wall panels, is likely to be rapid.

**C.5.2.3 Environmental Factors.** Sustained burning of the fuel material depends on its combustibility and on additional factors, such as interaction of surfaces, fluid flows, and thermal absorption. These factors are neither well defined nor predictable outside the laboratory. Observed conditions that produce these effects include arrangement of combustibles, wall materials, and room dimensions.

Furnishings and other combustibles that are close together cause fire to spread easily from one item to another. A fire starting in a corner can grow in size about four times faster than a fire in the middle of a room. Flame spread is much faster on vertical surfaces than on horizontal surfaces.

In general, fire develops more slowly in larger spaces. This is particularly true with respect to the height of the ceiling. A high ceiling is inherently more fire safe than a low colonial ceiling. Fires that can vent to the outside through windows or other means are slower to spread to other parts of a building.

**C.5.3 Structural Fire Hazards.** Structural features of buildings that constitute fire hazards are of two types: structural conditions that promote fire spread, either vertically or horizontally, and conditions that could lead to structural failure during a fire.

**C.5.3.1 Fire Spread.** Most buildings form a connected series of compartments. As such, they are inherently safer from fire if a fire can be contained to the compartment of origin. Unfortunately, design, construction, and use practices create many avenues for fire spread. For example, some construction can create virtual chimneys in the stud channels, allowing fire to spread the full height of the building. Paths of fire spread can be either horizontal or vertical.

**C.5.3.1.1 Means of Horizontal Fire Spread.** Means of horizontal fire spread include the following:

- (1) Doorways
- (2) Ceiling voids over walls
- (3) Floor cavities under walls
- (4) Utility and service chase-through walls
- (5) Voids in projecting eaves or cornices
- (6) Wall failure
- (7) Openings produced by distortion or failure of structural members in a fire
- (8) Open attic spaces and cocklofts
- (9) Corridors

**C.5.3.1.2 Means of Vertical Fire Spread.** Means of vertical fire spread include the following:

- (1) Stairways
- (2) Conduction of heat through the hearth slab to supporting timbers below
- (3) Wall cavities penetrating the floor
- (4) Utility and service chases penetrating the floor
- (5) Shafts for elevators, dumbwaiters, laundry chutes, and trash chutes
- (6) Breaching of the floor or ceiling by fire
- (7) Atriums
- (8) Windows or other exterior openings

**C.5.3.2 Structural Integrity.** The ability of structural framing to resist the effects of a severe fire is dependent on the framing material and its dimensions. Wood members, while combustible, might have a limited fire resistance, which depends on size, since fire resistance is a function of the surface-to-mass ratio of a member. Large-dimensional lumber, such as that used in heavy timber construction, provides significant endurance from the effects of fire. Studs and joists have little fire resistance, although older, fully dimensioned members are significantly better than modern thin-webbed or strap-hung construction. Steel, although noncombustible, is subject to decreased structural capacity at relatively low fire temperature.

Structural members can be protected to improve their resistance to fire.

#### C.5.4 Means of Egress.

**C.5.4.1 Occupant Evacuation.** Evacuation of occupants is the primary approach to life safety in the event of fire. Egress problems in exiting buildings generally arise with respect to number of exits, exit capacities, arrangement of exits, or construction details.

**C.5.4.2 Egress Codes.** NFPA 101 and most building codes detail specific requirements for ensuring adequate means of egress. NFPA 101 requires exits to be separated from other spaces of the building to provide a protected way of travel to a safe area.

**C.5.4.3 Number of Exits.** Codes specify the number of exits that must be provided for each floor as well as for the entire building. Minimum exit requirements are established to increase the reliability of the egress system. A minimum of two means of egress is a fundamental life safety principle, and codes permit few exceptions to this rule. The intent is that, for any single fire situation that prohibits travel to one exit, an alternate exit will be available. Additional exits might be required after consideration of the arrangement or capacity of exits.

**C.5.4.4 Exit Capacities.** Codes regulate the capacity of exits by establishing a relationship between the required width of various exit elements and the number of occupants they serve and by establishing minimum widths for each of the exit elements. It is the intent of the codes to provide an exit capacity large enough to move the total expected number of occupants into the safety of the exits before access to the exits becomes difficult.

**C.5.4.5 Exit Arrangement.** In addition to code requirements for exit number and capacity, codes generally require that exits be located to facilitate their use in a fire emergency. Requirements address remoteness, maximum travel distance, direct exit to the exterior, and maximum dead-end travel distance.

**C.5.4.6 Remoteness.** Codes generally require that exits are as remote from each other as practical and that they are arranged to allow direct access in separate directions. The intent of providing exit remoteness is to minimize the probability that access to all exits will be blocked by a single fire. The term *remote* is subjective and frequently is a matter of interpretation.

**C.5.4.7 Travel Distance.** Code requirements governing travel distance to an exit are intended to establish a maximum interval of time for an occupant to reach an exit. Travel distances are measured by mapping the path of travel to an exit. When combined with requirements for minimum number of exits and exit remoteness, the limitations on travel distance ensure that even if one exit is blocked by a fire, an occupant will be able to reach another exit or a location of refuge before the fire has spread in a manner that would prevent escape. The actual time for escape implied by maximum travel distance limitations is not explicitly stated in the codes.

**C.5.4.8 Dead-End Travel.** Dead-end corridors of any length are undesirable features in buildings for two reasons. First, people who use a dead-end corridor to reach an exit could be trapped by fire or smoke between themselves and the exit. Second, it is possible to mistakenly enter a dead-end corridor rather than an exit and, under smoky or poor light conditions, become trapped or confused.

**C.5.4.9 Egress Route Identification.** In general, exit routes must be clearly marked to assist occupants with evacuation path identification. During a fire emergency, visibility can become rapidly obscured by smoke and fire products. Rapid exit identification methods include exit signage, escape route diagrams, and emergency illumination.

**C.5.4.10 Construction Details.** Codes provide many requirements for the details of various exit components that make up a building's egress system. Typical areas covered include means of separation from other spaces, allowable materials, handrails, tread and riser design, landings, platforms, guards, door hardware, alarms, and lighting. The intent of these provisions is to ensure a quality design that promotes safe and easy passage. Individual code requirements tend to be numerous and highly specific.

### Annex D Basics of Fire and Fire Protection Systems

*This annex is not a part of the requirements of this NFPA document but is included for informational purposes only.*

**D.1 Classification of Fires.** Most fires that occur in cultural properties can be expected to fall into one or more of the following categories:

- (1) *Class A.* Fires involving ordinary combustible materials, such as paper, wood, and textile fibers, where a cooling, blanketing, or wetting extinguishing agent is needed
- (2) *Class B.* Fires involving oils, greases, paints, and flammable liquids, where a smothering or blanketing action is needed for extinguishment
- (3) *Class C.* Fires involving live electrical equipment, where a nonconducting gaseous clean agent or smothering agent is needed

**D.1.1 Fire Detection and Alarm Systems.** Technology is available to customize a fire detection system for the particular needs of specific properties. Early detection of fires affords the opportunity of occupant intervention and potentially faster response by automatic fire suppression.

**D.2 Glossary of Fire Protection Systems.** Table D.2(a) through Table D.2(d) describe detection, alarm, and extinguishing systems that are appropriate for use in cultural properties. Included are comments about the intended or optimum applications of each system and recommendations for system applications. Insofar as possible, nontechnical terminology has been used so that the information presented can be readily understood by anyone who has been delegated responsibility for fire safety.

**Table D.2(a) Classification of Fire Detection Systems by Method of Detection**

Type	Description	Comments
1. Smoke detection systems	<p>Systems that use devices that respond to the smoke particles produced by a fire. They operate on the ionization, photoelectric, cloud chamber, or other smoke particle analysis principle of operation. Spot-type smoke detectors use either the ionization principle of operation or the photoelectric principle. Line-type smoke detectors use the photoelectric principle. Aspiration-type smoke detectors use the ionization, photoelectric, cloud chamber, or other particle analysis principle of operation.</p> <p>Properly installed, smoke detectors can detect smoke particles in very early stages of fire in the areas where they are located. The selection of a particular detector or mix of detectors should be based on building and fire-load conditions and made by a fire protection specialist.</p>	<p>These systems are intended for early warning. Some are designed for installation in ventilation ducts. (See <i>NFPA 72</i>.)</p>
2. Heat detection systems	<p>Systems that use heat-responsive devices of either the spot or line type. They are mounted either on exposed ceiling surfaces or a sidewall near the ceiling. Heat detectors are designed to respond when the operating element reaches a predetermined temperature (fixed-temperature detector), when the temperature rises at a rate exceeding a predetermined value (rate-of-rise detector), or when the temperature of the air surrounding the device reaches a predetermined level, regardless of the rate of temperature rise (rate compensation detector).</p> <p>Some devices incorporate both fixed-temperature and rate-of-rise detection principles. Spot-type detectors are usually small devices a few inches in diameter. Line-type detectors are usually lengths of heat-sensitive cable or small-bore metal tubing.</p>	<p>These systems are relatively low cost. They cannot detect small, smoldering fires. Line-type detectors can be installed in a relatively inconspicuous manner by taking advantage of ceiling designs and patterns. (See <i>NFPA 72</i>.) The air temperature surrounding a fixed-temperature device at the time it operates usually is considerably higher than the rated temperature, because it takes time for the air to raise the temperature of the operating element to its set point, a condition called thermal lag.</p> <p>Rate compensation devices compensate for thermal lag and respond more quickly when the surrounding air reaches the set point. Given the monetary value and irreplaceable nature of typical museum collections, early-warning, air-sampling-type detector systems should be considered for optimum protection. These systems are also less conspicuous and minimize disruption to architectural integrity. Proper selection of a particular detector or a mix of detectors should be based on building and fire-load conditions and made by a fire protection specialist.</p>
3. Flame detection systems	<p>Systems that use devices that respond to radiant energy visible to the human eye (approximately 4000 to 7000 angstroms) or to radiant energy outside the range of human vision [usually infrared (IR), ultraviolet (UV), or both]. Flame detectors are sensitive to glowing embers, coals, or actual flames with energy of sufficient intensity and spectral quality to initiate the detector.</p>	<p>Because flame detectors are essentially line-of-sight devices, special care should be taken in their application to ensure that their ability to respond to the required area of fire in the zone that is to be protected is not unduly compromised by the permanent or temporary presence of intervening structural members or other opaque objects or materials. (See <i>NFPA 72</i>.)</p>



**Table D.2(b) Classification of Fire Alarm Systems by Method of Operation**

Type	Description	Comments
1. Local fire alarm system	An alarm system operating in the protected premises that is responsive to the operation of a manual fire alarm box, waterflow in a sprinkler system, or detection of a fire by a smoke-, heat-, or flame-detecting system.	The main purpose of this system is to provide an evacuation alarm for the occupants of the building. Someone must always be present to transmit the alarm to fire authorities. <i>(See NFPA 72.)</i>
2. Auxiliary fire alarm system	An alarm system that utilizes a standard municipal fire alarm box to transmit a fire alarm from a protected property to municipal fire headquarters. These alarms are received on the same municipal equipment and are carried over the same transmission lines as are used to connect fire alarm boxes located on streets. Operation is initiated by the local fire detection and alarm system installed at the protected property.	Some communities accept this type of system and others do not. <i>(See NFPA 72 and NFPA 1221.)</i>
3. Central station fire alarm system	An alarm system that connects protected premises to a privately owned central station and that monitors the connecting lines constantly and records any indication of fire, supervisory, or other trouble signals from the protected premises. When a signal is received, the central station takes such action as is required, such as informing the municipal fire department of a fire or notifying the police department of intrusion.	This is a flexible system. It can handle many types of alarms, including trouble within systems at protected premises. <i>(See NFPA 72.)</i>
4. Remote station fire alarm system	An alarm system that connects protected premises over telephone lines to a remote station, such as a fire station or a police station. It includes separate receivers for individual functions being monitored, such as fire alarm signal or sprinkler waterflow alarm.	<i>(See NFPA 72.)</i>
5. Proprietary fire alarm system	An alarm system that serves contiguous or noncontiguous properties under one ownership from a central supervising station at the protected property. It is similar to a central station system but is owned by the protected property.	This system requires 24-hour attendance at a central supervising station. <i>(See NFPA 72.)</i>
6. Emergency voice/alarm communication system	A system used to supplement any of the systems listed above by permitting voice communication throughout a building so that instructions can be given to building occupants. During a fire emergency, prerecorded messages can be played, fire department personnel can transmit live messages, or both.	<i>(See NFPA 72.)</i>

**Table D.2(c) Classification of Fire Detection and Alarm Systems by Type of Control**

Type	Description	Comments
1. Conventional system	A fire detection system that utilizes copper wire to interconnect all initiating devices and signaling appliances to the fire alarm control panel. The wiring must be installed in a closed-loop fashion for each zone circuit to ensure proper electrical supervision or monitoring of the circuit conductors for integrity.	This is the most common type of fire alarm system. It provides basic alarm, trouble, and supervisory signal information and is used for small- to medium-size systems.
2. Microprocessor-based system	Identical to the conventional system, with the exception that the fire alarm control panel has more features available, such as smoke detector alarm verification and system walk test. Some of these systems “multiplex” information to their attached remote annunciators over four conductors rather than one conductor per zone.	Most modern systems are microprocessor-based to provide features desired by installers, owners, and fire departments.
3. Addressable multiplex system	A system that utilizes initiating devices and control points, each assigned a unique three- or four-digit number called the detector’s “address.” The fire alarm control panel’s microprocessor is programmed with the address number. All activity by or affecting the device is monitored and recorded at the control panel.	This type of system provides more detailed information about alarm, trouble, or supervisory conditions. Essentially, the system is zoned by device rather than by an entire floor or area. The equipment for addressable multiplex systems is more costly, but, generally, installation costs are reduced substantially, operations are more flexible, and maintenance is more efficient.
4. Addressable analog multiplex system	Identical to the addressable multiplex system, with the exception that the smoke and heat detectors connected to the microprocessor are analog devices.  The analog devices sense the fire signature and continuously send information to the control panel microprocessor, which determines the sensitivity, alarm point, and maintenance window of the analog device. Accordingly, this system is also called “intelligent” or “smart.”	Analog systems provide the maximum flexibility and information that can be obtained from a fire alarm system. These computer-based systems require sophisticated technical expertise to maintain and service which should be considered in the design process. Addressable fire detection systems allow for the execution of preprogrammed sensitivity levels for smoke detectors based on the time of day or days of the week, ranging from a low-sensitivity level when the premises are occupied to a high-sensitivity level when only employees are present or the protected premises are vacant.
5. Wireless system	A system that uses battery-powered initiating devices, which transmit the alarm or trouble signal to a receiver/control panel. Each initiating device can be individually identified by the control panel for annunciation purposes.	The battery in each initiating device lasts for a minimum of 1 year but needs to be replaced when the initiating device transmits a battery depletion signal to the control panel. Wireless systems can be used where it is not possible or feasible to install the electrical cable needed by hard-wired systems.

△ Table D.2(d) Glossary of Fire-Extinguishing Systems

Type	Description	Comments
1. Wet-pipe automatic sprinkler system	A permanently piped water system under pressure, using heat-actuated sprinklers. When a fire occurs, the sprinklers exposed to the high heat operate and discharge water individually to control or extinguish the fire.	This system automatically detects and controls fire. It should not be installed in spaces subject to freezing and might not be the best choice in spaces where the likelihood of mechanical damage to sprinklers or piping is high, such as in low-ceiling areas, and could result in accidental discharge of water. Where there is a potential for water damage to contents, such as books, works of art, records, and furnishings, the system can be equipped with mechanically operated on-off or cycling heads to minimize the amount of water discharged ( <i>see type 3</i> ). In most instances, the operation of only one sprinkler will control a fire until the arrival of fire fighters. Often the operation of a sprinkler system will make the use of hose lines by fire fighters unnecessary, thus reducing the amount of water put onto the fire and the subsequent amount of water damage. ( <i>See NFPA 13 and NFPA 22.</i> )
2. Preaction automatic sprinkler system	A system that employs automatic sprinklers attached to a piping system containing air that might or might not be under pressure, with a supplemental fire detection system installed in the same area as the sprinklers. Actuation of the fire detection system by a fire opens a valve that allows water to flow into the sprinkler system piping and to be discharged from any sprinklers that are opened subsequently by the heat from the fire.	This system automatically detects and controls fire. It can be installed in areas subject to freezing. Because it minimizes the accidental discharge of water due to mechanical damage to sprinklers or piping, it is useful in areas where system leaks would pose a hazard for works of art, books, records, and other materials susceptible to damage or destruction by water. Such water damage is rare, however, resulting in only 1.6 accidental discharges per year per 1 million sprinklers in use. Failure of the actuation system would prevent operation of the preaction sprinkler system, except by manual operation of the water supply valve, and thus presents a potential failure mode that reduces the reliability of this system compared with wet-pipe systems. Furthermore, a preaction system requires a significantly higher level of regular maintenance, involving additional potential failure modes that further reduce its reliability relative to wet-pipe systems. Most water-sensitive items can be salvaged from wetting but not from ashes. ( <i>See NFPA 13 and NFPA 22.</i> )
3. On-off automatic sprinkler system	A system similar to the preaction system, except that the fire detector operation acts as an electrical interlock, causing the control valve to open at a predetermined temperature and close when normal temperature is restored. If the fire rekindles after its initial control, the valve reopens, and water again flows from the opened sprinklers. The valve continues to open and to close in accordance with the temperature sensed by the fire detectors. Another type of on-off system is a standard wet-pipe system with on-off sprinklers. Here, each individual sprinkler is equipped with a temperature-sensitive device that causes the sprinkler to open at a predetermined temperature and to close automatically when the temperature at the sprinkler is restored to normal.	In addition to the favorable feature of the automatic wet-pipe system, these systems have the ability to automatically stop the flow of water when no longer needed, thus eliminating unnecessary water damage. ( <i>See NFPA 13 and NFPA 22.</i> )
4. Dry-pipe automatic sprinkler system	A system that employs automatic sprinklers attached to a piping system containing air under pressure. When a sprinkler operates, the air pressure is reduced, thus allowing the dry-pipe valve to open and to allow water to flow through any opened sprinklers.	<i>(See type 1.)</i> This system can protect areas subject to freezing. Water supply must be in a heated area. ( <i>See NFPA 13 and NFPA 22.</i> )
5. Standpipe and hose system	A piping system in a building to which hoses are connected for emergency use by building occupants or by the fire department.	This system is a desirable complement to an automatic sprinkler system. Staff must be trained to use hose effectively. ( <i>See NFPA 14.</i> )

(continues)

△ Table D.2(d) *Continued*

Type	Description	Comments
6. Gaseous automatic system	A system that uses gaseous extinguishing agents, including Halon 1301, carbon dioxide, and new clean agents, which have been approved as replacements for Halon 1301. (Halon 1301 is no longer manufactured due to its deleterious effect on the ozone layer.) These systems are permanently piped using a measured, stored supply of a gaseous extinguishing agent under pressure and discharge nozzles to totally flood an enclosed space. The extinguishing agent is released automatically by a suitable early warning detection system. The systems extinguish fire by chemical or mechanical means.	Clean agents are low in toxicity, but the products of decomposition of some agents during a fire can be hazardous. These products are kept to an acceptable limit by the systems' ability to detect a fire in its incipient stage and to discharge the agent before decomposition products can attain harmful levels. It should be noted that products of combustion of the fire are considerably more hazardous. Therefore, the fire area should be promptly evacuated upon sounding of a fire alarm prior to agent discharge. Clean agents might not extinguish deep-seated fires in ordinary solid combustibles, such as paper and fabrics, but are effective on surface fires in these materials. An early warning detection system, which releases the agent in the fire's incipient stage, should extinguish the fire before it can become deep-seated. These systems need special precautions to avoid damaging effects caused by their extremely rapid release. The high-velocity discharge from nozzles might be sufficient to dislodge objects directly in the path. Where carbon dioxide systems are used, personnel should evacuate immediately upon sounding of a fire alarm, before agent discharge, to avoid suffocation. (See NFPA 12, NFPA 12A, and NFPA 2001.)
7. Dry chemical system	A permanently piped system that discharges a dry chemical from fixed nozzles by means of an expellant gas. The system either totally floods an enclosed space or applies the dry chemical directly onto the fire in a local application. The dry chemical extinguishes fires by the interaction of the dry chemical particles to stop the chain reaction that takes place in flame combustion. The dry chemical is released mechanically or with a suitable detection system.	This system leaves a powdery deposit on all exposed surfaces in and around the hazard being protected, which requires cleanup. This type of system provides excellent protection from a fire when installed in the ducts and hood over cooking equipment such as deep fat fryers, range griddles, and broilers that could be a source of ignition. It might not extinguish deep-seated fires but is effective on surface fires. (See NFPA 17.)
8. High-expansion foam system	A fixed extinguishing system that generates a foam agent for total flooding of confined spaces and for volumetric displacement of vapor, heat, and smoke. It acts on fire in the following ways: (1) Prevents free movement of air (2) Reduces the oxygen concentration at the fire (3) Cools The foam agent is released automatically by a suitable detection system.	Where personnel might be exposed to a high-expansion foam discharge, suitable safeguards should be provided to ensure prompt evacuation of the area. The discharge of large amounts of high-expansion foam can inundate personnel, blocking vision, making hearing difficult, and creating some discomfort in breathing. It also leaves residue and requires cleanup. Properly designed, high-expansion foam used in conjunction with water sprinklers provides more positive control and extinguishment than either extinguishment system used independently. (See NFPA 11.)
9. Wet chemical extinguishing system	A system that operates in the same way as halon systems (see type 6), except that it uses a liquid agent usually released by automatic mechanical thermal linkage. It is effective for restaurant, commercial, and institutional hoods, plenums, ducts, and associated cooking appliances.	This system leaves agent residue that is confined to the protection area(s) and requires cleanup. Excellent for service facilities having range hoods and ducts. (See NFPA 17A.)
10. Fine water mist system	In general, a piped system or modular, pressurized container system that delivers a fine water mist and that has a water droplet size ranging to a maximum 1000 µm.	

## Annex E Resources for Protection of Cultural Resource Property Projects

*This annex is not a part of the requirements of this NFPA document but is included for informational purposes only.*

**E.1 Introduction.** A fire protection consultant can be a valuable resource in evaluating the current status of fire safety for a cultural property and in recommending creative solutions to improve fire safety and achieve fire safety goals. To realize the maximum benefit from engaging a fire protection consultant, the consultant's qualifications and the client's needs should be properly matched. The consultant should have qualifications equivalent to member grade in the Society of Fire Protection Engineers (SFPE).

The consultant's experience should be evaluated, both as a company and as individual consultant team members, in providing fire protection consulting services to libraries. Other experience that might also be considered is that for historic buildings or structures and museums.

The consultant's experience should also be compared with the nature of the work to be performed and the size of the project being considered. As a final factor for evaluation of experience, whether the specific team proposed has worked together and the degree to which the experience is team experience should be considered.

Other factors that should be used in evaluating a consultant's qualifications are membership and participation in organizations such as NFPA; the American Institute of Architects (AIA), for registered architects; the National Society of Professional Engineers (NSPE), for registered engineers; and the model building code organizations. Participation on committees of these organizations is a further measure of the consultant's understanding of library fire safety issues.

After information on the fire protection consultant's qualifications has been collected, references should be contacted to determine how the consultant has actually performed on similar projects.

**E.2 NFPA.** National Fire Protection Association, 1 Batterymarch Park, Quincy, MA 02169-7471.

NFPA publishes this document and related documents on fire protection and will answer inquiries on these documents. The association also conducts educational seminars, studies, and literature searches for a fee.

NFPA maintains a list of fire protection consultants.

**E.3 SFPE.** Society of Fire Protection Engineers, 9711 Washingtonian Blvd, Suite 380, Gaithersburg, MD 20878.

SFPE is a professional society of fire protection engineers that meets annually, publishes technical information, conducts technical seminars, and supports local chapters. Members are located in all parts of the world. Names and addresses of

members in a particular geographic area can be obtained from society headquarters.

**E.4 NICET.** National Institute for Certification in Engineering Technologies, 1420 King Street, Alexandria, VA 22314.

NICET certifies technicians in the following areas of fire protection:

- (1) Automatic sprinkler system layout
- (2) Special hazards system layout (i.e., automatic and manual foam-water, halon, carbon dioxide, and dry chemical systems)
- (3) Fire detection and alarm systems

People with a NICET certification can also assist in the selection and use of fire protection systems. NICET provides certification for four levels of competence in all three of the listed areas of fire protection.

**E.5 UL.** UL LLC, 333 Pfingsten Road, Northbrook, IL 60062-2096.

UL has a certification service through which alarm companies can be qualified to issue certificates stating that installed fire warning systems comply with NFPA standards and are properly tested and maintained. A list of alarm service companies authorized to issue UL certificates is available. UL also publishes safety standards and annual directories of labeled and listed products and fire-resistant assemblies.

**E.6 AIA.** American Institute of Architects, 1735 New York Ave. NW, Washington, DC 20006-5292. [www.aia.org](http://www.aia.org)

The Historic Resources Committee (HRC), which is one of the AIA Knowledge Communities, has a mission to identify, understand, and preserve architectural heritage, both nationally and internationally. HRC promotes the role of historic architects as leaders in historic preservation activities by offering an array of knowledge delivery in preservation practice, technology, and education. Members monitor and manage the balance between philosophical ideals and business realities, and serve as liaisons to a variety of allied professional preservation organizations, agencies, and programs.

HRC is engaged in promoting within the profession through the development of information and knowledge among members, allied professional organizations, and the public. With sustainability as a buzzword and an increased portion of an architect's work on existing structures, preservation has moved into the mainstream of our community, cultural, and economic interests. The goals of HRC include the following:

- (1) To offer expertise in historic architecture to allied and liaison preservation organizations
- (2) To teach the value of preservation as design, and to develop case studies in best practices for components and other organizations
- (3) To enhance standards of practice for preservation architects

## Annex F Examples of Compliance Alternatives

*This annex is not a part of the requirements of this NFPA document but is included for informational purposes only.*

**▲ F.1 General.** Direct compliance with prescriptive codes is still the predominant means of ensuring fire safety in historic buildings. Most codes include provisions for equivalent protection by means other than those prescribed in the code. The following examples illustrate ways that preservation goals have been met through carefully designed fire protection that complied with prescriptive code provisions or through equivalency-based solutions that appropriately addressed safety deficiencies in a specific application.

Equivalency provisions allow alternative designs to satisfy regulations if they provide a level of fire safety equivalent to that called for by the regulations. As stated in 3.3.23, an equivalency approach is “an alternative means of providing an equal or greater degree of safety than that afforded by strict conformance to prescribed codes and standards.”

There is no single acceptable method of providing appropriate fire safety. Each historic building is unique, requiring that equivalencies be assessed in relation to the particular circumstances of the historic structure and occupancy. What may be appropriate for one building may not be appropriate for another, and it cannot be assumed that the following solutions will apply to every situation. The intent of these examples is to illustrate context-sensitive design for achieving fire safety goals in historic properties.

**F.2 Means of Egress.** Figure F.2(a) shows a common fire safety problem in historic buildings. The main monumental stairway in this historic building is the primary access and exit route between the main lobby and the upper floors. The open stair is a key architectural feature but could provide a path of fire and smoke migration that would render the route unusable. Figure F.2(b) through Figure F.2(d) illustrate solutions to this problem.

Figure F.2(b) illustrates an egress enclosure solution that involved retrofitting existing historic glazed doors that enclose egress stairs with rated ceramic glass. Part of this process involved evaluating several fire performance tests on the stair door assembly.

Figure F.2(b) illustrates an original door retrofitted with 0.25 in. (7 mm) glass. The glass withstands the fire duration, and because the building is sprinkler protected, the hose stream test was waived for this installation.

The door is normally held open to permit normal occupant movement through the space. This is accomplished by magnetic devices on the floor that release and close the door when the fire alarm activates. The wall panel on the left that covers the retracted door was painted to match the adjoining historic marble.

The example illustrated in Figure F.2(c) involved the need to provide separation where multiple egress paths converged into a single evacuation point that had the potential to become obstructed during a fire. To resolve this situation, accordion-type cross-corridor doors were installed, thereby enabling the preservation of dozens of bronze and glass corridor doors that would have been absorbed into a larger egress path. These doors are normally open out of the visitor’s view. However, if a fire is detected, these doors close to create a fire separation.

The accordion door tracks, pocket, and cover were painted to match the surrounding veined marble and elaborate coffered ceiling. (Another example of a Won Door application is shown in Figure F.2(d), which illustrates a unit in a partially closed position.)

The accordion door and track in Figure F.2(c) have been carefully concealed and color-matched to minimize visual impact. The wall panel on the left that covers the retracted door was painted to match the adjoining historic marble.

Figure F.2(d) illustrates an accordion door closing to protect a monumental stairway. Under normal conditions, the door is concealed in a wall pocket on the left side of the opening. When a smoke detector identifies a developing fire, a signal is sent to the building fire alarm, which in turn closes the Won Door to prevent fire spread via the stair.

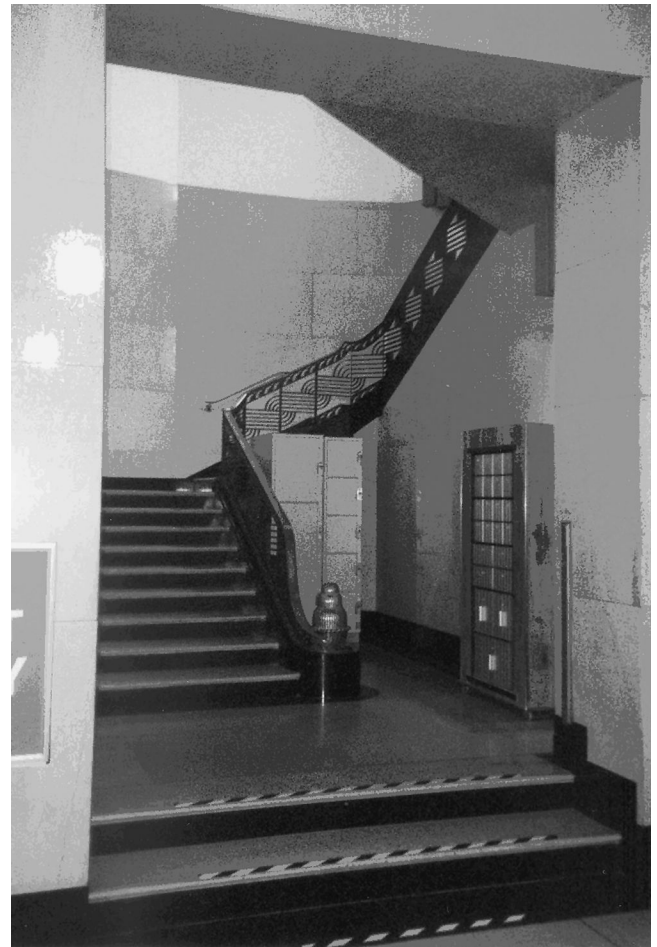

**FIGURE F.2(a) Open Monumental Stair.**



**FIGURE F.2(b) Rated Glass Corridor Doors in Normal Position.**

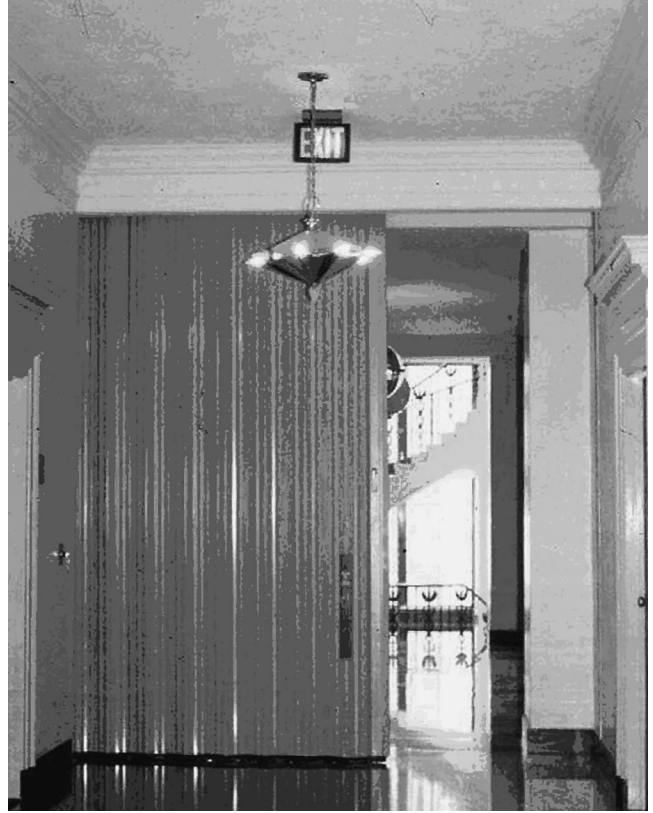

**FIGURE F.2(d) Won Door in a Partially Closed Position.**



**FIGURE F.2(c) Won Door in an Open Position.**

**F.3 Automatic Fire Suppression Systems.** Figure F.3(a) illustrates the use of sprinklers to cool the window assembly during fire exposure. Tests conducted in 1984 by the National Research Council of Canada (NRC) for the atrium of the Toronto, Ontario Hospital for Sick Children (NRC Test CBD-248) demonstrated that when properly wetted by sprinklers, standard glazed windows can provide an effective barrier.

To retain the historic frame and ornamental glazing, the sprinkler in Figure F.3(a) was placed to cool the window assembly during fire exposure.

Figure F.3(b) illustrates automatic fire suppression utilizing water sprays, or mists, to accomplish fire control. Water mist occurs when water is subjected to high pressure ranging from approximately 100 to 1000 psi (6.8 to 68.5 bar) and forced through extremely small orifices. This results in very fine droplets that have a higher heat absorption capability than larger sprinkler drops, enabling fire suppression with approximately 10 percent to 20 percent of the water normally required for sprinklers. Mist may also be an effective radiant heat blocker, which prevents thermal energy from damaging adjacent contents and building features. Currently, water mist nozzles do not offer the same coverage ranges available with sprinklers and are often limited to rooms with a maximum ceiling height of 16 ft (5 m). This results in decreased flexibility in the placement of mist nozzles, but as new nozzle technologies are introduced this difference is expected to diminish.

Figure F.3(b) shows a water mist system in operation during a fire test. Note the fog-like appearance of the sprays, which have millions of fine droplets to overcome the fire's heat.

Figure F.3(a) through Figure F.3(e) illustrate sprinkler piping and heads sensitively placed for minimal visibility and architectural impact. Ideally, all piping should be concealed, but this is not always possible because of the structural, architectural, and financial implications of constructing new enclosures in historic spaces that may contain ornamental ceilings or contoured surfaces.

The sprinkler pipe in the vaulted ceiling shown in Figure F.3(c) was placed along the cornice at the base of the vault. Color-matched sidewall sprinklers were placed to allow proper water spray.

The pipes that serve the sprinkler heads shown in Figure F.3(d) were placed behind the beam, concealing them from the normal line of sight.

Figure F.3(e) shows the sprinkler piping for the fire sprinklers in Figure F.3(d).

In Figure F.3(f) shows the sprinkler head carefully placed in the center of the decorative ceiling rosette to minimize the visual impact.



**FIGURE F.3(a) Sprinklers to Maintain Glass Cooling.**



**FIGURE F.3(b) Water Mist Discharge.**

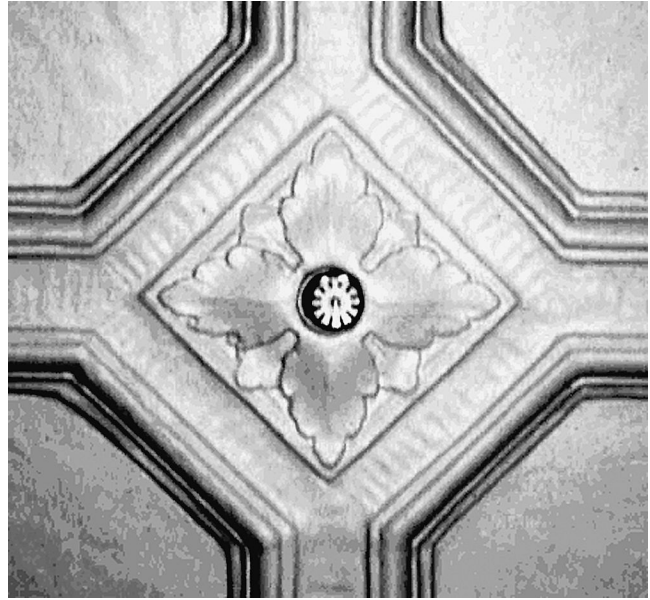

**FIGURE F.3(c) Exposed Sprinkler Pipe.**

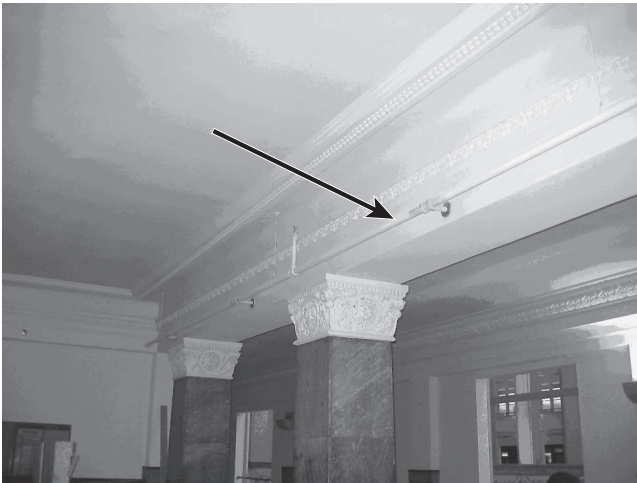



**FIGURE F.3(d) Sprinkler Piping Concealed from Normal View.**



**FIGURE F.3(f) Sprinkler in Rosette.**



**FIGURE F.3(e) Sprinkler Piping Out of Normal Sight.**

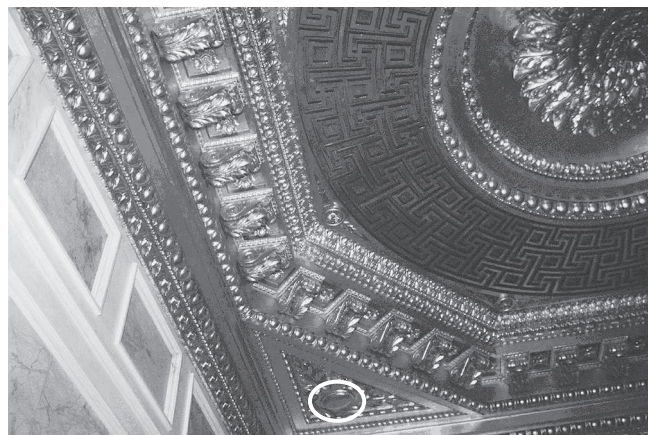

**FIGURE F.4(a) Color-Matched Smoke Sensor.**

**F.4 Fire Detection Systems.** Figure F.4(a) through Figure F.4(c) illustrate aesthetically integrated smoke sensors. The selection of a system and its components is dependent on the type and size of building, characteristics of the occupants, anticipated fire growth, and aesthetic and historic fabric issues.

Figure F.4(a) shows a smoke sensor that was color matched to the ornate ceiling. The sensor was disassembled by the manufacturer to permit factory painting of the cover and then reassembled, avoiding damage to the sensing components.

Figure F.4(b) and Figure F.4(c) illustrate projected, or linear, beam-type sensors. These sensors consist of two separate components: a transmitter that projects a narrow light beam and the corresponding optical receiver that monitors the intensity of the light. In certain installations, the transmitter and the receiver are in the same housing with a reflector at the other end of the space. The main advantage of projected beam detection over spot sensors is that it can cover larger areas without placing numerous sensors along the ceiling. Such an arrange-

ment is ideally suited for aesthetically significant open spaces where numerous spot sensors would otherwise be required.

Figure F.4(b) shows a large historic room protected by a set of linear beam smoke detectors. The transmitter and the receiver are placed on opposite walls, avoiding the placement of detectors on the ceiling assembly. A beam detector transmitter and receiver can typically be set up to 300 ft (100 m) apart.

The projected beam smoke detector in Figure F.4(c) transmits a narrow light beam to a similar appearing receiver on the opposite wall.

Figure F.4(d) illustrates how the required manual fire alarm box was mounted on a bollard, avoiding the need to cut into the historic wall materials.



**FIGURE F.4(b) Linear Beam Smoke Detector Protected Room.**



**FIGURE F.4(c) Linear Beam Smoke Detector.**

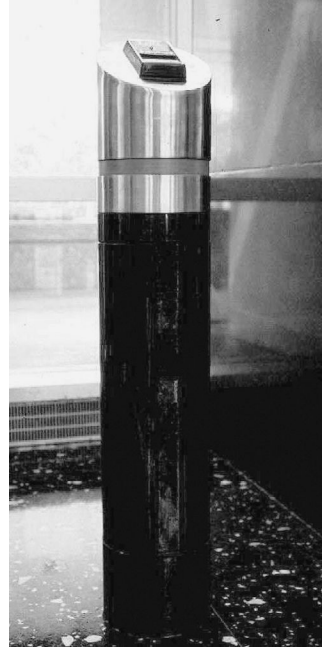

**FIGURE F.4(d) Bollard-Mounted Fire Alarm Box.**

**Annex G Performance-Based Fire Safety Code Compliance.**

*This annex is not a part of the requirements of this NFPA document but is included for informational purposes only.*

**G.1 General.** Chapter 9 of this code provides requirements for the evaluation of a performance-based life safety and fire protection design. The evaluation process is summarized in Figure G.1.

**G.1.1 Code Criteria.** On the left side of Figure G.1 is input from the code. The life safety and historic preservation goals are stated in Section 4.2, and the objectives necessary to achieve those goals are stated in Section 4.3. Section 9.2, Performance Criteria, specifies the measures that are to be used to determine whether the objectives have been met.

**G.1.2 Input.** At the top of Figure G.1 is the input necessary to evaluate a fire safety design.

**G.1.3 Design Specifications.** The design specifications need to include certain retained prescriptive requirements as specified in Section 9.3. All assumptions about the life safety design, fire safety design, and the response of the building and its occupants to a fire must be clearly stated, as indicated in Section 9.4. Scenarios are used to assess the adequacy of the design. Eight sets of initiating events are specified for which the ensuing outcomes need to be satisfactory.

**G.1.4 Performance Assessment.** Appropriate methods for assessing performance are to be used per Section 9.6. Safety factors need to be applied to account for uncertainties in the assessment, as stated in Section 9.7. If the resulting predicted outcome of the scenarios is bound by the performance criteria, then the objectives have been met and the fire safety design, coupled with the goal of maintaining the historic character of

the building under evaluation, is considered to be in compliance with this code. Although not part of this code, a design that fails to comply can be changed and reassessed, as indicated on the right side of Figure G.1.

**G.1.5 Documentation.** The approval and acceptance of a fire safety design depend on the quality of the documentation of the process. Section 9.8 specifies the minimum set of documentation that needs to accompany a submission.

**Δ G.2** The performance option of this code establishes acceptable levels of risk to occupants of buildings and structures, as addressed in Section 4.2. These risks are also used to evaluate the degree or extent to which the proposed designs will alter or affect the historically significant features of the property. While the performance option of this code does contain goals, objectives, and performance criteria necessary to provide an acceptable level of risk to occupants, it does not describe how to meet the goals, objectives, and performance criteria. Design and engineering are needed to develop solutions that meet the provisions of this chapter. The *SFPE Engineering Guide to Performance-Based Fire Protection* provides a framework for these assessments. Other useful references include the *Australian Fire Engineering Guidelines* and the *British Standard Firesafety Engineering in Buildings*.

**Annex H Methods to Determine Untenable Conditions**

*This annex is not a part of the requirements of this NFPA document but is included for informational purposes only.*

**H.1 General.** Four methods can be used to avoid exposing occupants to untenable conditions:

- (1) Prevent incapacitation by fire effects
- (2) Ensure full evacuation prior to untenable conditions
- (3) Contain effects of smoke and toxic gas
- (4) Contain all fire effects

**Δ H.2 Prevent Incapacitation by Fire Effects.** The design team could set detailed performance criteria that would ensure that occupants are not incapacitated by fire effects. The *SFPE Engineering Guide to Performance-Based Fire Protection* describes a process of establishing tenability limits. That guide references D. A. Purser, who in the *SFPE Handbook of Fire Protection Engineering* describes a fractional effective dose (FED) calculation approach (see also *NFPA 269*). FED addresses carbon monoxide, hydrogen cyanide, carbon dioxide, hydrogen chloride, hydrogen bromide, and anoxia effects. It is possible to use the test data, combined with laboratory experience, to estimate what FED would lead to the survival of virtually all people. That value is approximately 0.8.

There is a relationship between exposures leading to death and those leading to incapacitation. Kaplan found that rodent susceptibility is similar to that of humans, and that for the narcotic gases (carbon monoxide and hydrogen cyanide), human incapacitation occurs at one-third to one-half the lethal exposure. Gann found that carbon monoxide dominates the lethality of fire smoke, since most fire deaths occur remote from the fire room and from fires that have proceeded past flashover. Thus, if the FED value of 0.8 were used for a nonlethal exposure, an FED of 0.3 would be reasonable for a nonincapacitating exposure.

If the AHJ or the design professional is concerned with potential toxic fire effects other than those addressed by the FED procedure as documented, the calculation procedure can

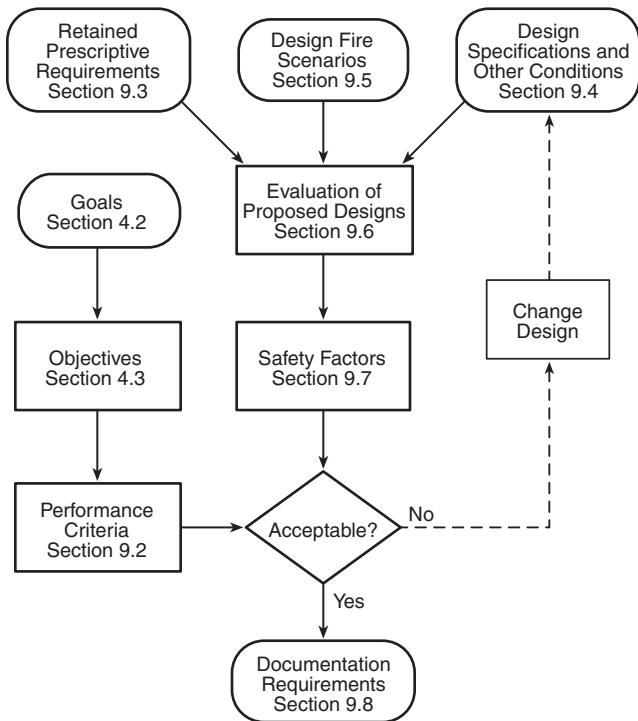

**Δ FIGURE G.1 Performance-Based Fire Safety Code Compliance Process. [101:A.5.1.1]**

be expanded by adding additional terms to the FED equation, where each term has the form of a ratio. The numerator of the ratio is the cumulative exposure to that fire effect, measured as an integral of the product of instantaneous exposure (concentration for toxic products) and time. The denominator of the ratio is the quantity of cumulative exposure for which FED equals the chosen threshold value (e.g., 0.8 or 0.3) based on that fire effect alone.

The American Society for Testing and Materials (ASTM) is actively considering standards that would extend the list of toxic fire effects with standard values.

If the authority having jurisdiction or the design professional is concerned with potential fire effects other than toxicity, the calculation procedure can be modified to include other fire effects, such as thermal effects.

For buildings where an unusually large fraction of the occupants would be especially vulnerable, the calculation procedure should be modified to use FED values lower than those cited above.

**H.3 Full Evacuation Prior to Untenable Conditions.** For each design fire scenario and the design specifications, conditions, and assumptions, the design team could demonstrate that each room or area would be fully evacuated before the smoke and toxic gas layer in that room descended to a level lower than 6 ft (1.8 m) above the floor. This procedure requires that no occupant would be exposed to fire effects. It requires calculation of the locations, movement, and behavior of occupants, because it keeps fire effects and occupants separate by moving the occupants. A level of 6 ft (1.6 m) is often used in calculations, but with that level, a large fraction of the population would not be able to stand, walk, or run normally and still avoid inhalation of toxic gases. They would have to bend over or otherwise move their heads closer to the floor level.

**H.4 Containment of Effects of Smoke and Toxic Gas.** For each design fire scenario and the design specifications and assumptions, the design team could demonstrate that the smoke and toxic gas layer will not descend to a level lower than 6 ft (1.8 m) above the floor in any occupied room. The advantage of this procedure is that it conservatively requires that no occupant would be exposed to fire effects, regardless of where occupants were or where they moved. This option removes the need to make any calculations regarding occupants, including their behavior, movement locations, pre-fire characteristics, and reactions to fire effects. This procedure is even more conservative and simpler than the procedure in Section H.2, because it does not allow fire effects in occupied rooms to develop to a point where people could be affected even after there are no people present to be affected.

**H.5 Containment of All Fire Effects.** For each design fire scenario and the design specifications and assumptions, the design team could demonstrate that no fire effects would reach any occupied room. The advantage of this procedure is that it removes the need to make any calculations regarding occupants, including their behavior, movement, locations, pre-fire characteristics, and reactions to fire effects. A further advantage is that it also removes the need for some of the modeling of fire effects, because it is not necessary to model the filling of rooms, only the spread of fire effects to those rooms. This is even more conservative and simpler than the procedures in H.2 and H.3, because it does not allow any fire effects in occupied rooms.

## Annex I Assessment Methods

*This annex is not a part of the requirements of this NFPA document but is included for informational purposes only.*

**▲ I.1 General.** The *SFPE Engineering Guide to Performance-Based Fire Protection* outlines a process for evaluating whether trial designs meet the performance criteria during the design fire scenarios.

Procedures described in Sections 9.2 and 9.4 identify required design fire scenarios within which a proposed fire safety design needs to perform and the associated untenable conditions that need to be avoided in order to maintain life safety. Additionally, this same process should be used to establish the level of tolerance that specific contents, building features, or both, can sustain without incurring irreparable damage. This annex discusses methods that form the link from the scenarios and criteria to the goals and objectives.

**I.2 Assessment Methods.** Assessment methods are used to demonstrate that the proposed design will achieve the stated goals and objectives by providing information indicating that the performance criteria of Section 9.2 can be adequately met. Assessment methods can be either tests or modeling.

**I.2.1 Tests.** Test results can be directly used to assess a fire safety design when they accurately represent the scenarios developed by using Section 9.4 and when they provide output data matching the performance criteria in Section 9.2. Because the performance criteria for this code are stated in terms of human exposure to lethal fire effects, no test suffices. However, tests are needed to produce data for use in models and other calculation methods. Likewise, there are few specific data regarding the impact of smoke, heat, and flame on dated fabric, materials, and construction materials. When possible, anecdotal information, tests on like materials, or both can be necessary to establish credible damage limits on these materials.

Subsections I.2.1.1 through I.2.1.6 provide further information on types of tests and uses of data.

**I.2.1.1 Standardized Tests.** Standardized tests are conducted on various systems and components to determine whether they meet some predetermined, typically prescriptive, criteria. Results are given on a pass/fail basis: either the test specimen does or does not meet the pre-established criteria. The actual performance of the test specimen is not usually recorded.

**I.2.1.2 Scale.** Tests can be either small scale, intermediate scale, or full scale. Small-scale tests are used to test activation of detection and suppression devices and the flammability and toxicity of materials. Usually, the item to be tested is placed in the testing device or apparatus. Intermediate-scale tests can be used to determine the adequacy of system components (e.g., doors and windows, as opposed to entire systems). The difference between small scale and intermediate scale is usually one of definition provided by those conducting the test. Full-scale tests typically are used to test building and structural components or entire systems. The difference between intermediate scale and large scale is also subject to the definition of those performing the test. Full-scale tests are intended to most closely depict performance of the test subject as installed in the field (i.e., most closely represent real-world performance).

Full-scale building evacuations can provide information on how the evacuation of a structure is likely to occur for an exist-

ing building with a given population but without subjecting occupants to the real physical or psychological effects of a fire.

**I.2.1.3 Data Uses.** The data obtained from standardized tests have three uses for verification purposes:

- (1) The test results can be used instead of a model. This typically is the role of full-scale test results.
- (2) The test results can be used as a basis for validating the model. If the model predictions match well with the test results, the model can be used in situations similar to the test scenario.
- (3) The test results can be used as input to models. This typically is the use of small-scale tests, specifically flammability tests.

**I.2.1.4 Start-Up Test.** Start-up test results can be used to demonstrate that the fire safety system performs as designed. The system design can be based on modeling. If the start-up test indicates a deficiency, the system needs to be adjusted and retested until it can be demonstrated that the design can meet the performance criteria. Typically, start-up tests apply only to the installation to which they are designed.

**I.2.1.5 Experimental Data.** Experimental data from nonstandardized tests can be used when the specified scenario and the experimental setup are similar. Typically, experimental data are applicable to a greater variety of scenarios than are standardized test results.

**I.2.1.6 Human and Organizational Performance Tests.** Certain tests determine whether inputs used to determine human performance criteria remain valid during the occupancy of a building. Tests of human and organizational performance might include any of the following:

- (1) Measuring evacuation times during fire drills
- (2) Querying emergency response team members to determine whether they know required procedures
- (3) Conducting field tests to ensure that emergency response team members can execute tasks within predetermined times and accuracy limits (Design proposals should include descriptions of any tests that are needed to determine whether stated goals, objectives, and performance criteria are being met.)

**I.2.2 Modeling.** Models can be used to predict the performance criteria for a given scenario. Because of the limitations on use of tests alone for this purpose, models are expected to be used in most, if not all, performance-based design assessments.

Fire models do not model fires; they model the effects of a [user-] specified fire (i.e., a heat release rate curve is input). For ease of use, the term *fire model* is used in this discussion instead of the more accurate *fire effects model*.

The effects of fire and its toxic products on the occupants can be modeled, as can the movement and behavior of occupants during the fire incident. The term *evacuation model* is used to describe models that predict the location and movements of occupants, and the term *tenability model* is used to describe models that predict the effects on occupants of specified levels of exposure to fire affects. The term *exposure model* is used to describe models that replicate the movement of smoke and heat and tell how smoke and heat can potentially affect the fabric of the material or content.

Subsections I.2.2.1 through I.2.2.4 provide further information on fire models.

For additional information on selecting, verifying, validating, and documenting the use of fire models, see the *SFPE Guidelines for Substantiating a Fire Model for a Given Application*.

**I.2.2.1 Types of Fire Models.** Fire models are used to predict fire-related performance criteria. Fire models can be either probabilistic or deterministic. Several types of deterministic models are available: computational fluid dynamics (CFD), or field, models, zone models, purpose-built models, and hand calculations. Probabilistic fire models are also available, but they are less likely to be used for this purpose.

Probabilistic fire models use the probabilities as well as the severity of various events as the basis of evaluation. Some probabilistic models incorporate deterministic models, but this is not a requirement. Probabilistic models attempt to predict the probability and severity associated with an unwanted fire (e.g., likelihood of an expected loss), which can be thought of as the probability-weighted average severity across all possible scenarios. Probabilistic models can be manifested as fault or event trees or to other system models that use frequency or probability data as input. These models tend to be manifested as computer software, but this is not a requirement. Furthermore, the discussion in Section I.3 can also be applied to probabilistic models, although that section concentrates on deterministic models.

CFD models provide the most accurate predictions of all the deterministic models because they divide a given space into thousands of smaller volumes. However, they are still models and as such are not absolute in their depiction of reality. In addition, they are much more expensive to use because they are computationally intensive. Because of their expense, complexity, and intensive computational needs, CFD models require much greater scrutiny than do zone models. It is much more difficult to provide multiple runs of CFD models to check sensitivity to a variety of factors such as design fire cell resolution or ventilation.

Zone models are more widely used than CFD models because they provide reasonably accurate predictions in much less time. It is easier to assess sensitivity of different parameters with zone models, because they generally run much faster and the output is much easier to interpret. Prediction of fire growth and spread has a large number of variables associated with it; consequently, the zone models with their crudeness and speed have advantages over the more complex CFD models.

Purpose-built models (also known as stand-alone models) are similar to zone models in their ease of use. However, purpose-built models do not provide a comprehensive model; instead, they predict the value of one variable of interest. For example, a specific purpose-built model could predict the conditions of a ceiling jet at a specified location under a ceiling, while a zone model would approximate fire conditions throughout a zone (specified area) of the enclosure.

Purpose-built models might or might not be manifested as computer software. Those that are not manifested as such are referred to as hand calculations. These purpose-built models are, therefore, simple enough that the data management capabilities of a computer are not necessary. Many of these calculations are found in the *SFPE Handbook of Fire Protection Engineering*.

**I.2.2.2 Types of Evacuation Models.** Three categories of evacuation models can be considered: single-parameter estimation

methods, movement models, and behavioral simulation models.

Single-parameter estimations are generally used for simple estimates of movement time. They are usually based on equations derived from observations of movement in non-emergency situations. They can be hand calculations or simple computer models. Examples include calculation methods for flow times based on widths of exit paths and travel times based on travel distances. Sources for these methods include the *SFPE Handbook of Fire Protection Engineering* and the *NFPA Fire Protection Handbook*.

Movement models generally handle large numbers of people in a network flow similar to water in pipes or ball bearings in chutes. They tend to optimize occupant behavior, resulting in predicted evacuation times that can be unrealistic and far from conservative. However, they can be useful in an overall assessment of a design, especially in early evaluation stages, where an unacceptable result with this sort of model indicates that the design has failed to achieve life safety objectives.

Behavioral simulation models take into consideration more of the variables related to occupant movement and behavior. Occupants are treated as individuals and can have characteristics assigned to them uniquely, allowing a more realistic simulation of the design under consideration. However, given the limited availability of data for the development of these models, for their verification by their authors, or for input when using them, their predictive reliability is questionable.

**I.2.2.3 Tenability Models.** In general, models will be needed here only to automate calculations over time-of-exposure effect equations referenced in A.9.2.2.1.

**I.2.2.4 Other Models.** Models can be used to describe combustion (as noted, most “fire models” characterize only fire effects), automatic system performance, and other elements of the calculation. Few models are in common use for those purposes, so they are not described further here.

**I.3 Sources of Models.** Compendia of computer fire models are found in Olenick and Carpenter’s “An Updated International Survey of Computer Models for Fire and Smoke.” That reference contains models that were developed by the Building Fire Research Laboratory of the National Institute of Standards and Technology and that can be downloaded from the Internet at <http://www.bfrl.nist.gov/864/fmabs.html>. Evacuation models in all three categories are discussed in the *SFPE Handbook of Fire Protection Engineering* and the *NFPA Fire Protection Handbook*.

**I.4 Validation.** Models undergo limited validation. Most can be considered demonstrated only for the experimental results they were based on or the limited set of scenarios to which the model developers compared the model’s output.

The model user must rely on the available documentation and previous experience for guidance regarding the appropriate use of a given model. For more information on the verification and validation of fire models, see the *SFPE Guidelines for Substantiating a Fire Model for a Given Application*.

The design professional should present the strength of the evidence presented for the validity, accuracy, relevance, and precision of the proposed methods. The authority having jurisdiction, when deciding whether to approve a proposal, should consider those data as well. An element in establishing the

strength of scientific evidence is the extent of external review and acceptance of the evidence by peers of the authors of that evidence.

Models have limitations, and most are not user friendly; therefore, experienced users will be able to construct more reasonable models and better interpret output than novices. It is for those reasons that the third-party review and equivalency sections are provided. These statements are not meant to discourage the use of models but rather to indicate that they need to be used with caution and by those well versed in their nuances.

**I.5 Input Data.** The first step in using a model is to develop the input data.

The heat release rate curve specified by the user is the driving force of a fire effects model. If this curve is incorrectly defined, the subsequent results are not usable. In addition to the smoldering and growth phases that are specified as part of the scenario definition, two additional phases are needed to complete the input heat release rate curve: steady burning and burnout.

Steady burning is characterized by its duration, which is a function of the total amount of fuel available to be burned. In determining the duration of this phase, the designer needs to consider how much fuel is assumed to be consumed in the smoldering and growth phases and how much is assumed to be consumed in the burnout phase that follows. A common assumption is that the burnout phase is the mirror image of the preceding phases, with a reversed heat release rate curve and the same amount of fuel consumed in the burnout phase as in the growth phase. Depending on the assumptions made regarding the amount of fuel consumed during burnout, the time at which this phase starts should be easy to determine.

Bear in mind that the preceding discussion assumes that the burning objects are solid (e.g., table, chairs). If liquid or gaseous fuels are involved, the shape of the curve will be different. For example, smoldering is not relevant for burning liquids or gases, and the growth period is very short, typically measured in seconds. [Peak heat release rate depends primarily on the rate of release, on the leak rate (gases and liquid sprays), or on the extent of spill (pooled liquids).] The steady burning phase is once again dependent on the amount of fuel available to burn. Like the growth phase, the burnout phase is typically short (e.g., closing of a valve), although it is conceivable that longer times can be appropriate, depending on the extinguishment scenario.

Material properties are needed (usually) for all fuel items (initial and secondary), as well as the enclosure surfaces of involved rooms or spaces.

For all fires of consequence, it is reasonable to assume that the fire receives adequate ventilation. If there is insufficient oxygen, the fire will not be sustained and will go out. An overabundance of oxygen is only a concern in special cases (e.g., hermetically sealed spaces), when a fire does not occur due to dilution of the fuel (i.e., a flammable mixture is not produced). Therefore, given that the scenarios of interest can occur in nonhermetically sealed enclosures, it is reasonable to assume that adequate ventilation is available and that if a fire starts it will continue to burn until it either runs out of fuel or is extinguished by other means. The only variable that would need to be assumed is the total vent width.

Maximum fire extent is affected by two geometric aspects: proximity of a burning object to walls and overall enclosure dimensions.

Conservatively, when a fire is considered to be “against a wall” or “in a corner,” the effective heat release of the fire can be doubled and quadrupled, respectively. For the burning object to be considered against the wall or in the corner, it needs to be either touching the enclosure surface or within 2 in. (50.8 mm). The reasoning behind this convention is that a wall effectively cuts the fire plume in half, while a corner results in one-quarter of the plume if the burning object is closer to the center of the room. Conceptually, the same amount of combustible vapors is produced, regardless of the burning object’s position, but the presence of walls or corners results in a smaller volume in which to burn them. In other words, walls and corners effectively concentrate the flammable vapors resulting from pyrolysis of the fuel.

The room dimensions affect the time required for a room to reach flashover. Simply stated, for a given amount and type of fuel under the same ventilation conditions, a small room will reach flashover before a large room will. In a large room with a small amount of fuel, a fire will behave as if it is outside (i.e., with adequate oxygen to burn and no concentration of heat). If the fuel package is unchanged but the dimensions of the room are decreased, the room will begin to have an affect on the fire (assuming adequate ventilation). The presence of the [relatively smaller] enclosure results in the buildup of a hot layer of smoke and other products of combustion under the ceiling. This in turn feeds more heat back to the seat of the fire, which results in an increase in the pyrolysis rate of the fuel and thus increases the amount of heat energy released by the fire. The room enclosure surfaces themselves also contribute to this radiation feedback effect.

Probabilistic data are expressed as either a frequency (units of inverse time) or a probability (unitless but applicable to a stated period of time). An example of the former is an expected number of failures per year, and the range of the latter is between 0 and 1, inclusive. Probabilities can be either objective or subjective. Subjective probabilities express a degree of belief that an event will occur. Objective probabilities are based on historical data and can be expressed as a reliability (of a component, system, etc.).

### Annex J Fire Safety Inspection Forms

*This annex is not a part of the requirements of this NFPA document but is included for informational purposes only.*

**J.1 Monthly Fire Protection Self-Inspection Checklist.** The following checklist should be used as a reminder during inspections. Items requiring corrective action should be reported on a Notice of Fire Hazard form. (See Figure J.1.)

X Satisfactory      0 Correction required      /Not applicable

#### Life Safety

- Ability to use exit doors is not hampered by security measures during occupancy.
- Stairwell and hallway fire doors are kept in the closed position.

(continues)

- Stairwells and evacuation routes are free and clear of obstructions.
- Fire escape stairs appear to be in good condition.
- Emergency lighting units operate when tested.
- Exterior emergency exit routes are clear and free from snow and ice.
- Illuminated exit signs are all lit, not blocked, and can be easily seen.

#### Fire Protection Equipment

- Portable fire extinguishers are in their proper location and fully charged and tagged.
- A space of at least 18 in. (457 mm) is kept between sprinklers and materials.
- Fire hose cabinets are in good order, easily visible, and accessible.
- Fire detectors are free from obstructions.
- Sprinkler control valves are open and locked or secured, and dry pipe systems register at normal air pressures.
- Sprinkler tanks, piping, and supports appear in good condition.
- Alarm systems function and are tested regularly.
- Lightning arresters appear in good condition.

#### Housekeeping and Storage

- Rubbish is not left to accumulate in excessive quantities; trash receptacles are emptied daily.
- Storage areas are kept clean and orderly; cleaning materials are safely stored.
- Combustible materials are not kept in unprotected areas such as a crawlspace.
- Roof scuppers and drains are unobstructed. Roof covering is in good condition.
- Aisles are unobstructed.

#### Hazardous Liquids

- Emergency measures are posted in case of accidental spills.
- Flammable/combustible liquids are kept in approved safety containers.
- Flammable/combustible liquids are stored in an approved cabinet.
- Safety storage cabinet vents are clear of obstructions.
- Soiled rags are kept in an approved self-closing waste container.
- Portable fire extinguishers are in their place and of the proper type.

#### Exhibits/Collections/Book Stacks

- Exhibits and collections are not overcrowded.
- Exhibit case lights do not show signs of overheating.
- Exhibits are not blocking exit routes or access to fire protection equipment.
- Extension cords are not used.
- All vertical and horizontal openings in fire barriers are firestopped.
- Salvage equipment and materials are provided and accessible.

(continues)

- The fire department is familiar with and has access to these areas.
- Smoking regulations are enforced with employees and visitors.
- Temporary wiring conforms with *NFPA 70*.

**Auditoriums and Classrooms**

- Safe capacity is posted and enforced.
- Standing and sitting in aisles are prohibited.
- Smoking regulations are enforced.

**Restaurants and Eating Areas**

- Safe capacity is posted and enforced.
- Aisles and exit routes are unobstructed and illuminated.
- Ranges, hoods, and exhaust ducts are clean.

**Shops/Laboratories/Packing Areas**

- Laboratory wastes are disposed of daily, using appropriate precautions.
- Spray coating facilities are safely ventilated, and scrubbers and filters are clean.
- Electrical equipment in areas near where flammable liquids are in use are explosionproof.
- Electrical appliances have warning lights and are unplugged when not in use.
- Employees are aware of special hazards and trained in necessary special precautions.
- Entry is limited to authorized persons.
- Power tools and machines are grounded.
- Woodworking equipment dust collectors are functioning adequately and collector bins emptied regularly.
- Power tools are unplugged when not in use.

**Exterior and Environment**

- All exits, emergency exits, and fire escapes afford unobstructed passage to a safe area.
- Grounds surrounding the facility are clear of accumulations of combustible material and brush.
- Fire service access is maintained clear.
- Fire hydrants and sprinkler system siamese connections are visible, accessible, and operable.

**Personnel/Training**

- All staff members know how to transmit a fire alarm.
- All emergency team members have received training and are aware of their assigned duties.
- All staff members have received training in the use of portable extinguishers and fire prevention.

**Building Changes Since Last Inspection**

- Do not interfere with fire detection or fire suppression systems.
- Do not contribute unreasonable fire loading.
- Do not create vertical and horizontal openings in fire-rated walls and ceilings.

**Notice of Hazard Forms**

- Items requiring action have been noted on Notice of Hazard forms. (*See Figure J.1.*)

Area inspected: \_\_\_\_\_  
 Inspected by: \_\_\_\_\_  
 Date of inspection: \_\_\_\_\_

**NOTICE OF FIRE HAZARD**

**DATE REPORTED:** \_\_\_\_\_ **HAZARD CONTROL NO.:** \_\_\_\_\_

**AREA WHERE HAZARD WAS NOTICED:** \_\_\_\_\_

**THE FOLLOWING HAZARD WAS NOTICED:**

\_\_\_\_\_

\_\_\_\_\_

\_\_\_\_\_

\_\_\_\_\_

**THE POTENTIAL RISK IS AS FOLLOWS:**

\_\_\_\_\_

\_\_\_\_\_

\_\_\_\_\_

\_\_\_\_\_

**THE FOLLOWING ACTION IS RECOMMENDED:**

\_\_\_\_\_

\_\_\_\_\_

\_\_\_\_\_

**Reported to:** \_\_\_\_\_ **Reported by:** \_\_\_\_\_

(print name) (print name)

**FIGURE J.1 Form for Reporting Fire Hazards Requiring Corrective Action.**



## Annex K Fire System Maintenance Checklists

*This annex is not a part of the requirements of this NFPA document but is included for informational purposes only.*

**K.1 Maintenance of Automatic Sprinkler and Standpipe Systems.** Each alarm, dry pipe, preaction, and deluge valve should have maintenance tags (annual, 5-year, 50-year, and so forth) attached for recording the inspector's initials, date, pressure readings, and confirmation on maintenance/inspections performed on the system. Checklists detailing maintenance should be kept by the office responsible for maintenance. All problems noted should be corrected before initialing the maintenance tag.

During any renovation or inspection of an automatic sprinkler system, the following should be reported for the facility manager for correction:

- (1) Sprinklers that are damaged, blocked by storage, painted, or otherwise impaired. (Construction, occupancy changes, and changes to heating, lighting, and air-conditioning systems might require relocating, adding, or replacing sprinklers.)
- (2) Pipe hangers with mechanical injury and corrosion.

### General Requirements for All Sprinkler and Standpipe Systems

- Annually, inspect water pressure and air pressure gauges to make sure they are within normal range. Investigate a loss of pressure of more than 10 percent. Record new pressure readings on the attached tag.
- Annually, inspect control valve labels to ensure they are accurate. Replace missing signs and relabel inaccurate signs.
- Annually, inspect fire department connections to make sure that inlets are unobstructed, that the protective caps are in place, that the connections are conspicuously marked and accessible for the fire department, and that hose threads are in good condition.
- Annually, lubricate each valve stem and reseal to prevent leaks.
- Annually, close and reopen each post indicator and outside stem and yoke (OS&Y) valve.
- Annually, inspect fire department connections before freezing weather. The connection should be drained through the ball drip from the check valve to ensure it will not freeze.
- Every 5 years, replace the gaskets in check valves.
- Every 5 years, recalibrate and/or replace pressure gauges, if necessary.
- Fifty years after installation, remove a representative sample of sprinklers (at least two per floor) and have them operationally tested at a testing laboratory. Based on tests, replace sprinklers if necessary. Test a sampling of the sprinklers every 10 years thereafter.
- Fifty years after installation, inspect the sprinkler system in at least five remote and low-point locations to determine the degree of pipe corrosion. Where corrosion is found, have a fire protection engineer or sprinkler designer determine the hydraulic performance of the sprinkler system.

### Wet Pipe and Antifreeze Systems

- Annually, open the inspector's test connection and test all alarms (water motor alarm and/or flow/pressure switch).
- Annually, before freezing weather, test the freezing point of antifreeze solutions with a hydrometer. Maintain the solution below the estimated minimum temperature.
- Annually, make sure wet pipe systems are properly protected from freezing.

### Dry, Deluge, and Preaction Systems

- Annually, before freezing weather, operate the heating system in enclosures housing valves to ensure temperature can be maintained above 5.5°C (42°F).
- Annually, before freezing weather, open all low-point drains to remove condensation and clean plugged or obstructed sprinklers.
- Annually, remove face plates of dry, deluge, and preaction valves and examine interior for corrosion and condition of gasket.
- Annually, trip test the dry pipe, deluge, or preaction valve. Ensure quick opening devices operate properly. Once the main valve trips, quickly close the control valve.
- Every 3 years, flush system with water. The system should be filled with water for 2 days before flushing to allow pipe scale and deposits to soften. Drain system and then flush. Flush cross mains first by attaching 50 mm (2 in.) fire hose at the end of the cross main. Flow water until clear. Also, record the residual water pressure from the supply-side water pressure gauge. Remove and reinstall all pendent sprinklers after flushing is complete.
- Annually, activate preaction and deluge systems by operating the fire detection devices. Close the control valve to prohibit water from entering the system.
- Annually, lubricate air compressors on preaction and dry systems in accordance with manufacturer recommendations.
- Annually, test low air pressure alarm on preaction and dry systems. Close the water supply valve. Slowly release air from the system by slowly opening the inspector's test valve. Release enough pressure to sound the alarm. Avoid tripping the dry pipe valve.
- Quarterly, determine dry pipe system priming water level by slowly opening the priming water level. If only air escapes, close the test valve and add about one quart of water. Repeat the procedure until water comes out of the test valve.
- Annually, flow test open sprinklers on deluge sprinkler systems during warm weather.

**N K.2 Maintenance of Fire Detection and Alarm Systems.** Fire detection and alarm systems should be tested at regular intervals. Test methods and frequency of tests should be in accordance with *NFPA 72*. Some of the tests that should be performed are as follows.

**Alarms**

- Annually, test audible devices, visible devices, and emergency voice/alarm communication equipment.

**Control and Annunciation Units**

- Quarterly, for unmonitored systems, and annually, for monitored systems, test all functions, interfaced equipment, main and standby power supply, and fuses.

**Batteries**

- Annually, test the charger. Conduct a 30-minute discharge test semiannually, for lead acid batteries, and annually, for nickel-cadmium batteries.

**Alarm Initiation Devices**

- Annually, test all smoke detectors, fire alarm boxes, and restorable heat detectors. Smoke detector sensitivity should be checked as detailed in *NFPA 72*.
- Other tests, depending on the type of fire alarm system installed, should be conducted as detailed in *NFPA 72*.

**N K.3 Maintenance of Fire Hose Stations.** Where fire hose is allowed, hose stations should have monthly and annual (all-weather) maintenance tags attached for recording the inspector's initials, date, and confirmation on maintenance/inspections performed on the system. Checklists detailing maintenance should be kept by the office responsible for maintenance. All problems noted should be corrected before initialing the maintenance tag.

- Inspect fire hose stations monthly. Hose stations need to contain a minimum of 45 m (150 ft) of hose, a hose nozzle, and a hydrant wrench. Hose should not be damaged or show mildew. Hose needs to be neatly rolled or racked.
- Test nozzles monthly to confirm that they can be easily opened and closed.
- Rerack or rewind hose annually.

**N K.4 Maintenance of Fire Hydrants.** Fire hydrants should have annual maintenance tags attached for recording the inspector's initials, date, and confirmation on maintenance/inspections performed on the system. Checklists detailing maintenance should be kept by the office responsible for maintenance. All problems noted should be corrected before initialing the maintenance tag.

- Annually, inspect fire hydrants in the fall to ensure the following:
  - (1) Tightness of hydrant outlet
  - (2) No leaks in top of hydrant
  - (3) No cracks in hydrant barrel
  - (4) Hydrant drain is clear
  - (5) Turning nut is not worn down with rounded corners
  - (6) Undamaged nozzle threads
- Annually, lubricate operating nut, parking, and trust collars.

(continues)

- Annually, perform a flow test to check for proper hydrant operation and to test the available water supply in accordance with *NFPA 291*. Flow water from each hydrant.

**N K.5 Maintenance of Fire Pumps.** Fire pumps should have weekly and annual maintenance tags attached for recording the inspector's initials, date, and confirmation on maintenance/inspections performed on the system. Water flow meters should have 5-year maintenance tags attached. Checklists detailing maintenance should be kept by the museum. All problems noted should be corrected before initialing the maintenance tag.

**Weekly**

- Close system valve to avoid pressurizing the automatic sprinkler system. Turn jockey pump off and gradually release pressure in the sprinkler system to confirm that low system pressure turns fire pump on. Run pump for 10 minutes. Check for excessive heat or water leakage at packing glands. At the end of the test, confirm that the fire pump and jockey pump controllers are on automatic and that the pump supply and discharge valves and the sprinkler system valves are open.
- Record suction and discharge pressure on the maintenance tag.

**Annually**

- Perform annual flow test in accordance with *NFPA 20*.
- Turn jockey pump off and gradually release pressure in the sprinkler system to confirm that low system pressure turns fire pump on.
- Confirm proper operation of remote annunciation for pump on and power supervision on fire alarm control unit.
- Close and open control valves to ensure proper operation. Also, confirm that tamper switches on control valves are operational.
- Lubricate motors and engines in accordance with manufacturer recommendations.

**Every 5 Years**

- Calibrate the water flow meter, if one is installed, during the annual flow test.

**N K.6 Maintenance of Water Storage Tanks Used for Fire Protection.** Water storage tanks used for fire protection should have monthly, annual, and 5-year maintenance tags attached at the main control valve for recording the inspector's initials, date, and confirmation on maintenance/inspections performed on the system. Checklists detailing maintenance should be kept by the office responsible for maintenance. All problems noted should be corrected before initialing maintenance tag.

- Check water level in storage tanks monthly.
- Operate control valves monthly to ensure that they are properly arranged (generally open) and operational.
- Inspect storage tanks annually for the following:

(continues)

- (1) General condition of the tank, including loose scale, leaky seams or rivets, and paint
- (2) Ladders on tanks for structural adequacy and the presence of rust
- (3) The roof of storage tanks for structural stability and the presence of rust
- (4) Sway bracing for elevated water storage tanks for structural adequacy and the presence of rust
- Conduct a flow test annually to make sure that equipment is performing properly, pipes are unobstructed, and appropriate valves are open. Perform in conjunction with fire hydrant annual tests (see Section K.4).
- Approximately every 5 years, thoroughly clean the interior and exterior of the tank and repaint. Temporary water supplies for fire protection need to be provided before the tank is drained.

**N K.7 Maintenance of Halon Systems.** Halon systems should have monthly, annual, and 5-year maintenance tags attached to the halon cylinders for recording the inspector's initials, date, and confirmation on maintenance/inspections performed on the system. Checklists detailing maintenance should be kept by the office responsible for maintenance. All problems found should be corrected before initialing the maintenance tag. (Fire alarm functions should be maintained in accordance with Section K.1.)

#### Monthly

- Inspect the halon cylinders and piping for physical damage.
- Record the new pressure reading on the maintenance tag. Pressure must be within 10 percent of previous reading on the maintenance tag. Low readings require weighing the tank to confirm low pressure. Report confirmed low readings. Do not refill system.

#### Annually

- Weigh cylinders, and determine if weight is within 5 percent of previous reading on the maintenance tag. Record pressure on maintenance tag. Report low readings. Do not refill system.
- Operate control valves and correct any problems found.
- Perform an operational test on the system without discharging halon. (Remove the control heads from the halon cylinders and operate the fire detectors.) Correct any problems found.

#### Every 5 Years

- Replace rubber hoses.
- Perform a fan pressurization test in the room.

**N K.8 Maintenance of Emergency Generator and Emergency Lighting.** Emergency generators should have weekly and annual maintenance tags attached for recording the inspector's initials, date, and confirmation of maintenance/inspections performed on the systems. Checklists detailing maintenance should be kept by the office responsible for maintenance.

- Operate emergency generators weekly. Correct potential operational problems.
- Operate emergency generator under a simulated load biannually.
- Lubricate motors and engines annually in accordance with manufacturer recommendations.
- Perform an emergency lighting test biannually using the emergency generator. Fire pump(s), fire alarm systems, and electronic exit locking systems should be tested on emergency power concurrently.

**N K.9 Maintenance of Waterspray Systems for Kitchens.** Annually, inspect contracts to confirm waterspray systems are being maintained in accordance with manufacturer recommendations, including the following:

- (1) The monthly inspection of systems is done by a company specializing in the maintenance of these systems.
- (2) Sprinklers are clean of grease.
- (3) Gas and electric power shutoff are tested.
- (4) Water-wash hood cleaning systems are operational.
- (5) Sprinklers need to be replaced in accordance with manufacturer recommendations.
- (6) Manual pull stations send a signal to the control room.
- (7) Sprinklers are of the correct temperature rating and located directly above grease-producing equipment at the correct height.
- (8) Monthly and annual maintenance tags are attached for recording the inspector's initials, date, and confirmation on maintenance/inspections performed on the system. Checklists detailing maintenance should be kept by the responsible office.

**N K.10 Maintenance of Dry Chemical Systems.** Annually, inspect contracts to ensure dry chemical systems are being maintained in accordance with manufacturer recommendations, including the following:

- (1) The monthly inspection of a system is done by a company specializing in the maintenance of these systems.
- (2) Nozzles are clean of grease.
- (3) Gas and electric power shutoff are tested.
- (4) Water-wash hood cleaning systems are operational.
- (5) Fusible links are replaced annually.
- (6) Manual pull stations send a signal to the control room.
- (7) Fusible links are of the correct temperature rating.
- (8) Nozzles are located directly above grease-producing equipment at the correct height.
- (9) Pressure on gauge is adequate.
- (10) Manual release stations are operational and accessible.
- (11) Monthly and annual maintenance tags are attached for recording the inspector's initials, date, and confirmation on maintenance/inspections performed on the system. Checklists detailing maintenance should be kept by the responsible office.

**N K.11 Maintenance of Fire Doors and Fire Dampers.** Personnel responsible for maintenance should have location maps of fire doors and fire dampers and checklists detailing maintenance on each door or damper.

**Fire Doors**

- Annually, inspect fire doors for the following items. Correct any problems found.
  - (1) Door envelope does not have punctures or broken seams.
  - (2) Self-closer is intact and allows door to latch closed.
  - (3) Sliding door, chains, and cables should operate smoothly over all pulleys and guides.
  - (4) Doors have not been modified in the field (e.g., by the installation of louvers).
  - (5) Coordinators are securely attached and adjusted properly.
  - (6) Clearances around the door do not exceed the following:
    - (a) Between door and frame — 3.2 mm ( $\frac{1}{8}$  in.)
    - (b) Between meeting edges of doors — 3.2 mm ( $\frac{1}{8}$  in.)
    - (c) Between bottom of door and raised sill — 9.5 mm ( $\frac{3}{8}$  in.)
    - (d) Between bottom of door and floor (no sill) — 19.0 mm ( $\frac{3}{4}$  in.)
- Annually, test doors normally held open by automatic closing devices to confirm proper operation. Sliding doors need to be allowed to close completely to check the operation of the guides and rollers. Correct any problems found.
- Annually, lubricate guides and bearings.

**Fire Dampers**

- Annually, test fire dampers to ensure that hinges and other moving parts operate properly. Remove fusible links; operate damper; and check latch (if provided). It is desirable to operate dampers with normal system air flow to ensure that they are not held open by the air stream. Correct any problems found.
- Annually, lubricate moving parts of the damper.

Note that smoke dampers should be tested with the operation of fire detectors in accordance with Section K.2.

**N K.12 Maintenance of Stair Pressurization and Smoke Venting Systems.** Fans used for stairwell pressurization and smoke venting should have annual maintenance tags attached for recording the inspector's initials, date, and confirmation on maintenance/inspections performed on the system. Checklists detailing maintenance should be kept by the office responsible for maintenance.

- Annually, perform an air pressure test in stairwells having pressurization fans to make sure all system parts and controls are operational and design air pressures (not to exceed NFPA 101 requirements) are obtained. Correct any problems found before initialing the maintenance tag.

(continues)

- Annually, lubricate fan motors in accordance with manufacturer recommendations.

**N K.13 Maintenance of Portable Fire Extinguishers.**

- Each extinguisher needs to have an inspection tag.
- Monthly, inspect extinguishers. An extinguisher inspection includes ensuring that extinguishers are fully charged, in their designated locations, physically undamaged, not tampered with, and not obstructed, and that the hydrostatic test is up to date. The inspector should initial the inspection tag after the extinguisher is found in good working order and should perform the following as needed:
  - (1) Report obstructed or out-of-place extinguishers to the building manager.
  - (2) Replace any extinguisher that is physically damaged or that has a broken or missing tamper indicator (plastic seal around the handle).
  - (3) Replace any extinguisher on which the gauge indicates "recharge" or, in the case of carbon dioxide extinguishers, when there is a weight loss of 10 percent or more (the weight is listed on the label of the extinguisher). For example, if the label indicates 15.2 kg (33  $\frac{1}{2}$  lb), replace the extinguisher when the weight goes below 14.0 kg (31 lb). The weight should be checked semiannually.
  - (4) Replace any extinguisher requiring a hydrostatic test in accordance with the following dates given. Each extinguisher is marked with the date of the last hydrostatic test (e.g., 1/26/80 or 1@80). Look for the most recent date, and calculate when the extinguisher needs to be tested again. For example, a carbon dioxide extinguisher date 1@80 should be retested in January 1985. (When an extinguisher needs to be replaced, use a spare extinguisher of the same type and at least equal rating as the one being replaced.)

**Extinguisher Types**

Dry chemical	12 years
Carbon dioxide	5 years
Stored water pressure	5 years
Halon	12 years

**Hydrostatic Test Period**

**N K.14 Maintenance of Lightning Protection Systems.** Those responsible for maintenance/inspection should have detailed drawings of lightning protection systems and checklists detailing maintenance.

- Annually, inspect system for mechanical damage.
- Annually, test all connections for electrical resistance. If resistance to ground is more than 5 ohms, make necessary changes to reduce it to 5 ohms or less.

## Annex L Sensitivity and Uncertainty Analysis and Safety Factors

*This annex is not a part of the requirements of this NFPA document but is included for informational purposes only.*

**L.1 General.** The assessment of precision required in 9.8.2 requires sensitivity and uncertainty analysis, which can be translated into safety factors. Additional information on conducting an uncertainty analysis can be found in the *SFPE Handbook of Fire Protection Engineering*.

**L.2 Sensitivity Analysis.** The first run a model user makes should be labeled as the base case, using the nominal values of the various input parameters. However, the model user should not rely on a single run to use as the basis for any performance-based fire safety system design. Ideally, each variable or parameter that the model user made to develop the nominal input data should have multiple runs associated with it, as should combinations of key variables and parameters. Thus, a sensitivity analysis should be conducted that provides the model user with data that indicate how the effects of a real fire can vary and how the response of the proposed fire safety design can also vary.

The interpretation of a model's predictions can be a difficult exercise if the model user does not have knowledge of fire dynamics or human behavior.

**L.3 Reasonableness Check.** The first thing the model user should try to determine is whether the predictions actually make sense (i.e., do not upset intuition or preconceived expectations). Most likely, if the results do not pass this test, an input error has been committed.

Sometimes the predictions appear to be reasonable but are, in fact, incorrect. For example, a model can predict higher temperatures farther from the fire than close to it. The values themselves can be reasonable (e.g., not hotter than the fire), but they do not "flow" down the energy as expected.

A margin of safety can be developed using the results of the sensitivity analysis, which provides the possible range of when a condition is estimated to occur, in conjunction with the performance criteria.

Safety factors and margin of safety are two concepts used to quantify the amount of uncertainty in engineering analyses. Safety factors are used to provide a margin of safety and to represent or address the gap in knowledge between the theoretically perfect model (i.e., reality) and the engineering models that can represent reality only partially.

Safety factors can be applied to either the predicted level of a physical condition or the time that the condition is predicted to occur. Thus, a physical or a temporal safety factor can be applied to any predicted condition. A predicted condition (i.e., a parameter's value) and the time it occurs are best represented as distributions. Ideally, a computer fire model predicts the expected or nominal value of the distribution. Safety factors are intended to represent the spread of these distributions.

Given the uncertainty associated with data acquisition and reduction and the limitations of computer modeling, any condition predicted by a computer model can be thought of as an expected or nominal value within a broader range. For example, an upper-layer temperature of 600°C is predicted at a given time. If the modeled scenario is then tested (i.e., in a full-

scale experiment based on the computer model's input data), the actual temperature at that given time could be 640°C or 686°C. Therefore, the temperature should be reported as 600°C (+40,-16) or as a range of 686°C to 640°C.

Ideally, a prediction is reported as a nominal value, with some percentage, or as an absolute value. For example, an upper-layer temperature prediction could be reported as "600°C, 30°C" or "600°C, 6%." In this case, the physical safety factor is 0.06 (i.e., the amount by which the nominal value should be degraded and enhanced). Given the state of the art of computer fire modeling, this is a very low safety factor. Physical safety factors tend to be on the order of tens of percent; 60 percent is not unheard of.

Part of the problem with this approach is that it is difficult to state what percentage or range is appropriate. These values can be obtained when the computer model predictions are compared to test data. However, using computer fire models in a design model does not facilitate determination of the range of values since (1) the room being analyzed has not been built yet, and (2) test scenarios do not necessarily depict the intended design.

A sensitivity analysis should be performed on the assumptions that affect the condition of interest, and a base case developed that uses all nominal values for input parameters. The input parameters should be varied over reasonable ranges, and the variation in predicted output noted. This output variation can then become the basis for physical safety factors.

The temporal safety factor addresses the issue of when a condition is predicted and is a function of the rate at which processes are expected to occur. If a condition is predicted to occur 2 minutes after the start of the fire, then that time frame can be used as a nominal value. A process similar to that described above for physical safety factors can also be employed to develop temporal safety factors. In this case, however, the rates (e.g., of heat release or toxic product generation) will be varied instead of absolute values (e.g., material properties).

The margin of safety can be thought of as a reflection of societal values and can be imposed by the authority having jurisdiction to that purpose. Since the predicted time for a condition will most likely be the focus of authorities having jurisdiction (e.g., the model predicts occupants will have 5 minutes to safely evacuate), the margin of safety will be characterized here by temporal aspects and tacitly applied to the physical margin of safety.

Since escaping (or mitigating) the harmful effects of fire is, effectively, a race, time is the metric of choice in the assessment of fire safety system designs based on computer model predictions. When an authority having jurisdiction is faced with the predicted time of untenability, a decision needs to be made regarding whether sufficient time is available to ensure the safety of building occupants. The authority having jurisdiction, in assessing the margin of safety, needs to determine whether there is sufficient time to get everyone out safely. If the authority having jurisdiction feels that the predicted egress time is too close to the time of untenability, the authority having jurisdiction can impose an additional time that the designer needs to incorporate into the system design. In this way, the authority having jurisdiction can impose a greater margin of safety than that originally proposed by the designer.

### Annex M Sample Ordinance Adopting NFPA 914

*This annex is not a part of the requirements of this NFPA document but is included for informational purposes only.*

**M.1** The following sample ordinance is provided to assist a jurisdiction in the adoption of this [code, standard] and is not part of this [code, standard].

ORDINANCE NO. \_\_\_\_\_

An ordinance of the [jurisdiction] adopting the [year] edition of NFPA [document number], [complete document title], and documents listed in Chapter 2 of that [code, standard]; prescribing regulations governing conditions hazardous to life and property from fire or explosion; providing for the issuance of permits and collection of fees; repealing Ordinance No. \_\_\_\_\_ of the [jurisdiction] and all other ordinances and parts of ordinances in conflict therewith; providing a penalty; providing a severability clause; and providing for publication; and providing an effective date.

BE IT ORDAINED BY THE [governing body] OF THE [jurisdiction]:

**SECTION 1** That the [complete document title] and documents adopted by Chapter 2, three (3) copies of which are on file and are open to inspection by the public in the office of the [jurisdiction's keeper of records] of the [jurisdiction], are hereby adopted and incorporated into this ordinance as fully as if set out at length herein, and from the date on which this ordinance shall take effect, the provisions thereof shall be controlling within the limits of the [jurisdiction]. The same are hereby adopted as the [code, standard] of the [jurisdiction] for the purpose of prescribing regulations governing conditions hazardous to life and property from fire or explosion and providing for issuance of permits and collection of fees.

**SECTION 2** Any person who shall violate any provision of this code or standard hereby adopted or fail to comply thereunder; or who shall violate or fail to comply with any order made thereunder; or who shall build in violation of any detailed statement of specifications or plans submitted and approved thereunder; or fail to operate in accordance with any certificate or permit issued thereunder; and from which no appeal has been taken; or who shall fail to comply with such an order as affirmed or modified by a court of competent jurisdiction, within the time fixed herein, shall severally for each and every such violation and noncompliance, respectively, be guilty of a misdemeanor, punishable by a fine of not less than \$ \_\_\_\_\_ nor more than \$ \_\_\_\_\_ or by imprisonment for not less than \_\_\_\_\_ days nor more than \_\_\_\_\_ days or by both such fine and imprisonment. The imposition of one penalty for any violation shall not excuse the violation or permit it to continue; and all such persons shall be required to correct or remedy such violations or defects within a reasonable time; and when not otherwise specified the application of the above penalty shall not be held to prevent the enforced removal of prohibited conditions.

Each day that prohibited conditions are maintained shall constitute a separate offense.

**SECTION 3** Additions, insertions, and changes — that the [year] edition of NFPA [document number], [complete document title] is amended and changed in the following respects:

#### List Amendments

**SECTION 4** That ordinance No. \_\_\_\_\_ of [jurisdiction] entitled [fill in the title of the ordinance or ordinances in effect at the present time] and all other ordinances or parts of ordinances in conflict herewith are hereby repealed.

**SECTION 5** That if any section, subsection, sentence, clause, or phrase of this ordinance is, for any reason, held to be invalid or unconstitutional, such decision shall not affect the validity or constitutionality of the remaining portions of this ordinance. The [governing body] hereby declares that it would have passed this ordinance, and each section, subsection, clause, or phrase hereof, irrespective of the fact that any one or more sections, subsections, sentences, clauses, and phrases be declared unconstitutional.

**SECTION 6** That the [jurisdiction's keeper of records] is hereby ordered and directed to cause this ordinance to be published.

[NOTE: An additional provision may be required to direct the number of times the ordinance is to be published and to specify that it is to be in a newspaper in general circulation. Posting may also be required.]

**SECTION 7** That this ordinance and the rules, regulations, provisions, requirements, orders, and matters established and adopted hereby shall take effect and be in full force and effect [time period] from and after the date of its final passage and adoption.

### Annex N Secretary of the Interior's Standards

*This annex is not a part of the requirements of this NFPA document but is included for informational purposes only.*

**N.1** In the United States, the Interior Secretary provides guidelines for rehabilitation and operation of historic sites. The guidelines can be found at <https://www.nps.gov/tps/standards/rehabilitation/rehabilitation-guidelines.pdf>.

### Annex O Guideline on Fire Ratings of Archaic Materials and Assemblies

*This annex is not a part of the requirements of this NFPA document but is included for informational purposes only.*

**O.1** The *Guidelines on Fire Ratings of Archaic Materials and Assemblies* can be found at <https://www.huduser.gov/portal/Publications/PDF/fire.pdf>.

### Annex P BSI Timber Panel Door Standard

*This annex is not a part of the requirements of this NFPA document but is included for informational purposes only.*

**P.1 Ability to Withstand Fire Exposure.** The information provided in this annex shows a summary of the ability of various door configurations to withstand a fire exposure on one side. This information might be useful to assist in establishing equivalent door designs in existing buildings when it may be impractical to install modern fire doors. This annex is extracted from the U.S. Department of Housing and Urban Development, *Guideline on Fire Ratings of Archaic Materials and Assemblies*.

**P.2 Upgrading the Fire Resistance of Wood Panel Doors.** This section contains information from the English Heritage Technical Guidance Note, "Timber Paneled Doors and Fire," on upgrading the fire resistance of wood panel doors. Twenty-eight panel door treatments are shown in Figure P.2, and the fire resistance ("result") of each is stated in minutes.

The fire resistance data is based on tests performed in accordance with British Standard 476, *Fire Tests on Building Materials and Structures*. The actual fire resistance of each door treatment will vary with the door's condition, the quality of its construction, and the hardware used.

Test reference notations are composed of the initials of the test sponsor, the initials of the testing house, the test number, and the test date, such as EH/WFRC 55983 7/4/92, where:

EH	=	English Heritage
GLC	=	Greater London Council
HRPA	=	Historic Royal Palaces Agency
FRS	=	Fire Research Station
FITO	=	Fire Insurers Test Organization
TRADA	=	Timber Research and Development Association
WFRC	=	Warrington Fire Research Center

Dimensions are shown in millimeters, where:

$\frac{1}{8}$ in.	=	3.2 mm
$\frac{1}{4}$ in.	=	6.4 mm
$\frac{3}{8}$ in.	=	9.5 mm
$\frac{1}{2}$ in.	=	12.7 mm
$\frac{5}{8}$ in.	=	15.9 mm
$\frac{3}{4}$ in.	=	19.0 mm
$\frac{7}{8}$ in.	=	22.2 mm
1 in.	=	25.4 mm

Since 0.1 mm equals only  $\frac{1}{254}$  in., conversions may be rounded to the nearest millimeter ( $\frac{1}{25.4}$  in.).

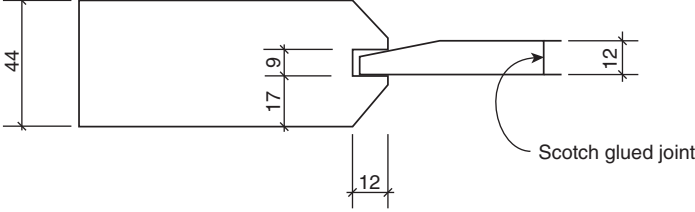
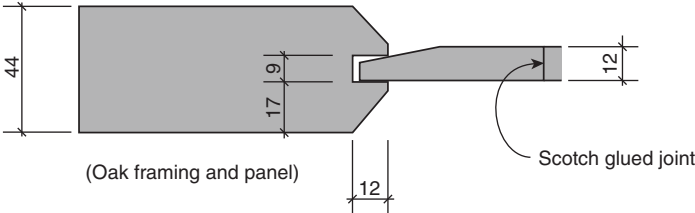
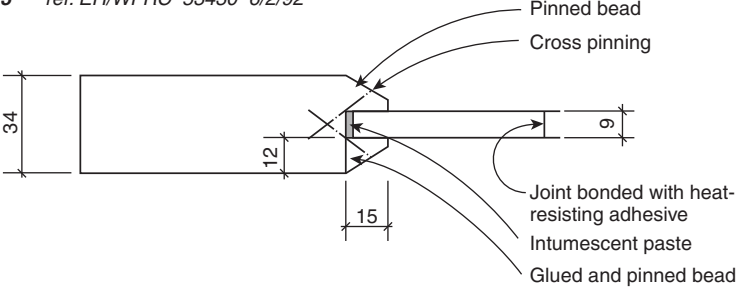
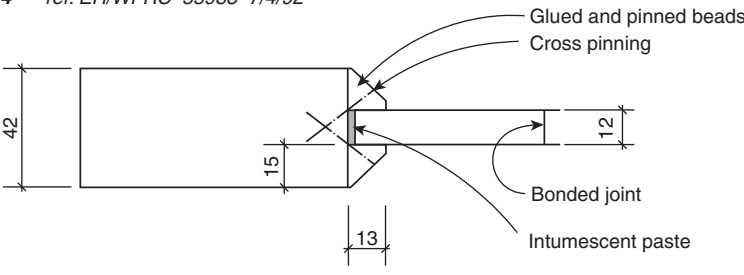
<i>face exposed to fire</i>	<b>Result</b> (minutes)
<p><b>1</b> ref: GLC/FRS 30/6/80</p> 	<p><b>11</b> Location of failure: panel joint</p>
<p><b>2</b> ref: GLC/FRS 30/6/80</p>  <p>(Oak framing and panel)</p>	<p><b>9</b> Location of failure: panel joint</p>
<p><b>3</b> ref: EH/WFRC 53430 6/2/92</p> 	<p><b>15</b> Location of failure: burn through panel</p>
<p><b>4</b> ref: EH/WFRC 55983 7/4/92</p> 	<p><b>20</b> Location of failure: panel/framing joint</p>

Note: All doors constructed from softwood unless otherwise stated.

(1 of 7)

**△ FIGURE P.2 Summary of Fire Test Results. (Source: National Institute of Building Sciences; reprinted by permission of English Heritage.)**

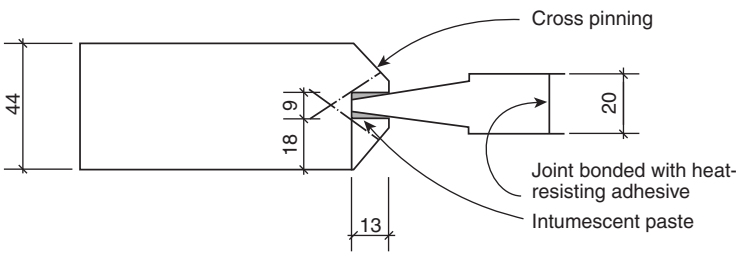
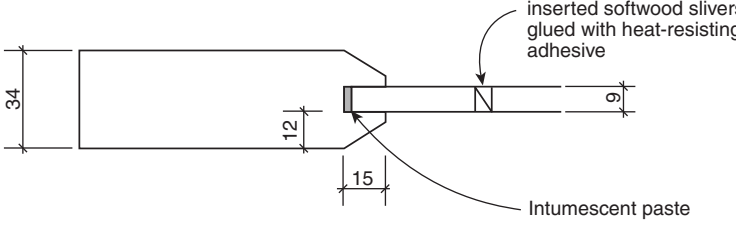
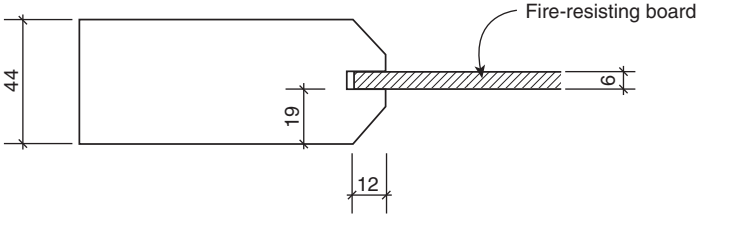
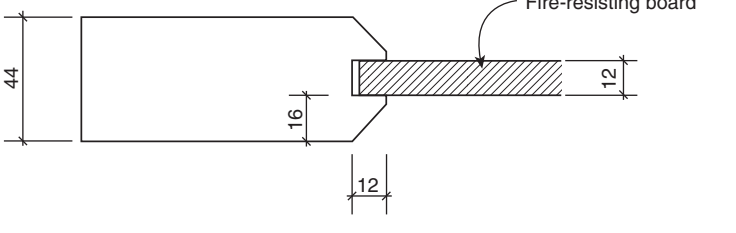

	<b>Result</b> (minutes)
<p><b>5</b> ref: EH/WFRC 48927 6/6/90</p>  <p>Cross pinning</p> <p>Joint bonded with heat-resisting adhesive</p> <p>Intumescent paste</p>	<p><b>24</b></p> <p>Location of failure: panel/framing joint</p>
<p><b>6</b> ref: EH/WFRC 53430 6/2/90</p>  <p>Joint bonded with inserted softwood slivers glued with heat-resisting adhesive</p> <p>Intumescent paste</p>	<p><b>6</b></p> <p>Location of failure: panel joint</p>
<p><b>7</b> ref: GLC/FRS 2/7/80</p>  <p>Fire-resisting board</p>	<p><b>16.5</b></p> <p>Location of failure: panel/framing joint</p>
<p><b>8</b> ref: GLC/FRS 2/7/80</p>  <p>Fire-resisting board</p>	<p><b>13</b></p> <p>Location of failure: panel/framing joint</p>

Note: All doors constructed from softwood unless otherwise stated.

(2 of 7)

▲ FIGURE P.2 Continued

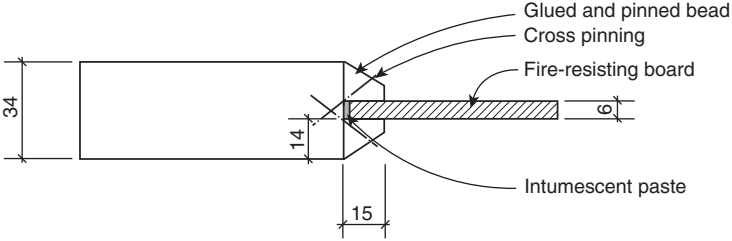
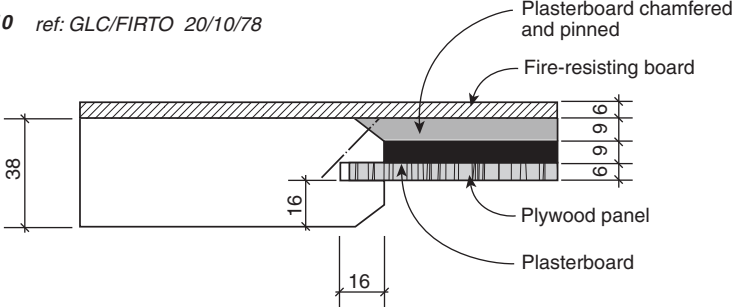
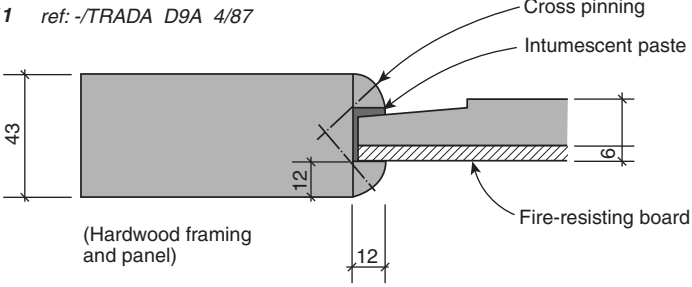
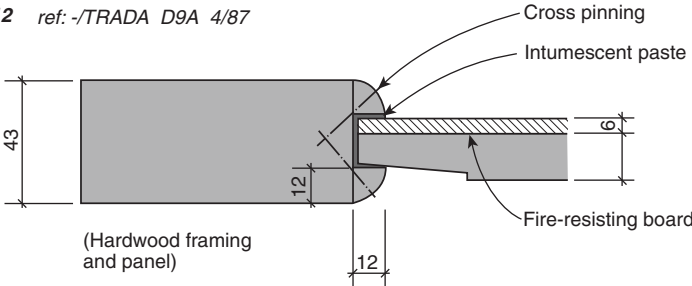
	<b>Result</b> (minutes)
<p><b>9</b> ref: EH/WFRC 53462 6/4/92</p>  <p>Glued and pinned bead Cross pinning Fire-resisting board Intumescent paste</p>	<b>29</b>
<p><b>10</b> ref: GLC/FIRTO 20/10/78</p>  <p>Plasterboard chamfered and pinned Fire-resisting board Plywood panel Plasterboard</p>	<b>28</b> Location of failure: door leaf/frame junction
<p><b>11</b> ref: -TRADA D9A 4/87</p>  <p>Cross pinning Intumescent paste Fire-resisting board</p> <p>(Hardwood framing and panel)</p>	<b>30</b>
<p><b>12</b> ref: -TRADA D9A 4/87</p>  <p>Cross pinning Intumescent paste Fire-resisting board</p> <p>(Hardwood framing and panel)</p>	<b>21</b>

Note: All doors constructed from softwood unless otherwise stated.

(3 of 7)

▲ FIGURE P.2 Continued

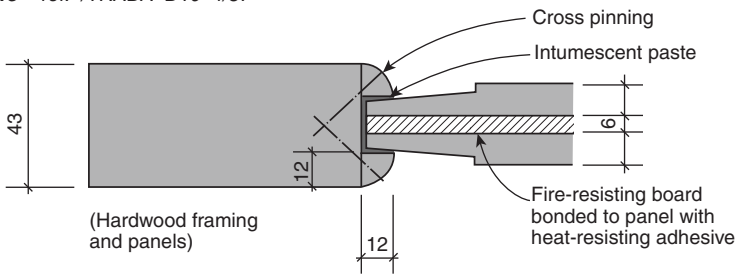
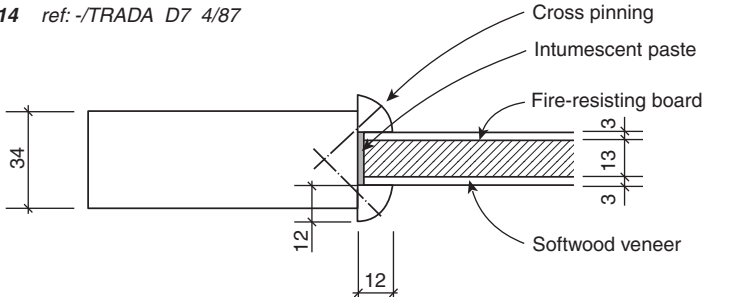
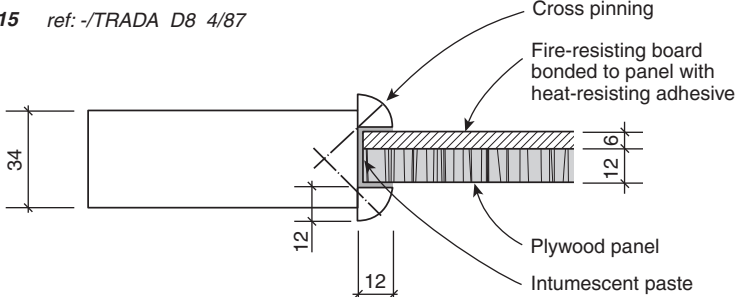
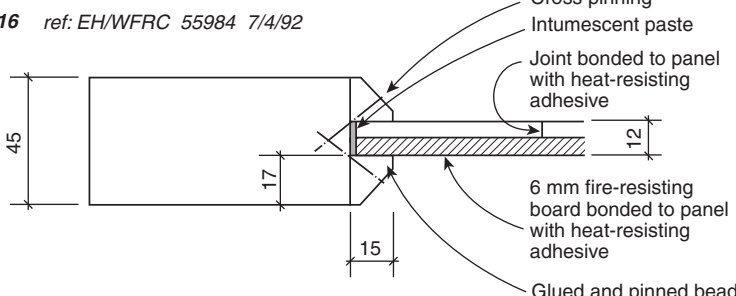
	<b>Result (minutes)</b>
<p><b>13</b> ref: -/TRADA D10 4/87</p>  <p>(Hardwood framing and panels)</p> <p>Cross pinning</p> <p>Intumescent paste</p> <p>Fire-resisting board bonded to panel with heat-resisting adhesive</p>	<b>30</b>
<p><b>14</b> ref: -/TRADA D7 4/87</p>  <p>Cross pinning</p> <p>Intumescent paste</p> <p>Fire-resisting board</p> <p>Softwood veneer</p>	<b>30</b>
<p><b>15</b> ref: -/TRADA D8 4/87</p>  <p>Cross pinning</p> <p>Fire-resisting board bonded to panel with heat-resisting adhesive</p> <p>Plywood panel</p> <p>Intumescent paste</p>	<b>30</b>
<p><b>16</b> ref: EH/WFRC 55984 7/4/92</p>  <p>Cross pinning</p> <p>Intumescent paste</p> <p>Joint bonded to panel with heat-resisting adhesive</p> <p>6 mm fire-resisting board bonded to panel with heat-resisting adhesive</p> <p>Glued and pinned beads</p>	<b>30+</b>

Note: All doors constructed from softwood unless otherwise stated.

(4 of 7)

△ FIGURE P.2 Continued

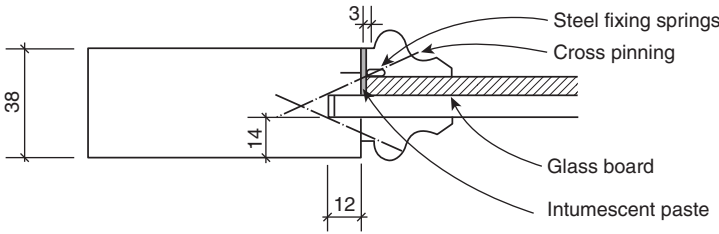
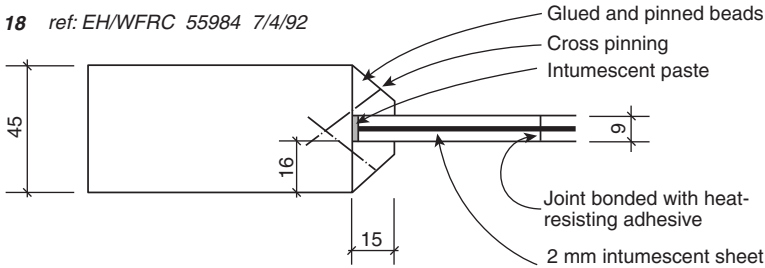
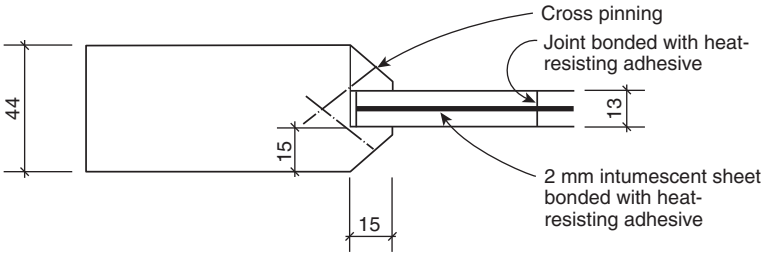
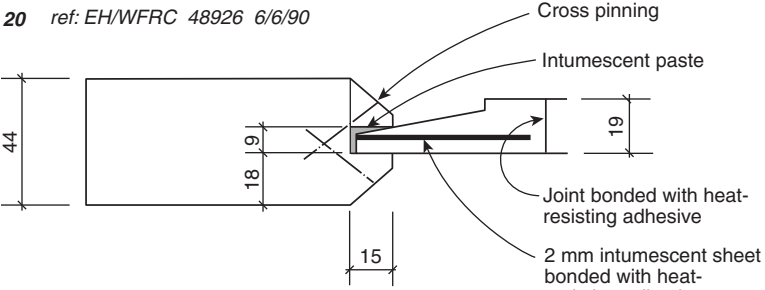
	<b>Result</b> (minutes)
<p><b>17</b> ref: EH/WFRC 60184 25/10/93</p>  <p>Steel fixing springs Cross pinning Glass board Intumescent paste</p>	<p><b>27</b> Location of failure: panel/framing joint</p>
<p><b>18</b> ref: EH/WFRC 55984 7/4/92</p>  <p>Glued and pinned beads Cross pinning Intumescent paste Joint bonded with heat-resisting adhesive 2 mm intumescent sheet bonded with heat-resisting adhesive</p>	<p><b>23</b> Location of failure: burn through panel</p>
<p><b>19</b> ref: EH/WFRC 48926 6/6/90</p>  <p>Cross pinning Joint bonded with heat-resisting adhesive 2 mm intumescent sheet bonded with heat-resisting adhesive</p>	<p><b>30+</b></p>
<p><b>20</b> ref: EH/WFRC 48926 6/6/90</p>  <p>Cross pinning Intumescent paste Joint bonded with heat-resisting adhesive 2 mm intumescent sheet bonded with heat-resisting adhesive</p>	<p><b>30+</b></p>

Note: All doors constructed from softwood unless otherwise stated.

(5 of 7)

△ FIGURE P.2 Continued

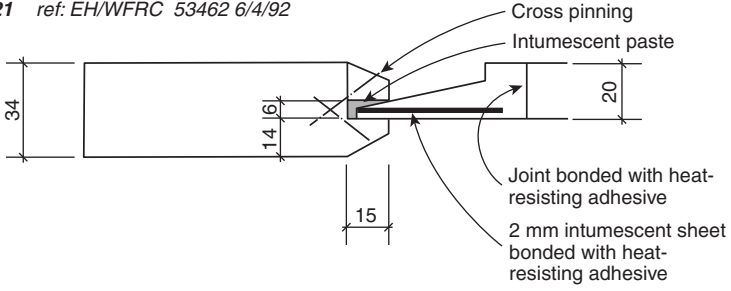
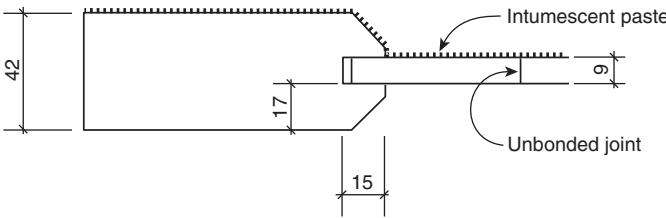
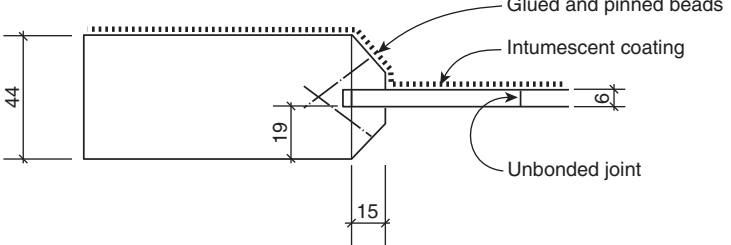
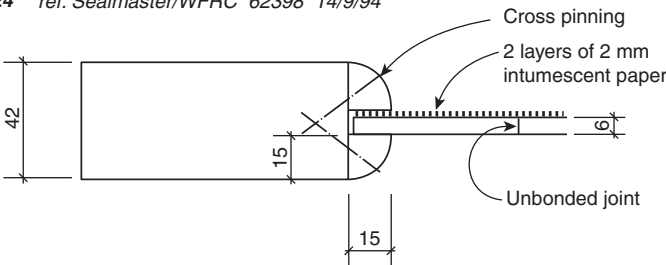
<p style="text-align: center;"><i>face exposed to fire</i></p>	<p style="text-align: center;"><b>Result</b> (minutes)</p>
<p><b>21</b> ref: EH/WFRC 53462 6/4/92</p>  <p>Cross pinning Intumescent paste Joint bonded with heat-resisting adhesive 2 mm intumescent sheet bonded with heat-resisting adhesive</p> <p>34 14   6   15 20</p>	<p style="text-align: center;"><b>29.5</b> Location of failure: burn through panel</p>
<p><b>22</b> ref: EH/WFRC 55983 7/4/92</p>  <p>Intumescent paste Unbonded joint</p> <p>42 17 15 9</p>	<p style="text-align: center;"><b>11</b> Location of failure: panel joint</p>
<p><b>23</b> ref: EH/WFRC 48927 6/6/90</p>  <p>Glued and pinned beads Intumescent coating Unbonded joint</p> <p>44 19 15 6</p>	<p style="text-align: center;"><b>17</b> Location of failure: panel/frame joint</p>
<p><b>24</b> ref: Sealmaster/WFRC 62398 14/9/94</p>  <p>Cross pinning 2 layers of 2 mm intumescent paper Unbonded joint</p> <p>42 15 15 6</p>	<p style="text-align: center;"><b>30+</b></p>

Note: All doors constructed from softwood unless otherwise stated.

(6 of 7)

▲ FIGURE P.2 Continued

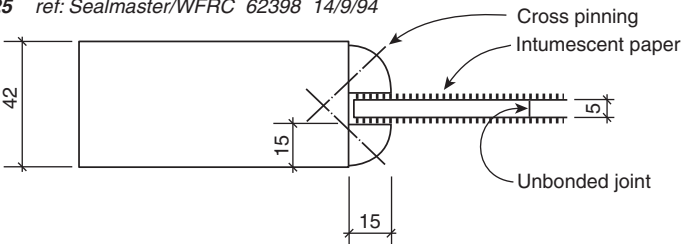
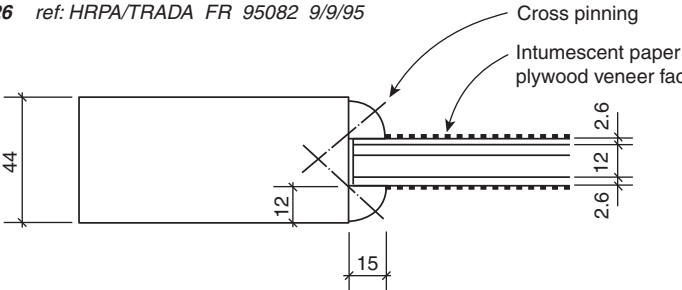
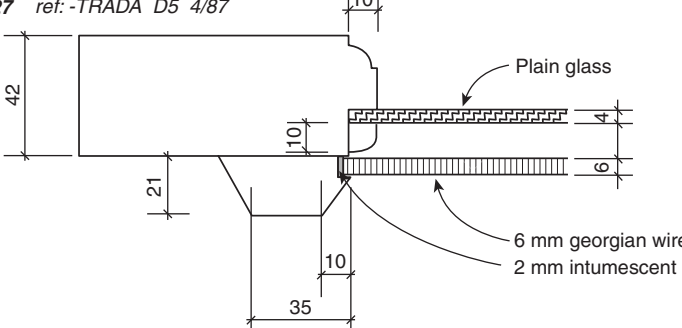
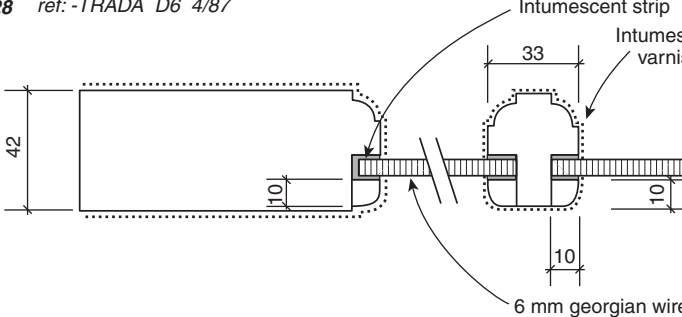
	<b>Result (minutes)</b>
<p><b>25</b> ref: Sealmaster/WFRC 62398 14/9/94</p>  <p>face exposed to fire</p> <p>Cross pinning Intumescent paper Unbonded joint</p>	<b>30</b>
<p><b>26</b> ref: HRP/TRADA FR 95082 9/9/95</p>  <p>Cross pinning Intumescent paper with plywood veneer face</p>	<b>30</b>
<p><b>27</b> ref: -TRADA D5 4/87</p>  <p>Plain glass 6 mm georgian wired glass 2 mm intumescent strip</p>	<b>30</b>
<p><b>28</b> ref: -TRADA D6 4/87</p>  <p>Intumescent strip Intumescent varnish 6 mm georgian wired glass</p>	<b>30</b>

Note: All doors constructed from softwood unless otherwise stated.

(7 of 7)

▲ FIGURE P.2 Continued

## Annex Q Protection of Iconic Structures (Reserved)

### Annex R NFPA 914 Case Studies

*This annex is not a part of the requirements of this NFPA document but is included for informational purposes only.*

#### R.1 Federal Office Building — Washington DC.

**R.1.1 Introduction.** The Federal Office Building was built in 1888 for the Federal Government. The building occupancy was mainly office although there was a library and a cafeteria. The building had very significant fire and life safety deficiencies typical of construction during that era. These included inadequate exit enclosures, inadequate sprinkler protection, and unenclosed vertical openings. All of these issues were impacted by historic preservation requirements.

The purpose of this case study is to show how the building owner (the Federal Government), the architect and engineering firm (A/E), and AHJ (General Services Administration) for the subject building used NFPA 914 to develop a construction project to ensure that the building and its occupants were protected from the effects of fire and that the historic fabric and integrity of the building were maintained. This project was neither a full building renovation nor building rehabilitation.

The owner of the building completed a building survey and found that the building was not compliant with NFPA 101, nor was the level of safety equivalent to a code compliant building using the FSES scores for business occupancies found in NFPA 101A. This case study indicates the aspects of the building that did not meet NFPA 101 and how NFPA 914 was used to develop a scope of work to provide an acceptable level of safety to the AHJ.

#### R.2 Chapter 7 of NFPA 914.

**R.2.1 Process.** Per Section 7.2 of NFPA 914, a team of individuals was identified to apply the code. Historic preservationists and fire protection engineers were hired as part of an architecture and engineering firm. The firm and the building owner were involved in developing the scope of the project to improve the life safety of the Federal Office Building. The AHJ was involved in all phases of the project, including the development of the scope, design drawing review, and shop drawing review.

Per Section 7.3 of NFPA 914, the building was assessed with regard to both historic preservation and fire protection. The summary of the survey follows.

**R.2.2 Historic Documentation.** To develop the scope of work, the historic preservationist needed to determine the areas of the building that could be altered. The building was divided into three types of areas per floor based on historic significance as follows:

- (1) Restoration Zone 1: Areas not to be altered
- (2) Rehabilitation Zone 2: Areas to be rehabilitated while retaining significant architectural details
- (3) Renovation Zone 3: Areas suitable for major redesign. Zone 1 included the most historically and architecturally significant spaces, including most public areas and high-visibility special use spaces and most user accessible areas such as the main corridors, library, culturally and historically significant rooms, and certain office suites that were extremely important. Zone 2 areas were of secondary

architectural and historical importance but retained details that related to those spaces or areas of greater significance and included typical offices. Zone 3 included basement, attics spaces, utility spaces, and toilet rooms.

**R.2.3 Identification of Fire Safety Issues.** The team gathered to develop the scope of work first identified all of the fire safety deficiencies in the building. The applicable codes used during the survey were the following: NFPA 101, NFPA 70, NFPA 13, NFPA 72, and ASME A.17.1/CSA B44, *Safety Code for Elevators and Escalators*.

**R.2.3.1 Building Description.** The Federal Office Building was an 8-story high-rise building that occupied approximately 1,000,000 ft<sup>2</sup>. The building was shaped like a “figure eight” with corridors around both loops of the “eight” and offices along both the courtyard and street sides of the corridors. The building had 8 monumental staircases that connected the basement through 7th floor. The building construction was Type II (222). The building was classified as a business occupancy per NFPA 101.

A list of the major life safety deficiencies in the building follows:

**R.2.3.2 Exits/Unenclosed Vertical Shafts.** The eight monumental exit stairs that connected the basement through 7th floor were not enclosed by fire barriers. No other stairs were provided for the building. Per NFPA 101, the building was required to have exit stairs enclosed by 2 hour rated fire barriers. Enclosing the monumental stairs would have adversely impacted one of the most significant architectural elements in the building.

The discharge from the monumental stairs was also deficient. All monumental stairs discharged inside the building instead of discharging directly outside as required by NFPA 101.

The egress capacity was also deficient as there were no code compliant exit stairs.

The building corridors were not rated as the doors were historic and had open transoms.

**R.2.3.3 Fire Suppression System.** The building was not protected with an automatic sprinkler system. The building qualified as a high-rise building due to its height above fire department access. Per the IBC, the building was required to be protected with an automatic sprinkler system. Since the building was existing, NFPA 101 required it to be sprinklered or provided with an approved engineered life safety system.

**R.2.3.4 Fire Alarm System.** The building was equipped with a fire alarm system; however, the system audibility did not comply with NFPA 72 as speakers were only installed in the corridors. The plaster corridor wall construction did not permit a sufficient sound level to penetrate into the offices

**R.2.4 Fire Hazards, Safety Deficiencies, and Fire Spread.** The team evaluated the fire hazards and potential for fire spread in the building. No passive fire protection systems (compartmentation) was provided in the building. The electrical system in the building was over 75 years old and was not designed for the typical office electrical load of the 21st century. The electrical system had the potential to be a likely ignition source.

The fuel load was generally consistent with a business occupancy. The team also looked at the fuel load in the library. Due

to the existing fuel load in both the library and offices, flash-over could occur in the room of fire origin, which would likely spread the products of combustion, smoke, and heat into the corridors. Since there was no separation between the corridors and the monumental stairs, smoke and heat could readily spread throughout the building.

**R.2.5 Options.** After the team identified the issues, it evaluated options to correct the deficiencies while considering the historic preservation requirements. The team first looked at prescriptive compliance for each deficiency. Where the prescriptive requirements could not be met, the concept of equivalency was used.

**R.2.5.1 Exits.** In order to meet NFPA 101 for means of egress requirements and shaft enclosure requirements, the eight exit stairs would need to have been enclosed by two hour rated fire barriers. This would have permitted them to be counted as exit stairs and would have eliminated the unprotected vertical opening deficiency as well. This was not a desirable solution as the stairs were an important architectural feature of the building. Therefore, meeting this prescriptive requirement was not considered.

Instead of enclosing the monumental stairs, the team looked for an equivalent method of meeting the intent of the code. The team suggested providing two new code compliant exit stairs that would connect all levels of the building. These two exit stairs discharged directly outside. These two stairs would be located in an existing office with the new entrance door located at an existing door in the main corridor. The new 1½-hour fire protection-rated door would be manufactured to match the existing historical doors. The existing transom glass would be replaced with 1½-hour fire protection-rated glass. The new stair required removal of the floor slab in the area of the new stair. This selective loss of historic fabric, although unfortunate, was deemed necessary to provide a minimum level of safety for the building occupants while having minimal impact on the building's architectural character.

In order to decrease the risk of fire spreading throughout the entire building, the building was divided into thirds by 1½-hour fire-rated horizontal sliding doors. The doors would assure that only one third of the building would be subjected to the products of combustion if a fire were to occur, limiting the spread of fire and protecting occupants in the other two thirds of the building. This would also protect one third of the building occupants from those products of combustion.

**R.2.5.2 Automatic Suppression System.** The team decided that providing an automatic suppression system for the building was essential to improve the level of safety in the building, especially since the vertical openings would not be enclosed. An automatic suppression system would be able to automatically control or extinguish a fire without waiting for the fire department to initiate fire suppression activities. The team considered using a wet pipe sprinkler system throughout the majority of the building and using a water mist system in the various historic preservation zones. Wherever possible, the design team chose to use standard automatic sprinkler protection due to its high reliability, low maintenance, and lower cost.

In the Zone 3 areas of the building (basement, attic spaces and mechanical rooms), a standard wet pipe sprinkler system was designed and installed as this was the most cost effective method of installing automatic suppression and there were no historic preservation concerns.

In the Zone 2 areas (offices of lesser architectural significance), the team investigated how to install an automatic sprinkler system without adversely affecting the historic fabric of the building. The installation of water mist systems was not practical due to the large number of offices in Zone 2 areas. Clean agents would also not have been practical due to the large area requiring protection. Several wet pipe automatic sprinkler system options were investigated. One option was to install the piping exposed just beneath the cornice in the corner of the room. Due to the size and shape of the cornice, the piping could fit in the molding and extended coverage sidewall sprinklers could be used. The ceiling height of the offices was approximately 12 ft. The pipe could be painted to match the walls so that visual integrity was least affected. This option minimized damage to the historic fabric and adverse impact on the architectural character of significant spaces. Due to the location of the pipe up against the bottom of the cornice, the sidewall sprinklers would have been located approximately 23 in. below the ceiling. This distance from ceiling to sprinkler deflector exceeded the listing of all sidewall sprinklers.

Another option was to install the piping inside the cornice. The team determined that if the sprinkler pipe was plastic instead of steel and the size was no larger than 2 in., the piping would fit and be completely hidden in the cornice. This option required the replication of the cornice as the plaster could not be removed and replaced. The locations of the sprinklers did not comply with their listings as the sprinklers were located 20 in. below the ceiling. The team selected this option as the sprinklers were closer to the ceiling than the first option and this option was more esthetically pleasing. Extended coverage sprinklers were used so that only one piping run was required in the offices. This option limited the damage to historic fabric to one wall in each office. Several methods of protection were investigated for the protection of Zone 1 areas, the most architecturally and historically significant areas, such as the hallways, library, and special offices. In the library and certain offices, the use of water mist systems was first investigated. The library had three levels of book shelves with an atrium in the middle. At that time, water mist systems were not listed for use in ordinary group 2 occupancies as defined by NFPA 13. The ability to extinguish deep seated fires, typical of a library, was also a concern.

The design team then investigated methods to install a wet pipe sprinkler system without adversely affecting the library's historic character aesthetically. The team specified a wet pipe automatic sprinkler system using copper pipe. The use of copper pipe minimized the pipe diameter and also allowed it to curve around the wrought iron book shelves. The piping was also painted black so that the visual impact was kept to a minimum.

In the special office areas, the use of water mist systems was investigated. These offices were approximately 2,500 ft<sup>2</sup> in area. Although the tubing could be smaller and therefore more easily hidden, many nozzles would have been required and could not have been concealed. In these areas, the design team found that sprinkler piping could be completely concealed if the piping was fed from the floor above. This arrangement required channeling piping in the wall of the office above. Fortunately, the offices above were not as historically significant so this option was selected.

The design team found that they could provide automatic sprinkler protection to the corridors from the adjacent offices.



Sprinkler piping was fed from the office side and aligned so that a sidewall sprinkler would take the place of a rosette at 15 ft intervals in the corridor. The sprinklers were manufactured to match the wall color.

**R.2.5.3 Fire Alarm System.** The existing building fire alarm system was an addressable system that was acceptable except for the lack of audibility in the office areas. The audibility was augmented by providing new fire alarm speakers in the office areas. Instead of the typical fire alarm installation, horizontal wiring needed to be minimized as wall channeling, which would destroy historic fabric. Therefore all fire alarm speakers were installed in existing vertical shafts. Approximately 70 vertical risers were added to improve fire alarm audibility in the building.

### Annex S Protection of Historic Districts

*This annex is not a part of the requirements of this NFPA document but is included for informational purposes only.*

**S.1 Scope/Introduction.** Historic districts are often the “hub” of a community, bringing economic benefits through tourism and commerce along with providing a sense of identity to the community. This annex sets out a structure within which stakeholders can formally identify said districts and build a fire/security protection plan. There have been numerous fires in historic districts that have spread beyond the building of origin, pointing to a need for guidance in protecting collocated structures. A number of jurisdictions have documented these events in case studies focusing on the unique risks and needs of historic districts. This annex compiles material from several published sources, including the following:

- (1) “Preliminary Report of the Preservation and Fire Protection Task Force to the Bellefonte Borough Council,” March 19, 2007
- (2) *Guide to Fire Safety in Historic Town Centres*, English Heritage, May 2008
- (3) *Can we learn from the heritage lost in a fire? Experiences and practises on the fire protection of historic buildings in Finland, Norway and Sweden*, National Board of Antiquities, Finland, 2004
- (4) COST Action C17: Built Heritage: Fire Loss to Historic Buildings
- (5) Municipality of Skagway, Alaska, Ordinance No. 10-05

Recent fires in the central business areas of historic towns and cities underscore the continued need for specialized fire protection requirements addressing historic districts. Some examples include the following:

- (1) Bellefonte, Pennsylvania 2006
- (2) Chester, UK 2002
- (3) Edinburgh, UK 2002
- (4) Trondheim, Norway 2001

These fires were serious or had the potential to become even more so because of various common factors, including the following:

- (1) Fire spread to adjoining buildings, often at roof level, occurring for any of a number of reasons, such as hidden voids, common roof spaces, proximity of the adjacent structures, or collapse, allowing direct impingement of flames
- (2) Difficult vehicle access for the fire department into the neighborhoods and in the buildings

- (3) Late detection of the fire and therefore late notification to the fire department, leading to well-established fires on arrival of fire fighters
- (4) Strong winds

Building codes, fire codes, and life safety codes tend to deal with individual properties as separate entities with little or no consideration of the impact on neighboring properties.

Each historic district is a unique expression of the cultural heritage of a community, and individual owners within the district have the unique responsibility of protecting not only their property but also the property of their neighbors. Whatever the value that a community places on the preservation of their historic district, be it of monumental national or local historic significance that is important to the sustainability of a community or both, preservation of a historic district can be challenging. Typically, preservation of a historic district with multiple owners and a variety of significance factors, occupancy types, and many different construction types is not an easy task. Stewardship requires taking into account the political realities of the jurisdiction, relative historic significance, economic resources of the owners and the community, and a balance between technology and its impact upon the historic buildings and landscape.

**S.2 Political and Private Constraints and Opportunities.** A principal constraint to developing a historic district and the necessary fire and security protection plan is achieving consensus from the local community despite the far-reaching benefits of this endeavor. When consensus is not possible, hard political decisions might be required.

Political restraints often include restraints on budgets. However, this need not be a major issue since there is considerable work that could be done at little or no cost to improve fire protection in a historic district. Basic fire awareness, good “community” housekeeping, and basic infrastructure maintenance can all provide improvements without a major investment. Funding opportunities might exist through state, provincial, local, or national grants that are available for fire, security protection, and safety. There might also be tax incentives or insurance benefits to help cover the cost of the improvements.

Private restraints can come from a perceived invasion of private property rights, fear of additional expenditures, fear of displacement and gentrification, apathy, development pressure, and lack of awareness of the significance of historical resources. Also, owners who have already met the minimum requirement of life safety codes might not be prepared to invest further to improve fire protection beyond their own property. This can be particularly prevalent where there is a high turnover of owners within the historic district.

**S.3 Stakeholders.** Historic districts are important because of their significance to the community beyond the owners of property within the district. Therefore, a fire protection program for a historic district requires the support of not only the owners, but the broader community. This group should be as wide ranging as possible and should investigate ways to improve fire protection and mitigate the effects of an event. The members of the group will depend to a certain extent on local circumstances. Potential stakeholders include the following:

- (1) Fire department
- (2) Mayor, town administrator, and local council

- (3) Chamber of commerce
- (4) Property owners
- (5) Tenants
- (6) Citizens (community at large)
- (7) Architects
- (8) Historic preservation specialist
- (9) Building officials
- (10) Insurers
- (11) Fire protection engineer
- (12) Structural engineer
- (13) Fire protection systems contractors

**S.4 Establishing a Historic District.** As an illustrative example, in the United States, the National Register of Historic Places (NRHP) defines a historic district per U.S. federal law as “a geographically definable area, urban or rural, possessing a significant concentration, linkage, or continuity of sites, buildings, structures, or objects united by past events or aesthetically by plan or physical development. In addition, historic districts consist of contributing and non-contributing properties. Historic districts possess a concentration, linkage or continuity of the other four types of properties. Objects, structures, buildings and sites within a historic district are usually thematically linked by architectural style or designer, date of development, distinctive urban plan, and/or historic associations.” For example, the largest collection of houses from 17th and 18th century America are found in the McIntire Historic District in Salem, Massachusetts. Some NRHP-listed historic districts are further designated as National Historic Landmarks, and termed National Historic Landmark Districts. All National Historic Landmarks are NRHP-listed.

A contributing property is any building, structure, object, or site within the boundaries of the district that reflects the significance of the district as a whole, either because of historic associations, historic architectural qualities, or archaeological features. Another key aspect of the contributing property is historic integrity. Significant alterations to a property can damage its physical connections with the past, lowering its historic integrity. As a whole, historic districts ought to be viewed as a collection of artifacts thereby allowing for a range of appropriate protective measures commensurate with the relative value of individual contributing properties.

Typically, historic districts are designated in accordance with the National Register of Historic Places or the listing process of the United Kingdom. However, in the United States, districts can also be designated by local community action. A community might designate a property as worthy of protection because of its special and unique importance. First actions might include the following:

- (1) Adoption of a local preservation ordinance, with provisions for protecting the historic district, creating a local review board, and preparing protective covenants and design guidelines
- (2) Creation of an overseeing preservation commission

There are numerous associated advantages to establishing a historic district, including the following:

- (1) To provide a level of protection for a resource determined important to the nation, region, or local community.
- (2) Better protect the investments of the owners, residents, and government. Visitor associations, real estate agents, chambers of commerce, and others can use historic

district status as a marketing tool to attract buyers and visitors with some assurance that the character of a particular area will be protected over time.

- (3) It will encourage better design. Comparative studies have shown that there is a greater sense of relatedness, more innovative use of materials, and greater public appeal within historic districts than in areas without historic designations.
- (4) The educational benefits of creating historic districts are the same as those derived from any historic preservation effort. Districts can help explain the development of a place, the source of inspiration, and technological advances.
- (5) A historic district that is aesthetically cohesive and well promoted can be a municipality’s most important attraction resulting in a positive economic impact from tourism.
- (6) Protected local historic districts can enhance business recruitment potential. Companies do relocate to communities that offer their workers a higher quality of life, which is greatly enhanced by successful local preservation programs and stable historic districts.

**S.5 Preservation Ordinance and Commissions.** A preservation ordinance is local legislation created to protect buildings and neighborhoods from destruction or thoughtless rehabilitation. In general, local laws are more focused and site-specific than federal laws, so a local historic preservation ordinance provides the real defense against inappropriate exterior remodeling and demolition within the historic district. Its special strength comes as the combined voice of residents, the majority of who agreed to use local laws as a tool to preserve the historic character of their homes, businesses, and streetscapes. Open discussion and debate of all affected by the process is crucial to its success. A preservation ordinance does such things as establish an objective and democratic process for designating historic properties, protecting the integrity of designated historic properties within a design review requirement, and authorize design guidelines for any new development within historic districts to ensure it is not destructive to the area’s historic character. Generally, a local preservation ordinance does not restrict the sale of the property, require improvements, changes, or restoration of the property, prevent new construction in historic areas, or require approval of interior alterations or ordinary maintenance. Historic district commissions operate at the local level. Sometimes they are referred to as the architectural review board or the historic preservation commission. Appointed bodies or commissions typically oversee surveys, designate locally significant properties, and administer permit programs for applications to alter designated properties and construct new buildings.

**▲ S.6 Goals of Protection.** Fire safety and security goals and objectives should be adopted that reflect the level of loss and interruption of service to the client community that those responsible for the historic district are willing to accept as a result of a fire, from the simplest to the most complex:

- (1) Limit loss to a portion of a building
- (2) Limit loss to a building
- (3) Limit loss to a group of buildings
- (4) Chapter 4 of NFPA 914 states:

“The goals of this code shall be to provide protection against vulnerabilities to hazards for historic structures or historic districts and their occupants while protecting those elements, spaces, and features that make the structures historically or

architecturally significant and allow for continuity of operations. The goals shall be accomplished by operational approaches, system approaches, or the consideration of other factors, and shall include all of the following:

- (1) To provide reasonable safeguards for protection of property and the preservation of historic finishes, spaces, and architectural elements from the damaging effects of fire and security vulnerabilities
- (2) To provide for the protection and life safety of occupants not intimate with the initial fire development and improve the survivability of occupants intimate with the initial fire development
- (3) To provide an environment that is reasonably safe from security threats for the occupants inside or near a building
- (4) To maintain the historic fabric and integrity of the building
- (5) To provide for continuity of operations”

This annex has an additional goal of preserving the character of a historic district through a process of:

- (1) Education
- (2) Enforcement
- (3) Technical opportunities
- (4) Government commitment
- (5) Community involvement

**S.7 Proactive Education Program.** In addition to the training and drills identified within Chapter 10 of this code, the key to a fire safe community is a proactive educational program. Any such program should focus on the importance of the historic district to the community. By providing an awareness of potential fire and security hazards, most threats can be addressed through simple fire prevention and security measures, including the following:

- (1) Information provided to owners and the community through meetings and the distribution of leaflets
- (2) Advice on how to prevent fire spreading from building to building
- (3) An awareness of arson and the need to consider security and the safe storage of combustible materials in or near the building
- (4) Control of contractors responsible for any hot work
- (5) Ensuring that electrical appliances and installations are maintained
- (6) Control of open flames, candles, smoking materials, cooking, and open fires
- (7) Consideration of fire protection systems for individual properties and, more broadly, in the historic district itself

**S.8 Initiating a Historic District Fire Protection Program.** The initiative for a fire protection program that concerns a historic district usually comes from the AHJ. An initial fire vulnerability survey of the buildings in the historic district should be undertaken to determine which premises have the benefit of fire separation, and automatic detection. The AHJ, using the fire department, its own staff, insurance surveys, or a hired consultant, would normally undertake this survey and then make proposals on how to improve fire protection in order to achieve the set goals.

The actions can be divided into two categories: administrative measures that the municipality must implement and the technical measures that can be carried out by the municipality or property owners. The municipality can carry out administra-

tive measures, such as action plans for the fire department, frequent fire drills, fire inspections, and the coordination of training.

Training of property owners and users is one of the most fruitful ways to begin a district protection program.

It is important that the owners and occupants understand that it is not only their problem if a fire breaks out in their single building located in a tightly packed historic district. Conversely, a fire originating in a nearby building poses a threat to their property and safety. Effective fire and security protection for collocated structures under separate ownership depends on consensus that it is a shared concern and responsibility requiring the cooperation of all historic district property owners.

Training can be carried out in many ways. Articles in the local newspapers, informative meetings, information leaflets and letters addressed to the owners can all be used. Practical training on how to use fire extinguishers or fire hoses can be considered as a way to improve fire safety and to add to the knowledge among owners and users.

The following matters should be considered when planning and implementing a fire protection program for a historic district:

- (1) What is the goal of the program?
- (2) What kinds of risks are there on single properties in the district and how they can be minimized?
- (3) What are the risks of a fire spreading from one block to a neighboring one and how can those risks be minimized? How can the fire be limited to a restricted area?
- (4) What can be done to detect fire as early as possible?
- (5) What problems does the fire department face when accessing the district and acting in a district structure or on single buildings?
- (6) Is there enough water to extinguish the fire?
- (7) How can joint training in fire protection be arranged for owners and occupants?
- (8) What measures should the municipality take and which should be left to property owners?
- (9) What kinds of risks are there to neighboring structures in the district and how can they be minimized?

### S.9 Technical Standards and Opportunities.

**△ S.9.1 First Level — Inspection and Housekeeping.** An initial survey of the district as a whole, and each individual premises in the historic district should be undertaken to determine where there are deficiencies in the passive fire protection, especially the boundary fire separation, either in the form of party walls or space separation (e.g., gaps in exterior finishes or around pillars or other chases that allow the buildup of discarded smoking materials and other combustibles). The survey should also determine which premises have the benefit of automatic detection, sprinklers or other active fire protection.

Property owners should receive a fire safety checklist, and regular checks should be made to ensure that easy, low-cost measures (such as storage of waste, removing combustible material, tidiness, etc.) are implemented.

**S.9.2 Second Level — Inspection Document.** The fire safety inspection forms included in Annex J can be used or adapted for the inspection of buildings within historic districts. In addition, in the protection of a historic district, the lateral spread of

fire between buildings presents an additional hazard and should be addressed in the inspection checklist.

**S.9.3 Third Level ■ Engineering/Technical Systems and Tools.** Based on the initial survey of each premises, a list of systems, technologies, and tools for addressing deficiencies for individual properties and the district as a whole should be developed, including, but not limited to automatic detection, sprinklers or other active fire protection systems.

In historic districts where income levels, rental revenues, or property values might be inadequate to support owner investment in sprinkler systems or other technology, legislation authorizing government financial assistance or tax credits might be considered. In this regard, the borough of Skagway, Alaska, adopted Ordinance No. 10-05 in 2005, which provided a financial incentive in the form of matching grants over a 7-year period for the express purpose of installing individual building fire sprinkler systems within the bounds of the historic business district. Grant approvals were predominantly based on recommendations obtained in a 1989 Management Development Institute consultant's report to the borough. This program proved to be very successful in part due to an additional mandatory retroactive requirement to sprinkler all remaining buildings in the historic district at the sunset of the grant program.

Norway provides us with two examples in which engineered solutions have been provided to restrict the spread of fire in historic districts.

The historic wooden town of Bergen in Norway has had sprinkler systems fitted both internally and externally since a disastrous fire destroyed many of the buildings in 1978. This has successfully limited the spread of fire ever since.

The pipes are colored the same as the buildings and are therefore quite discreet. The World Heritage Site of Røros, also in Norway, is a wooden town, which could not be protected by sprinklers because of the cold winters. Here, some of the roof voids are being protected by a dry low-pressure water mist system, with the water supplied by the fire department via a fixed inlet. The system is designed to prevent flashover in the roof, which stops high level fire spread to adjoining premises.

The fire protection of Røros has been funded mainly with government money (through Riksantikvaren, Directorate for Cultural Heritage). Riksantikvaren has also given grants for the protection of other important dense wooden towns and villages. Fire protection of historic wooden towns also rely largely on funding through the municipalities.

**S.10 Enforcement Issues.** The AHJ should actively promote and adopt a life safety code or fire prevention code in conjunction with NFPA 914, which will make their application more appropriate for historic buildings.

**S.11 Case Studies.** The following case studies cover representative fires that have occurred within historic districts together with an outline of plans that have been developed as a result of these incidents. They are provided to highlight the very real threat to historic districts from the effects of fire while demonstrating that the principles of fire protection within historic districts, as identified within this annex, have been adopted by these communities only following these unfortunate events.

**S.11.1 City Block in Trondheim, Norway.** Trondheim is a medieval city. It was replanned in 1681 with a Renaissance town

plan with broad streets to prevent the spread of fire. The block damaged in 2001 had buildings dating from the 1840s. The block includes some stone cellars from the Middle Ages. The buildings were primarily used as restaurants, bars, and shops. Most of the buildings had walls of wooden log construction, wooden cladding, wooden floors and roof construction, and basements of brick. The area was not a conservation area but the buildings had been defined as worth preserving by the municipality.

**S.11.1.1 December 7, 2001, Fire.** The fire started in a pan of hot cooking oil in a restaurant kitchen. A couple of days before the fire, there were some indications of problems with the electrical installations in the restaurant. Fluctuations in the power supply might have caused a failure in the pan thermostat. The fire was reported to the fire department at 10:45 a.m. The cook tried to extinguish the fire without success. All available personnel from the fire department were on site before 11:00 a.m. The Trondheim fire department also got assistance from fire departments in the neighboring municipalities and from the military. There was an automatic fire detection system in the restaurant. According to the fire instructions, this was only in operation between 4:00 a.m. and 8:00 a.m. when there was nobody in the restaurant. There was also an automatic sprinkler system in the restaurant kitchen. The fire department turned off the sprinklers, thinking the fire was extinguished. The fire, however, had spread to the ventilation room in the floor above the restaurant. The fire spread from the ventilation room along the facades and through the lofts. There was a shared ventilation system with ventilation ducts in several of the buildings. Many of these buildings lacked firewalls between the lofts. It took the fire department hours to stop the fire spreading to the remaining part of the block. A wall of solid wood construction in one of the buildings stopped the spread of the fire. A large concrete building was also seriously damaged, but the fire department managed to stop the fire there.

**S.11.1.2 Problems Identified.** Problems that were identified as contributing to the fire included the following:

- (1) The fire department lacked knowledge of the properties.
- (2) The available fire-fighting personnel were not used effectively.
- (3) The fire department lacked modern fire-fighting equipment.
- (4) The fire department lacked safe access to back yards.
- (5) There was insufficient fire insulation, particularly in the lofts.
- (6) A sprinkler valve in one of the buildings was turned off.
- (7) The building authorities lacked an overview of the fire safety of the properties.
- (8) The building authorities had not used their authority to make sure the reported lack of fire protection was improved.

**S.11.1.3 Steps Taken to Prevent Subsequent Fires.**

- (1) The local authorities will carry out a risk analysis for fire protection.
- (2) The fire department will be strengthened, particularly the department working with prevention.
- (3) There will be improved routines for fire protection during the building planning process.
- (4) There will be improved cooperation between fire-fighting personnel and fire officers.
- (5) There will be improved routines for fire inspections.

- (6) There will be a project for the fire protection of the historic center of Trondheim, including a survey of all the properties.

**S.11.2 The Rows, Chester, UK.** Although the townscape and architectural history of Chester's historic core have much in common with other historic towns and cities, the city's row system is unique. The Rows comprise a continuous system of galleried buildings along the four principal streets. From the street frontage they are presented today as two tiers of retail premises. The ground slopes up from the street so that the undercrofts which generally form the street level units are at, or just below ground level to the front but are entirely underground to the rear. The story above is at ground level to the rear but at first floor level above the street. It is here that adjoining buildings are linked to form the Row walkway that provides a second and covered right of way to the street.

Their origins have been the subject of much debate. It is suggested that when the Saxons resettled the ruined Roman town, they maintained the Roman streets at their original and surviving level but constructed their buildings atop the rubble of the Roman remains within which they constructed useful storerooms. Others suggest the Rows result from a deliberate act of early town planning. Following the conflagration of the city in 1278, merchants were ordered to make their ground floors fireproof, and it is clear that the present character and extent of the Rows was established and formalized at that time.

**S.11.2.1 January 2002 Fire.** The potentially catastrophic consequences of fire within Chester's unique row system were demonstrated during January of 2002. Fire broke out in 61 Bridge Street, 71-73 Bridge Street Row, a typical Georgian row townhouse. The building was in retail use, with separate shop units to street and row level. Above row level the building was occupied by a bridal wear company with both retail and workshop areas.

The fire is thought to have broken out in these premises, most likely within the workshop area. The fire developed during the evening, but the alarm was raised only at midnight by which time the building was thoroughly ablaze. The property was not provided with any form of fire detection system and the alarm was only raised once the fire had broken through the roof structure and the residents of the flats in the adjoining premises raised the alarm.

More than 60 fire-fighters attended the incident. They were able to fight the fire on two fronts, both from the street and the network of alleys to the rear of this part of the Row. Despite better access arrangements than elsewhere on the row, the favorably calm weather conditions and the cooling of adjoining properties, the fire spread across the roofs to adjoining properties at 59 Bridge Street and 67-69 Bridge Street Row.

**S.11.2.2 Problems Identified.** The Bridge Street fire was thought to have started in number 61 and to have burned for some time before it was noticed by a neighbor, who called the fire service. It was therefore well developed before the first call was received.

The access to the fronts of the properties is at Row level, which is above street level. This meant that the fire fighters had to take all their equipment up the narrow steps to the walkway or by ladder to the floor above.

The fire service successfully prevented further spread, because they were able to get to the rear of the buildings, via

alleyways. This would not have been possible if the fire had occurred further up the Row where the buildings are land-locked.

**S.11.2.3 Steps Taken to Prevent Subsequent Fires.** Following the fire, the financial implications became apparent, both direct losses and the subsequent fall off in trade for surrounding businesses. A multidiscipline group called the Rows Fire Safety Group was set up to investigate ways of improving fire safety and mitigate the effects of any future fires.

The group recommended a series of no-cost actions, including the following:

- (1) A survey of the current fire safety arrangements, including fire protection systems, was undertaken within the individual premises making up the Rows.
- (2) The fire department surveyed the boundaries of the premises to see where there were deficiencies in the passive fire protection, especially the boundary fire separation.
- (3) A system of maintaining and regulation of both trade and domestic waste has been put in place. Refuse collection times have been altered to reduce the likelihood of waste materials being left in the Row.
- (4) There is now a regular inspection regime by the City Council to identify defects and issue notices of repair.
- (5) A hot work permit system for any use of blow torches, etc, on the Row has been initiated.
- (6) A smoking ban on the Row has been implemented.

The group also considered improvements to fire protection systems.

The cost of providing sprinkler systems for every property was investigated and was less than the losses incurred as a result of the fire in Bridge Street. However, the properties are almost all in multiple occupancy, and it is difficult to persuade responsible persons to pay for a sprinkler system when the means of escape is satisfactory and there is therefore no legislative requirement. The provision of suppression systems might be a long-term solution, but a quick-fix solution is required and to which end the provision of detection has been considered.

The Rows Fire Safety group was keen to implement some preliminary fire protection to all the premises within the Rows and considered setting up a radio network linked to the city control room. This would enable radio-linked fire detection to be provided in all roof voids of premises currently without fire detection systems. Those premises already provided with a detection system not currently monitored could also have their system radio linked to the control room.

By 2008 the provision of detectors in the roof voids had not been started, but a detailed radio signal survey had been completed to establish suitable locations for placing indicator panels. These indicator panels are monitored by a call receiving center via three monitoring lines which are capable of monitoring the complete Rows fire detection system. The system can be linked to existing fire alarm systems through an interface with monitoring offered by Chester City Council.

The Rows have now been provided with about 4000 ft (1219 m) of line detection (heat loop) along the most vulnerable sections. This will detect a fire in the Rows walkway or when heat escapes from one of the premises at this level.

**S.11.3 Edinburgh Old Town, UK.** The historic center of Edinburgh, including the Old Town, of which the present plan has its origins in the 12th century, and the New Town, which began in the mid-18th century, was inscribed on the World Heritage Sites list in 1995 on the basis of cultural criteria (ii) and (iv) as it represents a remarkable blend of the two urban phenomena: organic medieval growth and 18th and 19th century town planning.

The fire-damaged site forms the historical suburb of the Old Town of Edinburgh and is bounded by the Cowgate, South Bridge, Guthrie Street, Hasties Close, and Chambers Street. The properties vary in height from one to seven stories, including conversions and subdivision of a large department store to commercial, leisure and domestic habitation. The buildings were of traditional construction, mainly stone and timber with both pitched slate roofs and modern flat roofs with asphalt coverings.

**S.11.3.1 December 7, 2002, Fire.** On the night of December 7, 2002, appliances of the Lothian and Borders Fire Brigade were mobilized to what was to become one of the largest fires in the Brigade's history. The fire involved 5 interlinked buildings containing 13 premises, which included licensed premises, nightclubs, shops and offices. Over a number of years renovation had taken place within a number of buildings that had resulted in knock-through access between buildings for persons and additional services. In addition, there were numerous void/ducted areas that ran vertically and laterally throughout many of the buildings. These renovations inevitably played a major part in the very rapid spread of fire throughout the buildings.

Due to the extensive building(s) footprint and the congested nature of access it was decided to concentrate fire-fighting efforts in surrounding the fire and minimizing fire spread to adjacent heritage buildings with fire-fighting operations continuing throughout the night.

At the incident's height, 12 pumping appliances, 5 height appliances, and 2 specialist appliances attended the Cowgate and South Bridge with over 80 fire fighters tackling the fire. The Brigade's command structure was instigated, resulting in the mobilization of 24 senior officers over the weekend.

**S.11.3.2 Problems Identified.** The rapid development and spread of fire may have been restricted to a smaller area, or avoided, had adequate barriers including building separation, fire-stopping and fire compartments been in place. The lack of suitable stopping led to unrestricted fire spread throughout the adjoining properties, both vertically and laterally. The fire continued via large void areas, some 3 ft (0.9 m) in depth, at floor and ceiling levels and through openings in walls, such as doors and windows which were inadequately fire-stopped or enclosed during changes to the properties. These changes included the conversion, of what appeared to have been a courtyard bounded by old tenement properties, into licensed premises. The rapid unseen spread of fire and the dangerous conditions that were developing within the first floor level and surrounding area resulted in the emergency evacuation of all the building and the **resiting** of all fire-fighting appliances to a safer area.

During the investigation it was noted that a sprinkler system had been **decommissioned** during renovations and conversions for the change of use to places of entertainment. Had the system remained in place, and been fully operational, the fire

damage to the surrounding properties would have been significantly reduced.

The fire was eventually detected by automatic smoke detectors in a remote area of the surrounding properties owned by Edinburgh University. Had smoke detection been installed throughout the premises of the Living Room Public House the additional early warning may also have reduced the damage to the surrounding properties.

The actuation of the manual fire warning system installed in the premises resulted in the safe evacuation of all members of staff and members of the public.

**S.11.3.3 Steps Taken to Prevent Subsequent Fires.** Lothian and Borders Fire Brigade identified that collaboration of fire safety officers, Planning and owners of premises and buildings where similar conditions may exist should continue beyond legislative requirements of individual properties. This collaboration should involve adjoining properties even if they fall out with any formal or legal remits, and should include the City of Edinburgh Council, City Development, Building Control and Planning Departments.

**S.11.4 Bellefonte, Pennsylvania.** Established in 1795 and home to five Pennsylvania governors, Bellefonte retains a warm Victorian enchantment. Renowned for its graceful architecture, from lovingly maintained private homes to stately public buildings, Bellefonte proudly maintains its ties to the past. One significant building, constructed in 1869 was the Bush House "ranked as one of the most perfectly appointed and commodious hotels in central Pennsylvania."

**S.11.4.1 8 February 2006 Fire.** On February 8, 2006, at 7:00 a.m., the Bellefonte Fire Department was dispatched for a building fire at the historic Bush House hotel.

On arrival, fire department personnel reported a working fire and called for a second alarm.

An interior attack was attempted. However, after a partial collapse of the roof towards the rear of the structure all personnel were evacuated and an exterior attack was ordered.

Fire companies from Centre County, Mifflin County, and Clinton County battled the blaze for over 8 hours.

In addition to the hotel, the building housed several other businesses including a restaurant, bar, and liquor store, all of which were a total loss.

**S.11.4.2 Problems Identified.** There were not any specific issues with the Bush House fire. Bellefonte lost some very important historic structures prior to the Bush House fire but those were out of the central business district. When the Bush House burned it was literally the heart of the town and this really highlighted the importance of the historic district to the borough and the need to protect it from further fires.

**S.11.4.3 Steps Taken to Prevent Subsequent Fires.** The fire department was asked to provide information to the borough council on means to prevent future losses. They selected a committee of subject matter experts to review the current fire problem in the historic district and propose an initiative to reduce the risk of future large loss fires. The goal of the committee, which was named the Bellefonte Preservation and Fire Protection Task Force (Task Force), was to prevent destructive fires in historic Bellefonte and provide the highest degree of life safety possible, while still preserving the town's

historic character and retaining the architectural integrity of the individual buildings to the highest degree possible. The Task Force developed the following recommendations:

- (1) Education of the community about fire hazards, risk management, fire suppression, and the benefits of fire safety improvements to property owners and occupants
- (2) Engineering of better systems for preventing destruction by fire
- (3) Enforcement of codes and ordinances designed for that purpose.

After hosting an educational workshop on the subject, the Task Force reviewed existing codes and regulations, conducted an assessment of properties in downtown Bellefonte and its infrastructure to identify high priority concerns, and planned fire prevention measures.

Based on the information gathered, the Task Force and the borough was able to plan the next steps in the fire safety initiative and started formulating a long-range plan to preserve the historic district in Bellefonte.

#### **Annex T Example Code Exceptions for Historic Buildings**

*This annex is not a part of the requirements of this NFPA document but is included for informational purposes only.*

**Δ T.1 Introduction.** Modern building and fire safety codes contain chapters that deal with existing buildings. These chapters typically allow for exceptions where the building has been designated as historic. The following is extracted from Chapter 43 of NFPA 101 as an example of some of the conditions that building and fire safety codes allow in historic buildings. Note that these provisions may be in addition to exceptions that are permitted in other (non-historic) existing buildings (i.e., in other sections of the code). A careful reading of the prevailing code is necessary to determine what allowances can be made.

Although the following contains mandatory language, it is an example only and is NOT a part of the mandatory requirements of NFPA 914.

#### **43.10 Historic Buildings.**

##### **43.10.1 General Requirements.**

Historic buildings undergoing rehabilitation shall comply with the requirements of one of the following:

- (1) Section 43.10 (2)
- (2) Sections 43.3, 43.4, 43.5, 43.6, and 43.7, as they relate, respectively, to repair, renovation, modification, reconstruction, and change of use or occupancy classification
- (3) NFPA 914

##### **43.10.2 Evaluation.**

A historic building undergoing modification, reconstruction, or change of occupancy classification in accordance with the requirements of Chapter 43 shall be investigated and evaluated as follows:

- (1) A written report shall be prepared for such a building and filed with the authority having jurisdiction by a registered design professional.
- (2) If the subject matter of the report does not require an evaluation by a registered design professional, the authority having jurisdiction shall be permitted to allow the

report to be prepared by a licensed building contractor, electrician, plumber, or mechanical contractor responsible for the work.

- (3) The licensed person preparing the report shall be knowledgeable in historic preservation, or the report shall be coauthored by a preservation professional.
- (4) The report shall identify each required safety feature in compliance with Chapter 43 and where compliance with other chapters of this code would be damaging to the contributing historic features.
- (5) The report shall describe each feature not in compliance with this code and demonstrate how the intent of this code is met in providing an equivalent level of safety.
- (6) The local preservation official shall be permitted to review and comment on the written report or shall be permitted to request review comments on the report from the historic preservation officer.
- (7) Unless it is determined by the authority having jurisdiction that a report is required to protect the health and safety of the public, the submission of a report shall not be required for a building that is being rehabilitated for the personal use of the owner or a member of the owner's immediate family and is not intended for any use or occupancy by the public.

#### **43.10.3 Repairs.**

Repairs to any portion of a historic building shall be permitted to be made with original or like materials and original methods of construction, except as otherwise provided in Section 43.10.

#### **43.10.4 Repair, Renovation, Modification, or Reconstruction.**

##### **43.10.4.1 General.**

Historic buildings undergoing repair, renovation, modification, or reconstruction shall comply with the applicable requirements of Sections 43.3, 43.4, 43.5, and 43.6, except as specifically permitted in 43.10.4.

##### **43.10.4.2 Replacement.**

Replacements shall meet the following criteria:

- (1) Replacement of existing or missing features using original or like materials shall be permitted.
- (2) Partial replacement for repairs that match the original in configuration, height, and size shall be permitted.
- (3) Replacements shall not be required to meet the requirements of this code that specify material standards, details of installation and connection, joints, or penetrations; or continuity of any element, component, or system in the building.

##### **43.10.4.3 Means of Egress.**

Existing door openings, window openings intended for emergency egress, and corridor and stairway widths narrower than those required for nonhistoric buildings under this code shall be permitted, provided that one of the following criteria is met:

- (1) In the opinion of the authority having jurisdiction, sufficient width and height exists for a person to pass through the opening or traverse the exit, and the capacity of the egress system is adequate for the occupant load.

- (2) Other operational controls to limit the number of occupants are approved by the authority having jurisdiction.

#### 43.10.4.4 Door Swing.

Where approved by the authority having jurisdiction, existing front doors shall not be required to swing in the direction of egress travel, provided that other approved exits have sufficient egress capacity to serve the total occupant load.

#### 43.10.4.5 Transoms.

In fully sprinklered buildings of hotel and dormitory occupancies, apartment occupancies, and residential board and care occupancies, existing transoms in corridors and other fire resistance-rated walls shall be permitted to remain in use, provided that the transoms are fixed in the closed position.

#### 43.10.4.6 Interior Finishes.

##### 43.10.4.6.1

Existing interior wall and ceiling finishes, in other than exits, shall be permitted to remain in place where it is demonstrated that such finishes are the historic finish.

##### 43.10.4.6.2

Interior wall and ceiling finishes in exits, other than in one- and two-family dwellings, shall meet one of the following criteria:

- (1) The material shall have a flame spread classification of Class C or better.
- (2) Existing materials not meeting the minimum Class C flame spread criteria shall be surfaced with an approved fire-retardant paint or finish.
- (3) Existing materials not meeting the minimum Class C flame spread criteria shall be permitted to be continued in use, provided that the building is protected throughout by an approved automatic sprinkler system.

#### 43.10.4.7 Stairway Enclosure.

##### 43.10.4.7.1

Stairways shall be permitted to be unenclosed in a historic building where such stairways serve only one adjacent floor.

##### 43.10.4.7.2

In buildings of three or fewer stories, exit enclosure construction shall limit the spread of smoke by the use of tight-fitting doors and solid elements; however, such elements shall not be required to have a fire rating.

#### 43.10.4.8 One-Hour Fire-Rated Assemblies.

Existing walls and ceilings shall be exempt from the minimum 1-hour fire-resistance-rated construction requirements of other sections of this code where the existing wall and ceiling are of wood lath and plaster construction in good condition.

#### 43.10.4.9 Stairway Handrails and Guards.

##### 43.10.4.9.1

Existing grand stairways shall be exempt from the handrail and guard requirements of other sections of this code.

#### 43.10.4.9.2

Existing handrails and guards on grand staircases shall be permitted to remain in use, provided that they are not structurally dangerous.

#### 43.10.4.10 Exit Signs.

The authority having jurisdiction shall be permitted to accept alternative exit sign or directional exit sign location, provided that signs installed in compliance with other sections of this code would have an adverse effect on the historic character and such alternative signs identify the exits and egress path.

#### 43.10.4.11 Sprinkler Systems.

##### 43.10.4.11.1

Historic buildings that do not conform to the construction requirements specified in other chapters of this code for the applicable occupancy or use and that, in the opinion of the authority having jurisdiction, constitute a fire safety hazard shall be protected throughout by an approved automatic sprinkler system.

##### 43.10.4.11.2

The automatic sprinkler system required by 43.10.4.11.1 shall not be used as a substitute for, or serve as an alternative to, the required number of exits from the facility.

#### 43.10.5 Change of Occupancy.

##### 43.10.5.1 General.

Historic buildings undergoing a change of occupancy shall comply with the applicable provisions of Section 43.7, except as otherwise permitted by 43.10.5.

##### 43.10.5.2 Means of Egress.

Existing door openings, window openings intended for emergency egress, and corridor and stairway widths narrower than those required for nonhistoric buildings under this code shall be permitted, provided that one of the following criteria is met:

- (1) In the opinion of the authority having jurisdiction, sufficient width and height exists for a person to pass through the opening or traverse the exit, and the capacity of the egress system is adequate for the occupant load.
- (2) Other operational controls to limit the number of occupants are approved by the authority having jurisdiction.

##### 43.10.5.3 Door Swing.

Where approved by the authority having jurisdiction, existing front doors shall not be required to swing in the direction of egress travel, provided that other approved exits have sufficient capacity to serve the total occupant load.

##### 43.10.5.4 Transoms.

In corridor walls required to be fire rated by this code, existing transoms shall be permitted to remain in use, provided that the transoms are fixed in the closed position and one of the following criteria is met:

- (1) An automatic sprinkler shall be installed on each side of the transom.
- (2) Fixed wired glass set in a steel frame or other approved glazing shall be installed on one side of the transom.



#### 43.10.5.5 Interior Finishes.

Existing interior wall and ceiling finishes shall meet one of the following criteria:

- (1) The material shall comply with the flame spread classification of other sections of this `code` applicable to the occupancy.
- (2) Materials not complying with 43.10.5.5(1) shall be permitted to be surfaced with an approved fire-retardant paint or finish.
- (3) Materials not complying with 43.10.5.5(1) shall be permitted to be continued in use, provided that the building is protected throughout by an approved automatic sprinkler system, and the nonconforming materials are substantiated as being historic in character.

#### 43.10.5.6 One-Hour Fire-Rated Assemblies.

Existing walls and ceilings shall be exempt from the minimum 1-hour fire resistance-rated construction requirements of other sections of this `code` where the existing wall and ceiling are of wood lath and plaster construction in good condition.

#### 43.10.5.7 Stairs and Handrails.

##### 43.10.5.7.1

Existing stairs and handrails shall comply with the requirements of this `code`, unless otherwise specified in 43.10.5.7.2.

##### 43.10.5.7.2

The authority having jurisdiction shall be permitted to accept alternatives for grand stairways and associated handrails where the alternatives are approved as meeting the intent of this `code`.

#### 43.10.5.8 Exit Signs.

The authority having jurisdiction shall be permitted to accept alternative exit sign or directional exit sign location, provided that signs installed in compliance with other sections of this `code` would have an adverse effect on the historic character and such alternative signs identify the exits and egress path.

#### 43.10.5.9 Exit Stair Live Load.

Existing historic stairways in buildings changed to hotel and dormitory occupancies and apartment occupancies shall be permitted to be continued in use, provided that the stairway can support a 75 lb/ft<sup>2</sup> (3600 N/m<sup>2</sup>) live load.

### Annex U Security Systems

*This annex is not a part of the requirements of this NFPA document but is included for informational purposes only.*

**U.1 Introduction.** Fire protection and security are interrelated. The installation of an electronic security system within the premises is part of the built environment. How it operates with other systems within the same building is integral to the complete protection platform that may be installed. Owners and operators of cultural facilities should involve professionals with experience in the application of security features and systems to buildings. This annex provides a brief overview of premises security systems that are covered by two NFPA documents: NFPA 730 and NFPA 731.

The designer of premises security systems should be familiar with NFPA 730 and NFPA 731, as well as many other publications available through the literature. Practitioners need to be as familiar with the concepts and principles of security as fire protection engineers are with their skill set. The consequences of a poor design for security systems can be just as devastating to the collection, property, or building owner as there would be from an inadequate fire protection design. This annex is intended to only cover security systems. A description of physical security elements can be found in A.9.10. Security systems for the purpose of this Annex can be separated into three broad categories:

- (1) Intrusion Detection
- (2) Access Control
- (3) Closed Circuit TV

**U.2 Intrusion Detection.** Intrusion detection systems can protect both the exterior and interior of premises. A vulnerability assessment should be performed to determine the level of detection to be provided.

**U.2.1 Exterior Detection.** Exterior sensors should have a high probability of detection for all types of intrusion and a low unwanted-alarm rate for all expected environmental and site conditions. The designer, in addition to the threat and risk assessment, needs to take into consideration the cost of the detection, both the equipment and its installation, as well as the cost of maintaining the equipment after the installation. [See Table U.2.1(a) and Table U.2.1(b).]

Consideration should also be given to the local environment and the probability of the system having false alarms due to the detection device(s) that were installed. [See Table U.2.1(c).]

Exterior devices include:

- (1) Audio
- (2) Contacts
- (3) Motion detection
- (4) Fence strain systems
- (5) Electric-field systems
- (6) Capacitance-sensor system
- (7) Leaky coaxial
- (8) Stress sensors
- (9) Shock sensors
- (10) Photoelectric cell

**U.2.1.1 Audio.** Audio or sound detectors can be used effectively to protect enclosed areas, vaults, warehouses, and similar enclosures. Microphone speaker sensors are installed on walls and ceilings of the protected area. The sensitivity of the system can be adjusted.

**U.2.1.2 Contacts.** Contacts should be listed in accordance with ANSI/UL 634, *Standard for Connectors and Switches for Use with Burglar-Alarm Systems*. Depending on the application, the designer may use either a flush or surface contact. The contact may be “balanced” for high security or “wide-gap” if used on a large door or fence. The designer should consult with the manufacturer of the contact to specify the proper contact application.

**U.2.1.3 Motion Detection.** The principal type of motion detection used for exterior detection is the microwave. Microwave detection sensors are categorized as bistatic or monostatic.

**Table U.2.1(a) Sensor Performance—Probability of Detection by Exterior Sensors**

Type of Sensor	Intruder Technique											
	Slow walk	Walking	Running	Crawling	Rolling	Jumping	Tunneling	Trenching	Bridging	Cutting	Climbing	Lifting
Fence mounted	N/A	N/A	N/A	N/A	N/A	VH	VL	L	VL	M/H	H	M/H
Taut wire	N/A	N/A	N/A	N/A	N/A	VH	VL	VL	VL	H	H	H
Electric field	VH	VH	VH	H	VH	VH	VL	L	L	N/A	N/A	N/A
Capacitance	VH	VH	VH	H	H	VH	VL	L	L	N/A	N/A	N/A
Ported cable	H	VH	VH	VH	VH	H	M	VH	L	N/A	N/A	N/A
Seismic	H	VH	H	M	M	M	L	M	L	N/A	N/A	N/A
Seismic/ magnetic	H	VH	H	M	M	M	L	M	L	N/A	N/A	N/A
Microwave	H	VH	H	M/H	M/H	M/H	VL	L/M	L	N/A	N/A	N/A
IR	VH	VH	VH	M/H	M/H	H	VL	L	VL	N/A	N/A	N/A
Video motion	H	VH	VH	H	H	H	VL	L/M	M	N/A	N/A	N/A

VL = very low, L = low, M = medium, H = high, VH = very high, N/A = not applicable

Source: Field Manual FM-3-19.30, *Physical Security*, Headquarters, Department of the Army, 2001, Table 6-1.

Bistatic sensors use transmitting and receiving antennas located at opposite ends of the microwave link. Monostatic use the same antenna.

Care should be taken when selecting a microwave detection system so that the field of detection does not extend beyond the area to be covered. Microwave energy can extend beyond the intended target area and cause false alarms from movement outside of the field of coverage. (See Figure U.2.1.3.)

**U.2.1.4 Fence-Strain System.** The fence-strain system uses cables as transducers that are uniformly sensitive along their entire length. They generate an analog voltage when subject to mechanical distortions or stress resulting from fence motion. (See Figure U.2.1.4.)

**U.2.1.5 Electric-Field System.** An electric-field system consists of an alternating-current field generator, one or more field wires and one or more sensing wires, and a signal processor. The generator excites the field wires around which an electrostatic field pattern is created. The electrostatic field induces electrical signals in the sense wires, which are monitored by the signal processor. (See Figure U.2.1.5.)

**U.2.1.6 Capacitance-Sensor System.** A capacitance-sensor or proximity sensor measures the electrical capacitance between the ground and an array of sense wires. Any change in capacitance caused by an intruder approaching or touching one or more of the sense wires initiates an alarm. (See Figure U.2.1.6.)

**U.2.1.7 Leaky Coaxial Cable System.** Leaky coaxial cable (LCX) has been used for a number of years for perimeter protection. This method is also referred to as a ported system. The system involves lining the perimeter with two parallel LCX cables buried just below the surface of the ground. The depth is determined by the manufacturer and coverage the designer wishes to obtain. These cables are generally buried in soil, but can also be placed underneath asphalt or concrete.

The LCX cable is slotted or ported so as to allow RF energy to be released. Two LCX cables are run in parallel, one for transmission and the second for receiving. This generates a constant volume of an electric magnetic (EM) field above the ground. Movement of objects within the EM field will cause a disturbance, leading to an alarm activation. (See Figure U.2.1.7.)

**Table U.2.1(b) Economic Considerations**

Type of Sensor	Equipment	Installation	Maintenance
Fence mounted	L	L	L
Taut wire	H	H	M
Electric field	H	M	M
Capacitance	M	L	M
Ported cable	H	M	M
Seismic	M	M	L
Seismic/magnetic	H	M	L
Microwave	M	M	L
IR	M	L	M
Video motion	M	L	M

L = low, M = medium, H = high

Source: Field Manual FM-3-19.30, *Physical Security*, Headquarters, Department of the Army, 2001, Table 6-3.

#### U.2.1.8 Stress Sensor. (Reserved)

#### U.2.1.9 Shock Sensor. (Reserved)

#### U.2.1.10 Photoelectric Cell. (Reserved)

**U.2.2 Interior Detection.** Interior detection includes both perimeter and space detection. Perimeter detection is installed along the perimeter of the premises — doors, windows, walls, and roofs. Space detection provides coverage within the interior or space of the premises. (See Table U.2.2.)

Interior devices include the following:

- (1) Protective wiring
- (2) Foil
- (3) Traps
- (4) Contacts
- (5) Shock sensors
- (6) Glass break sensors
- (7) Sound detectors
- (8) Motion detectors
- (9) Photoelectric cells

**U.2.2.1 Protective Wiring.** Protective wiring is primarily found in older systems. The designer may find these methods useful for the protection of vents, skylights, and high windows.